

TOSHIBA
Leading Innovation >>>

**AIR CONDITIONER (MULTI TYPE)
Installation Manual**



Indoor Unit

Model name:

4-way Cassette Type

- MMU-AP0094HP-E**
- MMU-AP0124HP-E**
- MMU-AP0154HP-E**
- MMU-AP0184HP-E**
- MMU-AP0244HP-E**
- MMU-AP0274HP-E**
- MMU-AP0304HP-E**
- MMU-AP0364HP-E**
- MMU-AP0484HP-E**
- MMU-AP0564HP-E**

For commercial use

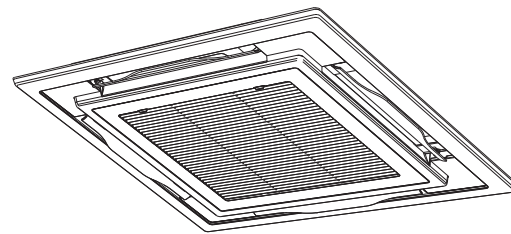

English

Original instruction

Please read this Installation Manual carefully before installing the Air Conditioner.

- This Manual describes the installation method of the indoor unit.
- For installation of the outdoor unit, follow the Installation Manual attached to the outdoor unit.

ADOPTION OF NEW REFRIGERANT

This Air Conditioner uses R410A an environmentally friendly refrigerant.

„Maschinenlärminformations-Verordnung - 3. GPSGV, der höchste Schalldruckpegel beträgt 70 dB(A) oder weniger gemäss EN ISO 7779.“

- 1 -

Contents

1	Precautions for safety	3
1	Précautions de sécurité	6
1	Vorsichtsmaßnahmen für die Sicherheit	9
1	Precauzioni per la sicurezza	12
1	Precauciones de seguridad	15
1	Precauções de segurança	18
1	Voorzorgen voor de veiligheid	21
1	Προφυλάξεις για ασφάλεια	24
1	Меры предосторожности	27
1	Güvenlik Önlemleri	30
2	Accessory parts	32
3	Selection of installation place	32
4	Installation	34
5	Drain piping	36
6	Refrigerant piping	37
7	Electrical connection	38
8	Applicable controls	41
9	Test run	43
10	Maintenance	44
11	Troubleshooting	46
12	Specifications	51

Thank you for purchasing this Toshiba air conditioner.

Please read carefully through these instructions that contain important information which complies with the "Machinery" Directive (Directive 2006/42/EC), and ensure that you understand them.

After completing the installation work, hand over this Installation Manual as well as the Owner's Manual provided with the outdoor unit to the user, and ask the user to keep them in a safe place for future reference.

Generic Denomination: Air Conditioner

Definition of Qualified Installer or Qualified Service Person

The air conditioner must be installed, maintained, repaired and removed by a qualified installer or qualified service person. When any of these jobs is to be done, ask a qualified installer or qualified service person to do them for you. A qualified installer or qualified service person is an agent who has the qualifications and knowledge described in the table below.

Agent	Qualifications and knowledge which the agent must have
Qualified installer	<ul style="list-style-type: none"> The qualified installer is a person who installs, maintains, relocates and removes the air conditioners made by Toshiba Carrier Corporation. He or she has been trained to install, maintain, relocate and remove the air conditioners made by Toshiba Carrier Corporation or, alternatively, he or she has been instructed in such operations by an individual or individuals who have been trained and is thus thoroughly acquainted with the knowledge related to these operations. The qualified installer who is allowed to do the electrical work involved in installation, relocation and removal has the qualifications pertaining to this electrical work as stipulated by the local laws and regulations, and he or she is a person who has been trained in matters relating to electrical work on the air conditioners made by Toshiba Carrier Corporation or, alternatively, he or she has been instructed in such matters by an individual or individuals who have been trained and is thus thoroughly acquainted with the knowledge related to this work. The qualified installer who is allowed to do the refrigerant handling and piping work involved in installation, relocation and removal has the qualifications pertaining to this refrigerant handling and piping work as stipulated by the local laws and regulations, and he or she is a person who has been trained in matters relating to refrigerant handling and piping work on the air conditioners made by Toshiba Carrier Corporation or, alternatively, he or she has been instructed in such matters by an individual or individuals who have been trained and is thus thoroughly acquainted with the knowledge related to this work. The qualified installer who is allowed to work at heights has been trained in matters relating to working at heights with the air conditioners made by Toshiba Carrier Corporation or, alternatively, he or she has been instructed in such matters by an individual or individuals who have been trained and is thus thoroughly acquainted with the knowledge related to this work.
Qualified service person	<ul style="list-style-type: none"> The qualified service person is a person who installs, repairs, maintains, relocates and removes the air conditioners made by Toshiba Carrier Corporation. He or she has been trained to install, repair, maintain, relocate and remove the air conditioners made by Toshiba Carrier Corporation or, alternatively, he or she has been instructed in such operations by an individual or individuals who have been trained and is thus thoroughly acquainted with the knowledge related to these operations. The qualified service person who is allowed to do the electrical work involved in installation, repair, relocation and removal has the qualifications pertaining to this electrical work as stipulated by the local laws and regulations, and he or she is a person who has been trained in matters relating to electrical work on the air conditioners made by Toshiba Carrier Corporation or, alternatively, he or she has been instructed in such matters by an individual or individuals who have been trained and is thus thoroughly acquainted with the knowledge related to this work. The qualified service person who is allowed to do the refrigerant handling and piping work involved in installation, repair, relocation and removal has the qualifications pertaining to this refrigerant handling and piping work as stipulated by the local laws and regulations, and he or she is a person who has been trained in matters relating to refrigerant handling and piping work on the air conditioners made by Toshiba Carrier Corporation or, alternatively, he or she has been instructed in such matters by an individual or individuals who have been trained and is thus thoroughly acquainted with the knowledge related to this work. The qualified service person who is allowed to work at heights has been trained in matters relating to working at heights with the air conditioners made by Toshiba Carrier Corporation or, alternatively, he or she has been instructed in such matters by an individual or individuals who have been trained and is thus thoroughly acquainted with the knowledge related to this work.

Definition of Protective Gear





When the air conditioner is to be transported, installed, maintained, repaired or removed, wear protective gloves and 'safety' work clothing.

In addition to such normal protective gear, wear the protective gear described below when undertaking the special work detailed in the table below.

Failure to wear the proper protective gear is dangerous because you will be more susceptible to injury, burns, electric shocks and other injuries.

Work undertaken	Protective gear worn
All types of work	Protective gloves 'Safety' working clothing
Electrical-related work	Gloves to provide protection for electricians and from heat Insulating shoes Clothing to provide protection from electric shock
Work done at heights (50 cm or more)	Helmets for use in industry
Transportation of heavy objects	Shoes with additional protective toe cap
Repair of outdoor unit	Gloves to provide protection for electricians and from heat

■ Warning indications on the air conditioner unit

Warning indication		Description
	<p>WARNING</p> <p>ELECTRICAL SHOCK HAZARD Disconnect all remote electric power supplies before servicing.</p>	<p>WARNING</p> <p>ELECTRICAL SHOCK HAZARD Disconnect all remote electric power supplies before servicing.</p>
	<p>WARNING</p> <p>Moving parts. Do not operate unit with grille removed. Stop the unit before the servicing.</p>	<p>WARNING</p> <p>Moving parts. Do not operate unit with grille removed. Stop the unit before the servicing.</p>
	<p>CAUTION</p> <p>High temperature parts. You might get burned when removing this panel.</p>	<p>CAUTION</p> <p>High temperature parts. You might get burned when removing this panel.</p>
	<p>CAUTION</p> <p>Do not touch the aluminum fins of the unit. Doing so may result in injury.</p>	<p>CAUTION</p> <p>Do not touch the aluminium fins of the unit. Doing so may result in injury.</p>
	<p>CAUTION</p> <p>BURST HAZARD Open the service valves before the operation, otherwise there might be the burst.</p>	<p>CAUTION</p> <p>BURST HAZARD Open the service valves before the operation, otherwise there might be the burst.</p>

1 Precautions for safety

The manufacturer shall not assume any liability for the damage caused by not observing the description of this manual.

WARNING

General

- Before starting to install the air conditioner, read through the Installation Manual carefully, and follow its instructions to install the air conditioner.
- Only a qualified installer or service person is allowed to do installation work. Inappropriate installation may result in water leakage, electric shock or fire.
- Do not use any refrigerant different from the one specified for complement or replacement. Otherwise, abnormally high pressure may be generated in the refrigeration cycle, which may result in a failure or explosion of the product or an injury to your body.
- Before opening the intake grille of the indoor unit or service panel of the outdoor unit, set the circuit breaker to the OFF position. Failure to set the circuit breaker to the OFF position may result in electric shocks through contact with the interior parts. Only a qualified installer or qualified service person is allowed to remove the intake grille of the indoor unit or service panel of the outdoor unit and do the work required.
- Before carrying out the installation, maintenance, repair or removal work, set the circuit breaker to the OFF position. Otherwise, electric shocks may result.
- Place a "Work in progress" sign near the circuit breaker while the installation, maintenance, repair or removal work is being carried out. There is a danger of electric shocks if the circuit breaker is set to ON by mistake.
- Only a qualified installer or qualified service person is allowed to undertake work at heights using a stand of 50 cm or more or to remove the intake grille of the indoor unit to undertake work.
- Wear protective gloves and safety work clothing during installation, servicing and removal.
- Do not touch the aluminium fin of the unit. You may injure yourself if you do so. If the fin must be touched for some reason, first put on protective gloves and safety work clothing, and then proceed.
- Do not climb onto or place objects on top of the outdoor unit. You may fall or the objects may fall off of the outdoor unit and result in injury.
- When work is performed at heights, use a ladder which complies with the ISO 14122 standard, and follow the procedure in the ladder's instructions. Also wear a helmet for use in industry as protective gear to undertake the work.
- Before cleaning the filter or other parts of the outdoor unit, set the circuit breaker to OFF without fail, and place a "Work in progress" sign near the circuit breaker before proceeding with the work.
- Before working at heights, put a sign in place so that no-one will approach the work location, before proceeding with the work. Parts and other objects may fall from above, possibly injuring a person below. While carrying out the work, wear a helmet for protection from falling objects.
- The refrigerant used by this air conditioner is the R410A.
- The air conditioner must be transported in stable condition. If any part of the product is broken, contact the dealer.
- When the air conditioner must be transported by hand, carry it by two or more people.
- Do not move or repair any unit by yourself. There is high voltage inside the unit. You may get electric shock when removing the cover and main unit.

Selection of installation location

- When the air conditioner is installed in a small room, provide appropriate measures to ensure that the concentration of refrigerant leakage occur in the room does not exceed the critical level.
- Do not install in a location where flammable gas leaks are possible. If the gas leak and accumulate around the unit, it may ignite and cause a fire.
- To transport the air conditioner, wear shoes with additional protective toe caps.
- To transport the air conditioner, do not take hold of the bands around the packing carton. You may injure yourself if the bands should break.
- Install the indoor unit at least 2.5 m above the floor level since otherwise the users may injure themselves or receive electric shocks if they poke their fingers or other objects into the indoor unit while the air conditioner is running.
- Do not place any combustion appliance in a place where it is directly exposed to the wind of air conditioner, otherwise it may cause imperfect combustion.

Installation

- When the indoor unit is to be suspended, the designated hanging bolts (M10 or W3/8) and nuts (M10 or W3/8) must be used.
- Install the air conditioner securely in a location where the base can sustain the weight adequately. If the strength is not enough, the unit may fall down resulting in injury.
- Follow the instructions in the Installation Manual to install the air conditioner. Failure to follow these instructions may cause the product to fall down or topple over or give rise to noise, vibration, water leakage or other trouble.
- Carry out the specified installation work to guard against the possibility of high winds and earthquake. If the air conditioner is not installed appropriately, a unit may topple over or fall down, causing an accident.
- If refrigerant gas has leaked during the installation work, ventilate the room immediately. If the leaked refrigerant gas comes in contact with fire, noxious gas may generate.
- Use forklift to carry in the air conditioner units and use winch or hoist at installation of them.

Refrigerant piping

- Install the refrigerant pipe securely during the installation work before operating the air conditioner. If the compressor is operated with the valve open and without refrigerant pipe, the compressor sucks air and the refrigeration cycles is over pressurized, which may cause an injury.
- Tighten the flare nut with a torque wrench in the specified manner. Excessive tighten of the flare nut may cause a crack in the flare nut after a long period, which may result in refrigerant leakage.
- After the installation work, confirm that refrigerant gas does not leak. If refrigerant gas leaks into the room and flows near a fire source, such as a cooking range, noxious gas may be generated.
- When the air conditioner has been installed or relocated, follow the instructions in the Installation Manual and purge the air completely so that no gases other than the refrigerant will be mixed in the refrigerating cycle. Failure to purge the air completely may cause the air conditioner to malfunction.
- Nitrogen gas must be used for the airtight test.
- The charge hose must be connected in such a way that it is not slack.

Electrical wiring

- Only a qualified installer or qualified service person is allowed to carry out the electrical work of the air conditioner. Under no circumstances must this work be done by an unqualified individual since failure to carry out the work properly may result in electric shocks and/or electrical leaks.
- To connect the electrical wires, repair the electrical parts or undertake other electrical jobs, wear gloves to provide protection for electricians and from heat, insulating shoes and clothing to provide protection from electric shocks. Failure to wear this protective gear may result in electric shocks.
- Use wiring that meets the specifications in the Installation Manual and the stipulations in the local regulations and laws. Use of wiring which does not meet the specifications may give rise to electric shocks, electrical leakage, smoking and/or a fire.
- Connect earth wire. (Grounding work)
Incomplete grounding causes an electric shock.
- Do not connect earth wires to gas pipes, water pipes, and lightning conductor or telephone earth wires.
- After completing the repair or relocation work, check that the earth wires are connected properly.
- Install a circuit breaker that meets the specifications in the installation manual and the stipulations in the local regulations and laws.
- Install the circuit breaker where it can be easily accessed by the agent.
- When installing the circuit breaker outdoors, install one which is designed to be used outdoors.
- Under no circumstances the power wire must not be extended. Connection trouble in the places where the wire is extended may give rise to smoking and/or a fire.
- Electrical wiring work shall be conducted according to law and regulation in the community and installation manual. Failure to do so may result in electrocution or short circuit.

Test run

- Before operating the air conditioner after having completed the work, check that the electrical control box cover of the indoor unit and service panel of the outdoor unit are closed, and set the circuit breaker to the ON position. You may receive an electric shock if the power is turned on without first conducting these checks.
- If there is any kind of trouble (such as an error display has appeared, smell of burning, abnormal sounds, the air conditioner fails to cool or heat or water is leaking) has occurred in the air conditioner, do not touch the air conditioner yourself but set the circuit breaker to the OFF position, and contact a qualified service person. Take steps to ensure that the power will not be turned on (by marking "out of service" near the circuit breaker, for instance) until qualified service person arrives. Continuing to use the air conditioner in the trouble status may cause mechanical problems to escalate or result in electric shocks or other trouble.
- After the work has finished, use an insulation tester set (500 V Megger) to check the resistance is 1 MΩ or more between the charge section and the non-charge metal section (Earth section). If the resistance value is low, a disaster such as a leak or electric shock is caused at user's side.
- Upon completion of the installation work, check for refrigerant leaks and check the insulation resistance and water drainage. Then conduct a test run to check that the air conditioner is operating properly.

Explanations given to user

- Upon completion of the installation work, tell the user where the circuit breaker is located. If the user does not know where the circuit breaker is, he or she will not be able to turn it off in the event that trouble has occurred in the air conditioner.
- If the fan grille is damaged, do not approach the outdoor unit but set the circuit breaker to the OFF position, and contact a qualified service person to have the repairs done. Do not set the circuit breaker to the ON position until the repairs are completed.
- After the installation work, follow the Owner's Manual to explain to the customer how to use and maintain the unit.

Relocation

- Only a qualified installer or qualified service person is allowed to relocate the air conditioner. It is dangerous for the air conditioner to be relocated by an unqualified individual since a fire, electric shocks, injury, water leakage, noise and/or vibration may result.
- When carrying out the pump-down work shut down the compressor before disconnecting the refrigerant pipe. Disconnecting the refrigerant pipe with the service valve left open and the compressor still operating will cause air or other gas to be sucked in, raising the pressure inside the refrigeration cycle to an abnormally high level, and possibly resulting in rupture, injury or other trouble.

CAUTION

New refrigerant air conditioner installation

- **This air conditioner adopts the new HFC refrigerant (R410A) which does not destroy ozone layer.**
- The characteristics of R410A refrigerant are; easy to absorb water, oxidizing membrane or oil, and its pressure is approx. 1.6 times higher than that of refrigerant R22. Accompanied with the new refrigerant, refrigerating oil has also been changed. Therefore, do not let water, dust, former refrigerant, or refrigerating oil enter the refrigerating cycle during installation work.
- To prevent charging an incorrect refrigerant and refrigerating oil, the sizes of connecting sections of charging port of the main unit and installation tools are changed from those for the conventional refrigerant.
- Accordingly the exclusive tools are required for the new refrigerant (R410A).
- For connecting pipes, use new and clean piping designed for R410A, and please care so that water or dust does not enter.

To disconnect the appliance from main power supply.

- This appliance must be connected to the main power supply by means of a switch with a contact separation of at least 3 mm.

The installation fuse (all types can be used) must be used for the power supply line of this conditioner.

(*1) Refer to the "Definition of Qualified Installer or Qualified Service Person."

Merci d'avoir acheté ce climatiseur Toshiba.

Veillez lire attentivement ces instructions qui contiennent des informations importantes qui sont conformes à la directive « Machines » (Directive 2006/42/EC), et assurez-vous de bien les comprendre.

Après avoir terminé l'installation, remettez le manuel d'installation ainsi que le manuel d'utilisation fourni avec l'unité extérieure à l'utilisateur, et demandez à l'utilisateur de le conserver dans un endroit sûr pour pouvoir le consulter en cas de besoin.

Dénomination générique : Climatiseur

Définition d'un Installateur qualifié ou Technicien d'entretien qualifié

Le climatiseur doit être installé, entretenu, réparé et enlevé par un installateur qualifié ou une personne d'entretien qualifiée. Lorsqu'une de ces opérations doit être effectuée, demandez à un installateur qualifié ou un technicien d'entretien qualifié de les exécuter pour vous.

Un installateur qualifié ou technicien d'entretien qualifié est un agent qui a les qualifications et connaissances décrites dans le tableau ci-dessous.

Agent	Qualifications et connaissances que cet agent doit posséder
Installateur qualifié	<ul style="list-style-type: none"> L'installateur qualifié est une personne qui installe, entretient, déplace et enlève les climatiseurs fabriqués par Toshiba Carrier Corporation. Il ou elle a été formé pour installer, entretenir, déplacer et enlever les climatiseurs fabriqués par Toshiba Carrier Corporation ou, alternativement, il ou elle a reçu des consignes concernant de telles opérations par une ou des personnes qui ont été formés et a, par conséquent, acquis toutes les connaissances associées à ces opérations. L'installateur qualifié qui est autorisé à effectuer un travail électrique compris dans l'installation, le déplacement et l'enlèvement possède les qualifications nécessaires à ce travail électrique conformément aux réglementations et à la législation locales, et il ou elle est une personne qui a été formée pour les problèmes relatifs au travail électrique sur les climatiseurs fabriqués par Toshiba Carrier Corporation ou, alternativement, il ou elle a reçu des consignes dans de tels domaines par une ou des personnes qui ont été formées et possèdent, par conséquent, les connaissances relatives à ce travail. L'installateur qualifié qui est autorisé à manipuler du fluide frigorigène et à réaliser un travail de raccordement compris dans l'installation, le déplacement et l'enlèvement possède les qualifications nécessaires à cette manipulation de fluide frigorigène et de ce travail de raccordement conformément aux réglementations et à la législation locales, et il ou elle est une personne qui a été formée pour les problèmes relatifs à la manipulation de fluide frigorigène et de travail de raccordement sur les climatiseurs fabriqués par Toshiba Carrier Corporation ou, alternativement, il ou elle a reçu des consignes dans de tels domaines par une ou des personnes qui ont été formées et possèdent, par conséquent, les connaissances relatives à ce travail. L'installateur qualifié qui est autorisé à travailler en hauteur a été formé aux domaines relatifs au travail en hauteur avec les climatiseurs fabriqués par Toshiba Carrier Corporation ou, alternativement, il ou elle a reçu des consignes dans de tels domaines par une ou des personnes qui ont été formées et possèdent, par conséquent, toutes les connaissances requises pour ce travail.
Technicien d'entretien qualifié	<ul style="list-style-type: none"> La personne d'entretien qualifiée est une personne qui installe, répare, entretient, déplace et enlève les climatiseurs fabriqués par Toshiba Carrier Corporation. Il ou elle a été formé pour installer, réparer, entretenir, déplacer et enlever les climatiseurs fabriqués par Toshiba Carrier Corporation ou, alternativement, il ou elle a reçu des consignes pour de telles opérations par une ou des personnes qui ont été formées et a, par conséquent, acquis toutes les connaissances associées à ces opérations. La personne d'entretien qualifiée qui est autorisée à effectuer un travail électrique compris dans l'installation, la réparation, le déplacement et l'enlèvement possède les qualifications nécessaires à ce travail électrique conformément aux réglementations et à la législation locales, et il ou elle est une personne qui a été formée pour les problèmes relatifs au travail électrique sur les climatiseurs fabriqués par Toshiba Carrier Corporation ou, alternativement, il ou elle a reçu des consignes dans de tels domaines par une ou des personnes qui ont été formées et possèdent, par conséquent, les connaissances relatives à ce travail. La personne d'entretien qualifiée qui est autorisée à manipuler du fluide frigorigène et à réaliser un travail de raccordement compris dans l'installation, la réparation, le déplacement et l'enlèvement possède les qualifications nécessaires à cette manipulation de fluide frigorigène et de ce travail de raccordement conformément aux réglementations et à la législation locales, et il ou elle est une personne qui a été formée pour les problèmes relatifs à la manipulation de fluide frigorigène et de travail de raccordement sur les climatiseurs fabriqués par Toshiba Carrier Corporation ou, alternativement, il ou elle a reçu des consignes dans de tels domaines par une ou des personnes qui ont été formées et possèdent, par conséquent, les connaissances relatives à ce travail. La personne d'entretien qualifiée qui est autorisée à travailler en hauteur a été formé aux domaines relatifs au travail en hauteur avec les climatiseurs fabriqués par Toshiba Carrier Corporation ou, alternativement, il ou elle a reçu des consignes dans de tels domaines par un ou des personnes qui ont été formées et possèdent, par conséquent, toutes les connaissances requises pour ce travail.

Définition de l'équipement de protection





Lorsque le climatiseur doit être transporté, installé, entretenu, réparé ou enlevé, portez des gants de protection et des vêtements de travail de "sécurité".

En plus de cette tenue de protection normale, portez la tenue de protection décrite ci-dessous lorsque vous entreprenez les travaux spéciaux détaillés dans le tableau ci-dessous.

Ne pas porter la tenue de protection adéquate est dangereux car vous serez plus susceptible d'être blessé, brûlé, de subir un choc électrique ou d'autres blessures.

Travaux entrepris	Equipement de protection porté
Tous types de travaux	Gants de protection Vêtement de travail de "Sécurité"
Travaux liés à l'électricité	Gants pour fournir une protection contre les décharges électriques et la chaleur Chaussures isolantes Vêtement protégeant d'un choc électrique
Travail effectué en hauteur (50 cm minimum)	Casques utilisés dans l'industrie
Transport d'objets lourds	Chaussures avec des bouts renforcés de protection
Réparation de l'unité extérieure	Gants pour fournir une protection contre les décharges électriques et la chaleur

■ Avertissements apposés sur le climatiseur

Indication d'avertissement		Description
	<p>WARNING</p> <p>ELECTRICAL SHOCK HAZARD Disconnect all remote electric power supplies before servicing.</p>	<p>AVERTISSEMENT</p> <p>RISQUE DE DECHARGE ELECTRIQUE Débranchez toutes les alimentations électriques distantes avant l'entretien.</p>
	<p>WARNING</p> <p>Moving parts. Do not operate unit with grille removed. Stop the unit before the servicing.</p>	<p>AVERTISSEMENT</p> <p>Pièces mobiles. Ne faites pas fonctionner l'unité avec la grille déposée. Arrêtez l'unité avant l'entretien.</p>
	<p>CAUTION</p> <p>High temperature parts. You might get burned when removing this panel.</p>	<p>PRÉCAUTION</p> <p>Pièces à haute température. Vous pourriez vous brûler en déposant ce panneau.</p>
	<p>CAUTION</p> <p>Do not touch the aluminum fins of the unit. Doing so may result in injury.</p>	<p>PRÉCAUTION</p> <p>Ne touchez pas les palmes en aluminium de l'unité. Vous pourriez vous blesser.</p>
	<p>CAUTION</p> <p>BURST HAZARD Open the service valves before the operation, otherwise there might be the burst.</p>	<p>PRÉCAUTION</p> <p>RISQUE D'EXPLOSION Ouvrez les soupapes de service avant l'opération, sinon un éclatement pourrait se produire.</p>

1 Précautions de sécurité

Le fabricant ne peut être tenu responsable pour tout dommage causé par le non respect des instructions et descriptions de ce manuel.

AVERTISSEMENT

Généralités

- Avant d'installer le climatiseur, lisez attentivement le Manuel d'installation et suivez les instructions pour installer le climatiseur.
- Seul un installateur qualifié ou une personne d'entretien est autorisé à procéder à l'installation. Une installation inadéquate peut se solder par une fuite d'eau, une électrocution ou un incendie.
- N'utilisez aucun autre réfrigérant que celui spécifié pour tout rajout ou remplacement. Sinon, une haute pression anormale pourrait être générée dans le circuit de réfrigération, qui pourrait entraîner une panne ou une explosion du produit ou même des blessures corporelles.
- Avant d'ouvrir la grille d'entrée d'air de l'unité intérieure ou du panneau de service de l'unité extérieure, réglez le disjoncteur sur la position OFF. Ne pas régler le disjoncteur sur la position OFF peut donner lieu à des chocs électriques par le biais d'un contact avec les pièces intérieures. Seul un installateur qualifié(*1) ou une personne d'entretien qualifiée(*1) est autorisé à enlever la grille d'entrée d'air de l'unité intérieure ou le panneau de service de l'unité extérieure et à effectuer le travail requis.
- Avant de procéder à l'installation, à l'entretien, à la réparation ou à la dépose, réglez le coupe-circuit en position OFF. Dans le cas contraire, cela peut entraîner des chocs électriques.
- Placez un panneau indicateur "Travail en cours" à proximité du coupe-circuit pendant l'installation, l'entretien, la réparation ou la dépose. Un danger de choc électrique est possible si le coupe-circuit est réglé sur ON par erreur.
- Seul un installateur qualifié(*1) ou une personne d'entretien qualifiée(*1) est autorisé à entreprendre un travail en hauteur à l'aide d'un pied de 50 cm minimum pour déposer la grille d'entrée d'air de l'unité intérieure pour entreprendre le travail.
- Portez des gants de protection ainsi que des vêtements de travail de sécurité pendant l'installation, l'entretien et la dépose.
- Ne touchez pas la palme en aluminium de l'unité. Vous risquez de vous blesser dans le cas contraire. Si vous devez toucher la palme pour une raison ou une autre, mettez d'abord des gants de protection et des vêtements de travail de sécurité, ensuite, procédez à l'opération.
- Ne grimpez pas ou ne placez pas d'objets sur le dessus de l'unité extérieure. Vous ou les objets pourriez tomber de l'unité extérieure et ainsi vous blesser.
- Lors de la réalisation d'un travail en hauteur, utilisez une échelle conforme à la norme ISO 14122 et suivez la procédure associée aux instructions de l'échelle. Portez également un casque de protection pour une utilisation dans l'industrie comme tenue de protection pour entreprendre le travail.
- Avant le nettoyage du filtre ou d'autres pièces de l'unité extérieure, réglez le coupe-circuit sur OFF sans faute, et placez un panneau indicateur "Travail en cours" à proximité du coupe-circuit avec de commencer le travail.
- Avant de travailler en hauteur, placez un panneau indicateur afin que personne ne s'approche du lieu de travail. Des pièces et d'autres objets risquent de tomber du haut, pouvant blesser une personne se trouvant en dessous. Pendant toute la durée de la tâche, portez un casque, afin d'être protégé en cas de chute d'objets.
- Le fluide frigorigène utilisé par ce climatiseur est le R410A.
- Le climatiseur doit être transporté dans des conditions stables. Si une pièce était endommagée, contactez le revendeur.
- Si le climatiseur doit être transporté à la main, faites appel à plusieurs personnes.
- Ne déplacez ni ne réparez l'unité vous-même. L'intérieur de l'unité est sous haute tension. Vous risqueriez un choc électrique en enlevant le couvercle et l'unité principale.

Sélection du lieu d'installation

- Si le climatiseur est installé dans une petite pièce, prenez les mesures qui s'imposent pour que, en cas de fuite, la teneur en réfrigérant ne dépasse pas le seuil critique.
- N'installez pas cet appareil dans un endroit où des fuites de gaz inflammable sont possibles. En cas de fuite du gaz et d'accumulation à proximité du climatiseur, un incendie peut se déclarer.
- Lors du transport du climatiseur, portez des chaussures à coquilles de protection supplémentaires.
- Lors du transport du climatiseur, n'agrippez pas les bandes du carton d'emballage. Vous risquez de vous blesser si les bandes se brisent.
- Installez l'unité intérieure à au moins 2,5 m au dessus du niveau du sol, dans le cas contraire, les utilisateurs peuvent se blesser ou recevoir des chocs électriques s'ils frappent de leurs doigts ou d'autres objets dans l'unité intérieure alors que le climatiseur fonctionne.
- Ne placez aucun appareil à combustion dans un endroit exposé directement au souffle du climatiseur, faute de quoi sa combustion risquerait d'être déficiente.

Installation

- Lorsque l'unité intérieure doit être suspendue, les boulons (M10 ou W3/8) et les écrous (M10 ou W3/8) de suspension désignés doivent être utilisés.
- Installez soigneusement le climatiseur sur une base capable de le supporter. Si l'endroit n'est pas assez résistant, l'unité peut tomber et provoquer des blessures.
- Suivez les instructions du Manuel d'installation pour installer le climatiseur. Le non-respect de ces instructions peut entraîner la chute ou le basculement de l'appareil, voire engendrer du bruit, des vibrations, une fuite d'eau, etc.
- Effectuez l'installation spécifiée pour protéger le climatiseur contre un tremblement de terre ou des vents violents. S'il n'est pas correctement monté, le climatiseur risque de tomber ou de basculer, ce qui peut entraîner un accident.
- Si le gaz réfrigérant a fui durant l'installation, aérez immédiatement la pièce. Si le gaz réfrigérant qui a fui entre en contact avec le feu, un gaz nocif peut se dégager.
- Utilisez un chariot élévateur pour porter le climatiseur. Pour le monter, utilisez un treuil ou un monte-charge.

Tuyaux de réfrigérant

- Fixez solidement le tuyau de réfrigérant pendant l'installation, avant de faire fonctionner le climatiseur. Si le compresseur est utilisé avec la vanne ouverte et sans que le tuyau de réfrigérant ne soit connecté, le compresseur aspire l'air et le circuit de réfrigération est alors en surpression. Dans ce cas, les tuyaux risquent de blesser quelqu'un.
- Serrez l'écrou évasé avec une clé dynamométrique de la manière spécifiée. Si vous appliquez un couple excessif, l'écrou risque, après un certain temps, de se casser et de provoquer une fuite de réfrigérant.
- Après l'installation, assurez-vous que le gaz réfrigérant ne fuit pas. Si le gaz réfrigérant fuit dans la pièce et s'écoule à proximité d'une source inflammable, telle qu'une cuisinière, un gaz nocif peut se dégager.
- Lorsque le climatiseur a été installé ou déplacé, suivez les instructions du Manuel d'installation et purgez la totalité de l'air de sorte qu'aucun gaz autre que le fluide frigorigène ne soit mélangé dans le circuit de réfrigération. Ne pas purger complètement l'air peut entraîner un dysfonctionnement du climatiseur.
- De l'azote gazeux doit être utilisé pour le test d'étanchéité à l'air.
- Le tuyau de remplissage doit être raccordé de telle manière qu'il ne soit pas lâche.

Raccordement électrique

- Seul un installateur qualifié(*1) ou une personne d'entretien qualifiée(*1) est autorisé à réaliser le travail électrique sur le climatiseur. En aucun cas, ce travail doit être effectué par une personne non qualifiée étant donné que si le travail n'est pas correctement effectué, des chocs électriques et/ou des fuites électriques peuvent survenir.
- Lors du raccordement des câbles électriques, de la réparation des pièces électriques ou de l'exécution d'autres travaux électriques, portez des gants pour vous protéger du courant et de la chaleur, ainsi que des chaussures et des vêtements isolants pour vous protéger de chocs électriques. Ne pas porter cette tenue de protection peut entraîner des chocs électriques.
- Utilisez un câblage respectant les spécifications du Manuel d'installation et les dispositions des réglementations et de la législation locales. L'utilisation d'un câblage n'étant pas conforme aux spécifications peut donner lieu à des chocs électriques, une dispersion électrique, de la fumée et/ou un incendie.
- Branchez le fil de terre. (Mise à la terre)
Toute mise à la terre incomplète provoque une électrocution.
- Ne raccordez pas les fils de terre à des conduites de gaz, des conduites d'eau, du parafoudre ou des fils de terre pour câbles téléphoniques.
- Après avoir terminé le travail de réparation ou de déplacement, assurez-vous que le fil de terre est correctement raccordé.
- Installez un coupe-circuit respectant les spécifications du manuel d'installation et les dispositions des réglementations et de la législation locales.
- Installez le coupe-circuit là où il peut facilement être accessible par l'agent.
- Lors de l'installation du coupe-circuit à l'extérieur, installez-en un qui soit conçu pour être utilisé à l'extérieur.
- Le câble d'alimentation ne doit en aucun cas présenter de rallonge. Des problèmes de raccordement dans des endroits où le câble présente une rallonge peuvent entraîner de la fumée et/ou un incendie.
- Le travail de câblage électrique doit être conduit conformément à la législation et à la réglementation locales et au manuel d'installation.
Dans le cas contraire, une électrocution ou un court-circuit peut survenir.

Essai de fonctionnement

- Avant de faire fonctionner le climatiseur après avoir terminé le travail, assurez-vous que le couvercle du boîtier des pièces électriques de l'unité intérieure et du panneau de service de l'unité extérieure sont fermés, ensuite, réglez le coupe-circuit sur la position ON. Vous pouvez recevoir un choc électrique si l'alimentation est activée sans avoir d'abord effectué ces vérifications.
- En cas de problème au niveau du climatiseur (comme par exemple en cas d'erreur, d'odeur de brûlé ou de sons anormaux, lorsque le climatiseur ne parvient pas à refroidir ou à réchauffer l'air ou en cas de fuite d'eau), ne touchez pas le climatiseur vous-même et réglez le disjoncteur sur la position OFF, puis contactez une personne d'entretien qualifiée. Prenez des mesures pour garantir que l'alimentation ne sera pas branchée (en indiquant "hors service" près du disjoncteur, par exemple) jusqu'à ce que la personne d'entretien qualifiée arrive. Continuer à utiliser le climatiseur alors qu'il présente un problème peut entraîner des problèmes mécaniques ou donner lieu à des chocs électriques et autres pannes.

- Une fois le travail terminé, utilisez un contrôleur d'isolement (mégohmmètre de 500 V) afin de vérifier que la résistance est de 1 MΩ minimum entre la section de charge et la section métallique sans charge (Section terre). Si la valeur de résistance est faible, une catastrophe telle qu'une fuite ou un choc électrique se produit sur le côté utilisateur.
- A l'issue du travail d'installation, vérifiez qu'il n'y a pas de fuites de fluide frigorigène et vérifiez la résistance d'isolation ainsi que l'évacuation d'eau. Ensuite, effectuez un essai de fonctionnement afin de vous assurer que le climatiseur fonctionne correctement.

Explications données à l'utilisateur

- A l'issue du travail d'installation, dites à l'utilisateur où se trouve le coupe-circuit. Si l'utilisateur ne sait pas où se trouve le coupe-circuit, il ou elle ne sera pas capable de le désactiver au cas où un problème surviendrait au niveau du climatiseur.
- Si la grille du ventilateur est endommagée, n'approchez pas de l'unité extérieure et réglez le disjoncteur sur la position OFF, ensuite contactez une personne d'entretien qualifiée(*1) pour effectuer les réparations. Ne réglez pas le disjoncteur en position ON jusqu'à ce que les réparations soient terminées.
- Après le travail d'installation, reportez-vous au Mode d'emploi pour expliquer au client comment utiliser l'unité et effectuer son entretien.

Réinstallation

- Seul un installateur qualifié(*1) ou une personne d'entretien qualifiée(*1) est autorisé à déplacer le climatiseur. Déplacer le climatiseur par une personne non-qualifiée représente un danger étant donné qu'un incendie, un choc électrique, des blessures, des fuites d'eau, des parasites et/ou des vibrations peuvent en résulter.
- Lors de la réalisation du travail de pompage, coupez le compresseur avant de débrancher le tuyau de réfrigérant. Débrancher le tuyau de réfrigérant alors que la vanne d'entretien est restée ouverte et que le compresseur fonctionne encore peut entraîner une aspiration de l'air ou d'autre gaz, faisant augmenter la pression à l'intérieur du circuit de réfrigération à un niveau anormalement élevé, et pouvant donner lieu à un éclatement, un dommage ou d'autres problèmes.

⚠ PRÉCAUTION

Installation du climatiseur utilisant le nouveau réfrigérant

- **CE CLIMATISEUR UTILISE LE NOUVEAU REFRIGERANT HFC (R410A) QUI NE DETRUIT PAS LA COUCHE D'OZONE.**
- Le réfrigérant R410A se distingue par son absorption aisée de l'eau, de la membrane oxydante ou de l'huile ainsi que par sa pression, qui est d'environ 1,6 fois celle du réfrigérant R22. Outre l'utilisation du nouveau réfrigérant, l'huile réfrigérante a elle aussi été remplacée. Ainsi, durant la procédure d'installation, aucune goutte d'eau, trace de poussière, de réfrigérant ayant servi précédemment ou d'huile de réfrigération ne doit entrer dans le cycle de réfrigération.
- Pour éviter de remplir du réfrigérant et de l'huile réfrigérante inappropriés, la taille des sections de raccordement de l'orifice de remplissage de l'unité principale et les outils d'installation sont différents de ceux qui sont utilisés pour le réfrigérant traditionnel.
- En conséquence, les outils exclusifs sont requis pour le nouveau réfrigérant (R410A).
- Quant aux tuyaux de raccordement, utilisez des tuyaux neufs et propres conçus pour le R410A et veillez à ce que l'eau ou la poussière n'y entrent pas.

Pour déconnecter l'appareil du secteur.

- Cet appareil doit être connecté au secteur via un interrupteur ayant une séparation de contact d'au moins 3 mm.
- Vous devez utiliser un fusible d'installation (tous les types de fusible peuvent être utilisés) pour la ligne d'alimentation de ce climatiseur.**

(*1) Reportez-vous à "Définition d'un Installateur qualifié ou Technicien d'entretien qualifié".

Vielen Dank, dass Sie sich für ein Klimagerät von Toshiba entschieden haben.

Bitte lesen Sie diese Anleitung, die wichtige Informationen gemäß der „Maschinenrichtlinie“ (Richtlinie 2006/42/EG) enthält, aufmerksam und klären Sie eventuelle Fragen.

Geben Sie nach Abschluss der Installation dieses Installationshandbuch und die Bedienungsanleitung dem Benutzer und bitten Sie ihn, diese zu Informationszwecken an einem sicheren Ort aufzubewahren.

Allgemeine Bezeichnung: Klimaanlage

Definition der Bezeichnungen „Qualifizierter Installateur“ oder „Qualifizierter Servicetechniker“

Die Klimaanlage muss von einem qualifizierten Installateur oder einem qualifizierten Servicetechniker installiert, gewartet, repariert und entsorgt werden. Wenn eine dieser Aufgaben erledigt werden muss, bitten Sie einen qualifizierten Installateur oder einen qualifizierten Servicetechniker, diese für Sie auszuführen.

Ein qualifizierter Installateur oder ein qualifizierter Servicetechniker ist ein Auftragnehmer, der über die Qualifikationen und das Fachwissen verfügt, welche in der untenstehenden Tabelle genannt sind.

Auftragnehmer	Qualifikationen und Fachwissen, über welche der Auftragnehmer verfügen muss
Qualifizierter Installateur	<ul style="list-style-type: none"> Der Installationsfachmann ist eine Person, die Klimageräte der Toshiba Carrier Corporation einbaut, wartet, umzieht und ausbaut. Die Person ist im Einbau und in der Wartung sowie im Umzug und Ausbau von Klimageräten der Toshiba Carrier Corporation geschult oder wurde von einer geschulten Person oder geschulten Personen unterwiesen und verfügt aufgrund dessen über gründliche Kenntnisse, die sie zur Ausführung dieser Arbeiten befähigen. Der Installationsfachmann, dem es erlaubt ist, Elektroarbeiten im Zuge des Einbaus, Umzugs oder Ausbaus auszuführen, verfügt über die jeweils gesetzlich vorgeschriebene Qualifikation zur Ausführung von Elektroarbeiten und ist eine Person, die im Zusammenhang mit Elektroarbeiten an Klimageräten der Toshiba Carrier Corporation geschult ist oder in diesem Zusammenhang von einer geschulten Person oder geschulten Personen unterwiesen wurde, so dass sie über gründliche Kenntnisse verfügt, die sie zur Ausführung dieser Arbeiten befähigen. Der Installationsfachmann, dem es erlaubt ist, kältemittel- oder rohrtechnische Arbeiten im Zuge des Einbaus, Umzugs oder Ausbaus auszuführen, verfügt über die jeweils gesetzlich vorgeschriebene Qualifikation zur Ausführung von kältemittel- und rohrtechnischen Arbeiten und ist eine Person, die im Zusammenhang mit kältemittel- und rohrtechnischen Arbeiten an Klimageräten der Toshiba Carrier Corporation geschult ist oder in diesem Zusammenhang von einer geschulten Person oder geschulten Personen unterwiesen wurde, so dass sie über gründliche Kenntnisse verfügt, die sie zur Ausführung dieser Arbeiten befähigen. Der Installationsfachmann, dem es erlaubt ist, Arbeiten in der Höhe auszuführen, ist im Zusammenhang mit Arbeiten in der Höhe an Klimageräten der Toshiba Carrier Corporation geschult oder wurde in diesem Zusammenhang von einer geschulten Person oder geschulten Personen unterwiesen und verfügt aufgrund dessen über gründliche Kenntnisse, die ihn zur Ausführung dieser Arbeiten befähigen.
Qualifizierter Servicetechniker	<ul style="list-style-type: none"> Der Kundendienstfachmann ist eine Person, die Klimageräte der Toshiba Carrier Corporation einbaut, repariert, wartet, umzieht und ausbaut. Die Person ist im Einbau, in der Reparatur und in der Wartung sowie im Umzug und Ausbau von Klimageräten der Toshiba Carrier Corporation geschult oder wurde von einer geschulten Person oder geschulten Personen unterwiesen und verfügt aufgrund dessen über gründliche Kenntnisse, die sie zur Ausführung dieser Arbeiten befähigen. Der Kundendienstfachmann, dem es erlaubt ist, Elektroarbeiten im Zuge des Einbaus, der Reparatur, des Umzugs oder Ausbaus auszuführen, verfügt über die jeweils gesetzlich vorgeschriebene Qualifikation zur Ausführung von Elektroarbeiten und ist eine Person, die im Zusammenhang mit Elektroarbeiten an Klimageräten der Toshiba Carrier Corporation geschult ist oder in diesem Zusammenhang von einer geschulten Person oder geschulten Personen unterwiesen wurde, so dass sie über gründliche Kenntnisse verfügt, die sie zur Ausführung dieser Arbeiten befähigen. Der Kundendienstfachmann, dem es erlaubt ist, kältemittel- oder rohrtechnische Arbeiten im Zuge des Einbaus, der Reparatur, des Umzugs oder Ausbaus auszuführen, verfügt über die jeweils gesetzlich vorgeschriebene Qualifikation zur Ausführung von kältemittel- und rohrtechnischen Arbeiten und ist eine Person, die im Zusammenhang mit kältemittel- und rohrtechnischen Arbeiten an Klimageräten der Toshiba Carrier Corporation geschult ist oder in diesem Zusammenhang von einer geschulten Person oder geschulten Personen unterwiesen wurde, so dass sie über gründliche Kenntnisse verfügt, die sie zur Ausführung dieser Arbeiten befähigen. Der Kundendienstfachmann, dem es erlaubt ist, Arbeiten in der Höhe auszuführen, ist im Zusammenhang mit Arbeiten in der Höhe an Klimageräten der Toshiba Carrier Corporation geschult oder wurde in diesem Zusammenhang von einer geschulten Person oder geschulten Personen unterwiesen und verfügt aufgrund dessen über gründliche Kenntnisse, die ihn zur Ausführung dieser Arbeiten befähigen.

Definitionen zur Schutzkleidung





Bei Transport, Einbau, Wartung, Reparatur und Ausbau des Klimageräts sind Schutzhandschuhe und Sicherheitsarbeitskleidung zu tragen.

Neben dieser normalen Schutzausrüstung wird für die in der Tabelle unten aufgeführten Spezialarbeiten die jeweils genannte Schutzausrüstung benötigt.

Wer auf Schutzausrüstung verzichtet, geht ein hohes Risiko ein, denn die Ausrüstung schützt vor Verletzungen, Verbrennungen, Stromschlag und anderen Gefahren.

Arbeitsaufgabe	Zu tragende Schutzkleidung
Alle Arten von Arbeiten	Schutzhandschuhe Sicherheitsarbeitskleidung
Elektroarbeiten	Isolierhandschuhe zum Schutz vor Stromschlägen und hohen Temperaturen Isolierschuhe Arbeitskleidung, die Schutz vor Elektroschock bietet
Arbeiten in der Höhe (50 cm und höher)	Industrie-Schutzhelme
Transport schwerer Gegenstände	Schuhe mit Zehenschutzkappen
Reparatur des Außengeräts	Isolierhandschuhe zum Schutz vor Stromschlägen und hohen Temperaturen

■ Warnhinweise am Klimagerät

Warnanzeige	Beschreibung		
 <table border="1"> <tr> <td>WARNING</td> </tr> <tr> <td>ELECTRICAL SHOCK HAZARD Disconnect all remote electric power supplies before servicing.</td> </tr> </table>	WARNING	ELECTRICAL SHOCK HAZARD Disconnect all remote electric power supplies before servicing.	WARNUNG GEFAHR EINES ELEKTRISCHEN SCHLAGS Trennen Sie alle fernen Stromversorgungsquellen vom Netz, bevor Sie Wartungsarbeiten ausführen.
WARNING			
ELECTRICAL SHOCK HAZARD Disconnect all remote electric power supplies before servicing.			
 <table border="1"> <tr> <td>WARNING</td> </tr> <tr> <td>Moving parts. Do not operate unit with grille removed. Stop the unit before the servicing.</td> </tr> </table>	WARNING	Moving parts. Do not operate unit with grille removed. Stop the unit before the servicing.	WARNUNG Bewegliche Teile. Bedienen Sie nicht das Gerät, wenn das Gitter entfernt wurde. Stoppen Sie das Gerät, bevor Sie es warten.
WARNING			
Moving parts. Do not operate unit with grille removed. Stop the unit before the servicing.			
 <table border="1"> <tr> <td>CAUTION</td> </tr> <tr> <td>High temperature parts. You might get burned when removing this panel.</td> </tr> </table>	CAUTION	High temperature parts. You might get burned when removing this panel.	VORSICHT Teile mit hohen Temperaturen. Es besteht die Gefahr, dass Sie sich verbrennen, wenn Sie diese Abdeckung entfernen.
CAUTION			
High temperature parts. You might get burned when removing this panel.			
 <table border="1"> <tr> <td>CAUTION</td> </tr> <tr> <td>Do not touch the aluminum fins of the unit. Doing so may result in injury.</td> </tr> </table>	CAUTION	Do not touch the aluminum fins of the unit. Doing so may result in injury.	VORSICHT Die Aluminiumlamellen des Geräts nicht berühren. Dies kann zu Verletzungen führen.
CAUTION			
Do not touch the aluminum fins of the unit. Doing so may result in injury.			
 <table border="1"> <tr> <td>CAUTION</td> </tr> <tr> <td>BURST HAZARD Open the service valves before the operation, otherwise there might be the burst.</td> </tr> </table>	CAUTION	BURST HAZARD Open the service valves before the operation, otherwise there might be the burst.	VORSICHT EXPLOSIONSGEFAHR! Öffnen Sie vor dem Arbeitsgang die Versorgungsventile, da es anderenfalls zu einer Explosion kommen kann.
CAUTION			
BURST HAZARD Open the service valves before the operation, otherwise there might be the burst.			

1 Vorsichtsmaßnahmen für die Sicherheit

Der Hersteller übernimmt keinerlei Haftung für durch Nichtbeachtung der Beschreibungen in diesem Handbuch entstandene Schäden.

WARNUNG

Allgemeines

- Bevor Sie mit der Installation des Klimageräts beginnen, lesen Sie das Installationshandbuch sorgfältig durch und befolgen Sie die darin enthaltenen Anweisungen zum Installieren des Klimageräts.
- Die Installationsarbeiten dürfen nur von qualifiziertem Installations- oder Servicepersonal durchgeführt werden. Durch eine nicht fachgerechte Installation kann es zu Wasserschäden, Stromschlägen oder sogar zu Bränden kommen.
- Verwenden Sie ausschließlich das zur Ergänzung oder als Ersatz angegebene Kühlmittel. Andernfalls kann im Kühlkreislauf ein abnormal hoher Druck entstehen, der eine Fehlfunktion oder Explosion des Produkts oder Verletzungen zur Folge haben kann.
- Bevor Sie das Einlassgitter des Innengeräts oder das Wartungspaneel des Außengeräts öffnen, stellen Sie den Schutzschalter auf die Position OFF (aus). Sollten Sie diesen Hinweis nicht beachten, kann es durch Kontakt mit den Innenteilen zu einem Stromschlag kommen. Nur ein qualifizierter Installateur(*1) oder ein qualifizierter Servicetechniker(*1) darf das Einlassgitter des Innengeräts oder das Wartungspaneel des Außengeräts entfernen und die erforderlichen Arbeiten ausführen.
- Bevor Sie mit den Installations-, Wartungs-, Reparatur- oder Deinstallationsarbeiten beginnen, schalten Sie den Hauptschalter in die Stellung OFF (aus). Andernfalls kann es zu elektrischen Schlägen kommen.
- Befestigen Sie ein Schild „Arbeiten in Ausführung“ neben dem Schutzschalter, während die Installations-, Wartungs-, Reparatur- oder Entsorgungsarbeiten ausgeführt werden. Es besteht die Gefahr von Stromschlägen, wenn der Schutzschalter aus Versehen auf ON (ein) gestellt wird.
- Nur ein qualifizierter Installateur(*1) oder ein qualifizierter Servicetechniker(*1) darf Höhenarbeiten unter Verwendung eines 50 cm hohen oder noch höheren Ständers ausführen oder das Einlassgitter des Innengeräts entfernen und die erforderlichen Arbeiten ausführen.
- Tragen Sie bei Installation, Wartung und Entsorgung Schutzhandschuhe und Arbeitsschutzbekleidung.
- Die Aluminiumlamelle des Geräts nicht berühren. Andernfalls können Sie sich verletzen. Wenn die Rippen aus einem bestimmten Grund berührt werden muss, ziehen Sie zuerst Schutzhandschuhe und Arbeitsschutzbekleidung an, bevor Sie diese Arbeiten ausführen.
- Klettern Sie nicht auf das Außengerät, und stellen Sie keine Gegenstände darauf ab. Andernfalls können Sie abstürzen, oder Gegenstände können herunterfallen. In beiden Fällen besteht Verletzungsgefahr.
- Wenn Sie Höhenarbeiten ausführen, verwenden Sie eine Leiter gemäß ISO-Norm 14122 und befolgen Sie die in der Anleitung der Leiter aufgeführten Anweisungen. Tragen Sie als Schutzkleidung beim Ausführen der Arbeiten außerdem einen Industrie-Schutzhelm.
- Bevor Sie den Filter oder andere Teile des Außengeräts reinigen, stellen Sie unbedingt den Schutzschalter auf OFF (aus), und befestigen Sie ein Schild „Laufende Arbeiten“ neben dem Schutzschalter, bevor Sie die Arbeiten ausführen.
- Bevor Sie Höhenarbeiten ausführen, stellen Sie ein Warnschild auf, damit sich niemand dem Arbeitsbereich nähert. Teile und andere Gegenstände können von oben herunterfallen und u. U. unten befindliche Personen verletzen. Tragen Sie während der Arbeit einen Helm zum Schutz vor herabfallenden Objekten.
- Diese Klimaanlage verwendet das Kühlmittel R410A.
- Die Klimaanlage muss in einem stabilen Zustand transportiert werden. Setzen Sie sich mit Ihrem Fachhändler in Verbindung, falls Sie feststellen sollten, dass ein Teil des Produkts defekt ist.
- Falls die Klimaanlage von Hand transportiert wird, muss von mindestens zwei Personen getragen werden.
- Versuchen Sie unter keinen Umständen, eines der Geräte selbst auszubauen bzw. instand zu setzen. Im Geräteinneren liegt Hochspannung an. Beim Ausbau von Abdeckung und Hauptgerät besteht elektrische Berührungsgefahr.

Auswahl des Installationsortes

- Wenn Sie die Klimaanlage in einem kleinen Raum installieren, treffen Sie entsprechende Vorkehrungen, damit es in dem Raum bei einem Leck nicht zu einer übermäßigen Konzentration von Kühlmitteldämpfen kommt.
- Nehmen Sie keine Installation an einem Ort vor, an dem der Austritt entflammbarer Gase möglich sein könnte. Wenn entflammbares Gas austritt und sich um das Gerät herum ansammelt, könnte es sich entzünden und einen Brand verursachen.
- Tragen Sie beim Transportieren der Klimaanlage Schuhe mit Zehenschutzkappen.
- Halten Sie die Klimaanlage beim Tragen nicht an den Bändern des Verpackungskartons fest. Andernfalls können Sie sich verletzen, wenn die Bänder reißen.
- Installieren Sie das Innengerät mindestens 2,5 m über dem Boden, da sich Personen anderenfalls verletzen oder Stromschläge erleiden können, falls sie ihre Finger oder andere Gegenstände in das Innengerät stecken, während die Klimaanlage läuft.
- Stellen Sie keine Verbrennungsvorrichtung an Orten auf, wo sie direkt dem Wind der Klimaanlage ausgesetzt ist, da anderenfalls eine unvollständige Verbrennung die Folge ist.

Installation

- Wenn das Innengerät aufgehängt werden soll, müssen die angegebenen Hängeschrauben (M10 oder W3/8) und Muttern (M10 oder W3/8) verwendet werden.
- Installieren Sie die Klimaanlage sicher an einer Stelle, die für das Gewicht des Geräts geeignet ist. Ist der Boden nicht widerstandsfähig genug, kann das Gerät umkippen und Verletzungen verursachen.

- Installieren Sie die Klimaanlage entsprechend den Anweisungen im Installationshandbuch. Bei Missachtung dieser Anweisungen kann das Gerät hinunterfallen, umkippen oder Geräusche, Vibrationen, Wasseraustritte oder andere Probleme verursachen.
- Falls Sie in einem windanfälligen oder erdbebengefährdeten Gebiet leben, achten Sie bei der Installation auf eine entsprechende Auslegung der Befestigung. Wenn die Klimaanlage nicht ordnungsgemäß installiert wird, kann das Gerät umkippen oder hinunterfallen und so einen Unfall verursachen.
- Ist während der Installation Kühlmittel ausgetreten, lüften Sie den Raum umgehend. Kommen Kühlmitteldämpfe in Kontakt mit Feuer, können sich gesundheitsschädliche Gase bilden.
- Verwenden Sie für den Transport der Klimaanlage einen Gabelstapler sowie eine Winde oder einen Flaschenzug bei der Installation.

Kühlmittelleitungen

- Überprüfen Sie die sichere Installation der Kühlmittelleitung, bevor Sie das Klimagerät in Betrieb nehmen. Falls der Kompressor bei geöffnetem Ventil und ohne Kühlmittelrohr betrieben wird, saugt er Luft ein, und der Gasdruck im Kühlkreislauf wird extrem hoch, was zu Verletzungen führen kann.
- Ziehen Sie die Bördelmutter mit einem Drehmomentschlüssel wie angegeben fest. Übermäßiges Festziehen der Bördelmutter kann nach längerer Zeit zu Rissen in der Bördelmutter führen, wodurch Kühlmittel auslaufen kann.
- Vergewissern Sie sich daher nach der Installation noch einmal, dass kein Kühlmittel austreten kann. Wenn Kühlmittelgase austreten und in einen Raum mit einem Herd oder Ofen gelangen, kann es bei einer offenen Flamme zur Bildung von gesundheitsschädlichen Gasen kommen.
- Wenn die Klimaanlage installiert oder umgesetzt wurde, führen Sie gemäß den Anweisungen im Installationshandbuch eine vollständige Luftspülung aus, so dass lediglich das Kühlmittel im Kühlkreislauf gemischt wird. Wird keine vollständige Luftspülung ausgeführt, können Fehlfunktionen der Klimaanlage auftreten.
- Für die Luftdichtprüfung muss Stickstoff verwendet werden.
- Der Zuleitungsschlauch muss so angeschlossen werden, dass er nicht durchhängt.

Elektrische Verdrahtung

- Nur ein qualifizierter Installateur(*1) oder ein qualifizierter Servicetechniker(*1) darf Elektroarbeiten an der Klimaanlage ausführen. Unter keinen Umständen dürfen diese Arbeiten von unqualifizierten Mitarbeitern ausgeführt werden, da eine nicht sachgemäße Ausführung der Arbeit zu elektrischen Schlägen und/oder Kriechströmen führen kann.
- Tragen Sie beim Anschließen von elektrischen Drähten, Reparieren von elektrischen Teilen oder Ausführen anderer Elektroarbeiten Isolierhandschuhe zum Schutz vor Stromschlägen und hohen Temperaturen, isolierendes Schuhwerk sowie Arbeitsschutzkleidung zum Schutz vor Stromschlägen. Falls keine Schutzkleidung getragen wird, kann es zu elektrischen Schlägen kommen.
- Beachten Sie beim Legen von elektrischen Leitungen die Spezifikationen im Installationshandbuch sowie die Bestimmungen der lokalen Gesetze und die Rechtsvorschriften. Bei Verwendung von Kabeln, die die Spezifikationen nicht erfüllen, kann es zu Stromschlägen, Kriechströmen, Rauchentwicklungen und/oder Bränden kommen.
- Schließen Sie das Erdungskabel an. (Erdungsarbeiten)
Ohne vorschriftsmäßige Erdung besteht Stromschlaggefahr.
- Schließen Sie die Erdungskabel nie an Gas- oder Wasserleitungen, Blitzableiter oder Erdungskabel von Telefonkabeln an.
- Prüfen Sie nach Abschluss der Reparatur- oder Umsetzungsarbeiten, ob die Erdungsleiter korrekt angeschlossen sind.
- Installieren Sie einen Schutzschalter, der die Spezifikationen im Installationshandbuch sowie die Bestimmungen der lokalen Gesetze und die Rechtsvorschriften erfüllt.
- Bringen Sie den Schutzschalter an einem Ort an, wo er vom Bediener problemlos erreicht werden kann.
- Wenn der Schutzschalter im Freien installiert werden soll, verwenden Sie einen Outdoor-Schutzschalter.
- Das Stromkabel darf unter keinen Umständen durch ein Verlängerungskabel erweitert werden. Bei Anschlussproblemen des Kabels an den Verlängerungsstellen kann es zu Rauchentwicklungen und/oder Bränden kommen.
- Alle elektrischen Arbeiten sind nach geltender Vorschrift und unter Beachtung der Installationsanleitung auszuführen. Es besteht Stromschlag- und Kurzschlussgefahr.

Testlauf

- Bevor Sie die Klimaanlage nach Abschluss der Arbeiten betreiben, stellen Sie sicher, dass die Abdeckung des Elektrokastens am Innengerät und das Wartungspaneel des Außengeräts geschlossen sind, und stellen Sie den Schutzschalter auf die Position ON (ein). Sie können einen elektrischen Schlag erleiden, falls der Strom eingeschaltet wird, ohne dass Sie vorher diese Prüfungen durchgeführt haben.
- Falls Probleme mit der Klimaanlage auftreten (z. B. ein Fehler wird angezeigt, es riecht verbrannt, ungewöhnliche Geräusche sind zu hören, die Klimaanlage kühlt bzw. heizt nicht oder Wasser läuft aus), suchen Sie nicht selbst nach der Ursache, sondern stellen Sie den Schutzschalter auf die Position OFF (aus) und wenden Sie sich an einen Servicetechniker. Stellen Sie sicher, dass der Strom nicht wieder eingeschaltet wird (indem Sie beispielsweise den Schutzschalter durch „außer Betrieb“ kennzeichnen), bis ein qualifizierter Servicetechniker eintrifft. Die weitere Verwendung der Klimaanlage in fehlerhaftem Zustand kann zur Verschlimmerung der mechanischen Probleme oder zu elektrischen Schlägen und anderen Problemen führen.
- Prüfen Sie nach Beendigung der Arbeiten mit einem Isolationsmessgerät (500-V-Megger), ob der Isolationswiderstand zwischen spannungsführenden Leitern und spannungsfreien Metallteilen (Erdpotenzial) 1 M Ω oder mehr beträgt. Falls der Widerstandswert zu niedrig ist, können an der Benutzerseite Kriechströme oder Stromschläge verursacht werden.
- Stellen Sie nach Abschluss der Installationsarbeiten sicher, dass kein Kühlmittel ausläuft, und prüfen Sie Isolierwiderstand sowie Wasserableitung. Führen Sie danach einen Testlauf durch, um sicherzustellen, dass die Klimaanlage ordnungsgemäß funktioniert.

Dem Benutzer mitzuteilende Informationen

- Teilen Sie dem Benutzer nach Abschluss der Installationsarbeiten mit, wo sich der Schutzschalter befindet. Sollte der Benutzer nicht wissen, wo sich der Schutzschalter befindet, kann er diesen nicht ausschalten, falls Probleme mit der Klimaanlage auftreten.
- Wenn das Ventilatorgitter beschädigt ist, fassen Sie das Außengerät nicht an, sondern schalten Sie den Schutzschalter auf die Position OFF (aus) und rufen Sie einen Kundendienstfachmann(*1), um die Reparatur durchzuführen. Stellen Sie den Schutzschalter erst wieder auf die Position ON (ein), nachdem die Reparaturen abgeschlossen wurden.
- Nach Abschluss der Installationsarbeiten erläutern Sie dem Kunden die Verwendung und Wartung des Geräts entsprechend dem Benutzerhandbuch.

Umsetzung

- Nur ein qualifizierter Installateur(*1) oder ein qualifizierter Servicetechniker(*1) darf die Klimaanlage umsetzen. Es ist gefährlich, wenn die Klimaanlage durch einen nicht qualifizierten Benutzer umgesetzt wird, da es zu Bränden, elektrischen Schlägen, Verletzungen, Wasseraustritten, Geräuschen und/oder Vibrationen kommen kann.
- Schließen Sie beim Durchführen der Abpumparbeiten zuerst den Kompressor, bevor Sie das Kühlmittelrohr trennen. Wenn die Kältemittelleitung bei offenem Wartungsventil abgetrennt wird und der Kompressor noch läuft, werden Luft oder andere Gase angesaugt. Der Druck im Kältemittelkreislauf steigt, und es besteht die Gefahr eines Leitungsbruchs und dementsprechend die Gefahr von Verletzungen und anderen Störungen.

VORSICHT

Installation von Klimageräten mit modernen Kühlmitteln

• DIESES KLIMAGERÄT ARBEITET MIT DEM NEUEN HFC KÄLTEMITTEL (R410A) WELCHES DIE OZONSCHICHT NICHT ANGREIFT.

- R410A-Kühlmittel absorbiert Wasser sehr schnell, kann Membrane oxidieren und ist empfindlich gegen Öl. Der Druck von R410A liegt etwa 1,6-mal höher als der von R22-Kühlmittel. Gleichzeitig mit dem Einsatz des neuen Kühlmittels wurde auch das bisher verwendete Kühlmaschinenöl gewechselt. Verhindern Sie deshalb, dass bei Installationsarbeiten Wasser, Staub, altes Kühlmittel oder Kühlmaschinenöl in den Kühlkreislauf gelangen.
- Um zu verhindern, dass falsches Kühlmittel und Kühlmaschinenöl eingefüllt wird, wurde, verglichen mit Systemen, die mit konventionellen Kühlmitteln arbeiten, die Größe der Anschlüsse zur Befüllung der Haupteinheit geändert und komplett neue Installationswerkzeuge konzipiert.
- Daher sind für das neue Kühlmittel (R410A) die entsprechenden Spezialwerkzeuge erforderlich.
- Verwenden Sie für die Anschlussleitungen ausschließlich neue, saubere Rohre, die eigens für R410A gefertigt wurden, und achten Sie darauf, dass kein Wasser oder Staub eindringt.

Trennen des Gerätes von der Hauptstromversorgung.

- Das Gerät muss an die Hauptstromversorgung über einen Schalter angeschlossen werden, dessen Kontakte einen Schaltabstand von mind. 3 mm aufweisen.

Die Installationssicherung muss für die Stromversorgungsleitung dieser Klimaanlage verwendet werden (hierfür können alle Typen verwendet werden).

(*1) Siehe „Definition der Bezeichnungen „Qualifizierter Installateur“ oder „Qualifizierter Servicetechniker““.

Grazie per aver acquistato questo Toshiba condizionatore d'aria.

Si prega di leggere attentamente queste istruzioni perché contengono informazioni importanti sulla conformità alla direttiva "Macchinari" (Direttiva 2006/42/CE).

Al completamento dell'installazione, consegnare all'utente il presente Manuale d'installazione e il Manuale d'uso forniti con l'unità esterna e chiedere all'utente di conservarli in un luogo sicuro per eventuali consultazioni future.

Denominazione generica: Condizionatore d'aria

Definizione di installatore qualificato o tecnico dell'assistenza qualificato

Il condizionatore d'aria deve essere installato, sottoposto a manutenzione, riparato e rimosso da un installatore qualificato o da un tecnico dell'assistenza qualificato. Quando deve essere eseguito uno di questi lavori, rivolgersi a un installatore qualificato o a un tecnico dell'assistenza qualificato per svolgerli in propria vece.

Un installatore qualificato o un tecnico dell'assistenza qualificato è un agente che dispone delle qualifiche e dell'esperienza descritti nella tabella seguente.

Agente	Qualifiche ed esperienza di cui deve disporre l'agente
Installatore qualificato	<ul style="list-style-type: none"> L'installatore qualificato è una persona che installa, effettua la manutenzione, sposta e rimuove i condizionatori d'aria costruiti da Toshiba Carrier Corporation. Ha ricevuto la formazione necessaria per installare, mantenere, spostare e rimuovere i condizionatori d'aria costruiti da Toshiba Carrier Corporation o, in alternativa, è stato addestrato da uno o più individui in possesso della necessaria formazione, ed è pertanto idoneo a svolgere tali operazioni. L'installatore qualificato autorizzato a eseguire i lavori elettrici richiesti per l'installazione, il trasferimento e la rimozione del condizionatore d'aria possiede le qualifiche necessarie per svolgere tali compiti, come stabilito dalle leggi e dai regolamenti locali; è stato addestrato a lavorare sui condizionatori d'aria direttamente da Toshiba Carrier Corporation o da uno o più individui in possesso della necessaria formazione ed è pertanto idoneo a svolgere tale lavoro. L'installatore qualificato autorizzato a eseguire i lavori di gestione del refrigerante e di posa dei tubi richiesti per l'installazione, il trasferimento e la rimozione del condizionatore d'aria possiede le qualifiche necessarie per svolgere tali compiti, come stabilito dalle leggi e dai regolamenti locali; è stato addestrato a lavorare a svolgere i lavori di gestione del refrigerante e di posa dei tubi direttamente da Toshiba Carrier Corporation o da uno o più individui in possesso della necessaria formazione ed è pertanto idoneo a svolgere tale lavoro. L'installatore qualificato autorizzato a svolgere lavori in altezza ha ricevuto la formazione necessaria per effettuare tali lavori con i condizionatori d'aria costruiti da Toshiba Carrier Corporation o, in alternativa, è stato addestrato da uno o più individui in possesso della necessaria formazione, ed è pertanto idoneo a svolgere tali operazioni.
Tecnico dell'assistenza qualificato	<ul style="list-style-type: none"> Il personale di assistenza qualificato è una persona che installa, ripara, effettua la manutenzione, sposta e rimuove i condizionatori d'aria costruiti da Toshiba Carrier Corporation. Ha ricevuto la formazione necessaria per installare, riparare, mantenere, spostare e rimuovere i condizionatori d'aria costruiti da Toshiba Carrier Corporation o, in alternativa, è stato addestrato da uno o più individui in possesso della necessaria formazione, ed è pertanto idoneo a svolgere tali operazioni. Il personale di assistenza qualificato autorizzato a eseguire i lavori elettrici richiesti per l'installazione, il trasferimento e la rimozione del condizionatore d'aria possiede le qualifiche necessarie per svolgere tali compiti, come stabilito dalle leggi e dai regolamenti locali; è stato addestrato a lavorare sui condizionatori d'aria direttamente da Toshiba Carrier Corporation o da uno o più individui in possesso della necessaria formazione ed è pertanto idoneo a svolgere tale lavoro. Il personale di assistenza qualificato autorizzato a eseguire i lavori di gestione del refrigerante e di posa dei tubi richiesti per l'installazione, la riparazione, il trasferimento e la rimozione del condizionatore d'aria possiede le qualifiche necessarie per svolgere tali compiti, come stabilito dalle leggi e dai regolamenti locali; è stato addestrato a lavorare a svolgere i lavori di gestione del refrigerante e di posa dei tubi direttamente da Toshiba Carrier Corporation o da uno o più individui in possesso della necessaria formazione ed è pertanto idoneo a svolgere tale lavoro. Il personale di assistenza qualificato autorizzato a svolgere lavori in altezza ha ricevuto la formazione necessaria per effettuare tali lavori con i condizionatori d'aria costruiti da Toshiba Carrier Corporation o, in alternativa, è stato addestrato da uno o più individui in possesso della necessaria formazione, ed è pertanto idoneo a svolgere tali operazioni.

Definizione di attrezzatura protettiva





Prima di procedere alle operazioni di trasporto, installazione, manutenzione, riparazione o rimozione del condizionatore d'aria è necessario indossare sempre guanti e abbigliamento protettivi.

In aggiunta ai normali dispositivi di protezione, indossare i dispositivi di protezione descritti di seguito, prima di procedere all'esecuzione dei lavori speciali elencati nella tabella sottostante.

La mancata osservanza di questa indicazione espone l'operatore al rischio di lesioni, ustioni, elettrocuzione, ecc.

Lavoro intrapreso	Attrezzatura protettiva indossata
Tutti i tipi di lavori	Guanti protettivi Abbigliamento protettivo da lavoro
Lavoro su impianti elettrici	Guanti di protezione per elettricisti e resistenti al calore Scarpe isolanti Abbigliamento per la protezione da elettrocuzione
Lavori in altezza (50 cm o più)	Elmetti per uso industriale
Trasporto di oggetti pesanti	Scarpe con calotte protettive aggiuntive per le dita
Riparazione dell'unità esterna	Guanti di protezione per elettricisti e resistenti al calore

■ Indicazioni di avvertimento sul condizionatore d'aria

Indicazione di avvertimento		Descrizione
	WARNING ELECTRICAL SHOCK HAZARD Disconnect all remote electric power supplies before servicing.	AVVERTENZA PERICOLO DI SCOSSA ELETTRICA Scollegare tutte le fonti di alimentazione elettrica remota, prima di sottoporre a interventi di assistenza.
	WARNING Moving parts. Do not operate unit with grille removed. Stop the unit before the servicing.	AVVERTENZA Parti mobili. Non far funzionare l'unità con la griglia rimossa. Arrestare l'unità prima di sottoporla ad assistenza.
	CAUTION High temperature parts. You might get burned when removing this panel.	ATTENZIONE Parti ad alta temperatura. Quando si rimuove questo pannello sussiste il pericolo di ustione.
	CAUTION Do not touch the aluminum fins of the unit. Doing so may result in injury.	ATTENZIONE Non toccare le alette in alluminio dell'unità. In caso contrario, si potrebbero provocare lesioni personali.
	CAUTION BURST HAZARD Open the service valves before the operation, otherwise there might be the burst.	ATTENZIONE PERICOLO DI SCOPPIO Aprire le valvole di servizio prima dell'operazione; in caso contrario, si potrebbe verificare uno scoppio.

1 Precauzioni per la sicurezza

Il produttore non si assume alcuna responsabilità per i danni causati dalla mancata osservazione delle descrizioni del presente manuale.

AVVERTENZA

Generali

- Prima d'iniziare l'installazione del condizionatore d'aria si raccomanda di leggere con attenzione il manuale d'installazione e di osservarne scrupolosamente ogni istruzione ivi fornita.
- Solo un installatore qualificato o un tecnico dell'assistenza qualificato sono autorizzati a installare l'unità. Se l'installazione non è stata eseguita correttamente si possono infatti verificare perdite d'acqua, scosse elettriche o un incendio.
- Per rabbocchi o sostituzioni, non utilizzare refrigeranti diversi da quello indicato. In caso contrario nel ciclo di refrigerazione si può generare una pressione eccessiva, che può generare guasti, esplosione del prodotto o pericolo per le persone.
- Prima di aprire la griglia della presa d'aria dell'unità interna o il pannello di servizio dell'unità esterna, impostare l'interruttore automatico sulla posizione OFF (spento). La mancata impostazione dell'interruttore automatico sulla posizione OFF (spento) potrebbe provocare scosse elettriche attraverso il contatto con le parti interne. Solo un installatore qualificato(*1) o un tecnico dell'assistenza qualificato(*1) sono autorizzati a rimuovere la griglia della presa d'aria dell'unità interna o il pannello di servizio dell'unità esterna e a svolgere il lavoro richiesto.
- Prima di effettuare i lavori di installazione, manutenzione, riparazione o rimozione, impostare l'interruttore automatico sulla posizione OFF (spento). In caso contrario, si potrebbero causare scosse elettriche.
- Sistemare un cartello con l'indicazione "Lavori in corso" in prossimità dell'interruttore automatico durante l'esecuzione di lavori di installazione, manutenzione, riparazione o rimozione. Qualora l'interruttore automatico sia impostato su ON (acceso) per errore, sussiste il pericolo di scosse elettriche.
- Solo un installatore qualificato(*1) o un tecnico dell'assistenza qualificato(*1) sono autorizzati a svolgere lavori in altezza utilizzando un supporto di altezza pari o superiore a 50 cm per rimuovere la griglia della presa d'aria dell'unità interna al fine dello svolgimento dei lavori.
- Durante l'installazione, la manutenzione e la rimozione, indossare guanti di protezione e indumenti da lavoro di sicurezza.
- Non toccare l'aletta in alluminio dell'unità. In caso contrario, si potrebbero provocare lesioni personali. Qualora sia necessario toccare l'aletta per qualche motivo, indossare prima guanti di protezione e indumenti da lavoro di sicurezza, quindi procedere.
- Non salire né collocare oggetti sull'unità esterna. Si potrebbe cadere o gli oggetti potrebbero cadere dall'unità esterna e provocare lesioni personali.
- Quando si lavora in altezza, utilizzare una scala conforme allo standard ISO 14122, e attenersi alla procedura indicata nelle istruzioni della scala. Inoltre, indossare un elmetto per uso industriale come attrezzatura di protezione per intraprendere il lavoro.
- Prima di pulire il filtro o altre parti dell'unità esterna, accertarsi di aver impostato l'interruttore sulla posizione OFF (spento) e sistemare un cartello con l'indicazione "Lavori in corso" in prossimità dell'interruttore, prima di iniziare il lavoro.
- Prima di lavorare in altezza, sistemare un cartello in modo che nessuno si avvicini alla sede dei lavori, prima di procedere con i lavori. Parti e altri oggetti potrebbero cadere dall'alto, con la possibilità di provocare lesioni personali a chi si trovi sotto. Mentre si effettuano i lavori, indossare un casco per proteggersi dalla caduta di oggetti.
- Il refrigerante utilizzato da questo condizionatore d'aria è l'R410A.
- Il condizionatore d'aria deve essere trasportato in condizioni stabili. Qualora una parte qualsiasi non sia integra si raccomanda di rivolgersi immediatamente al rivenditore.
- Se il condizionatore d'aria deve essere trasportato manualmente, l'operazione deve essere effettuata da due o più persone.
- Non tentare di spostare o riparare l'unità da soli. L'unità contiene componenti ad alta tensione. La rimozione del coperchio e dell'unità centrale potrebbe esporre al rischio di elettrocuzione.

Selezione della sede di installazione

- Se il condizionatore d'aria deve essere installato in un locale piccolo è necessario evitare che in caso di perdite il refrigerante raggiunga una concentrazione critica.
- Non installare in un luogo soggetto a possibili fughe di gas infiammabili. Qualora dovessero raggiungere una concentrazione elevata attorno ad esse potrebbero infatti causare un incendio.
- Per trasportare il condizionatore d'aria, indossare scarpe con calotte protettive aggiuntive per le dita.
- Per trasportare il condizionatore d'aria, non afferrare le fascette che circondano la scatola di imballaggio. Qualora le fascette si rompano, si potrebbero subire lesioni personali.
- Installare l'unità interna ad almeno 2,5 metri di altezza dal pavimento, poiché, in caso contrario, gli utenti potrebbero subire lesioni personali o scosse elettriche qualora urtino con le dita o altri oggetti l'unità interna mentre il condizionatore d'aria è in funzione.
- Non collocare apparecchi a combustione di alcun genere in luoghi che siano direttamente esposti al flusso d'aria prodotto dal condizionatore d'aria; in caso contrario, il condizionatore potrebbe provocare una combustione imperfetta.

Installazione

- Quando si deve montare in sospensione l'unità interna, è necessario utilizzare i bulloni di sospensione (M10 o W3/8) e i relativi dadi (M10 o W3/8) specificati.
- Il condizionatore deve essere installato in un punto in grado di sostenerne adeguatamente il peso. Qualora la resistenza non sia sufficiente, l'unità potrebbe cadere e provocare lesioni personali.
- Attenersi alle istruzioni nel Manuale d'installazione per installare il condizionatore d'aria. La mancata osservanza di queste istruzioni potrebbe infatti causare la caduta o il ribaltamento delle unità, nonché divenire causa di rumore, vibrazioni, fuoriuscite d'acqua o altri problemi.
- Effettuare l'installazione considerando l'eventuale possibilità di vento forte o di terremoti. Se il condizionatore d'aria non è installato correttamente, un'unità può ribaltarsi o cadere, causando un incidente.
- Se durante l'installazione si verifica una fuga del gas refrigerante occorre ventilare subito l'ambiente. A contatto con fiamme libere il gas refrigerante s'incendia generando sostanze nocive.
- Utilizzare un carrello elevatore per trasportare le unità del condizionatore d'aria e per la loro installazione utilizzare un argano o un paranco.

Tubi del liquido refrigerante

- Installare il tubo del refrigerante stabilmente durante i lavori di installazione, prima di mettere in funzione il condizionatore d'aria. Se il compressore venisse messo in funzione con la valvola aperta e senza il tubo del refrigerante, il compressore aspirerebbe aria e il circuito di refrigerazione raggiungerebbe una pressione eccessiva, con la possibilità di causare lesioni personali.
- Serrare il dado svasato con una chiave torsiometrica come illustrato. Un serraggio eccessivo del dado svasato potrebbe causare delle spaccature nel lungo periodo, il che potrebbe provocare perdite di refrigerante.
- Una volta completata l'installazione è quindi di estrema importanza verificare che non vi siano perdite. Qualora si verifici una perdita di gas refrigerante in una stanza e il gas entri in contatto con delle fiamme, ad esempio in una cucina, si potrebbero generare gas tossici.
- Quando il condizionatore d'aria è stato installato o trasferito, attenersi alle istruzioni nel Manuale d'installazione e spurgare completamente l'aria in modo che nessun altro gas si mescoli al refrigerante nel circuito di refrigerazione. Qualora non si effettui lo spurgo completo dell'aria, si potrebbe provocare un malfunzionamento del condizionatore d'aria.
- Per la prova di tenuta dell'aria è necessario utilizzare gas di azoto.
- Il tubo flessibile di carico deve essere collegato in modo tale da non essere lasco.

Cavi elettrici

- Solo un installatore qualificato(*1) o un tecnico dell'assistenza qualificato(*1) sono autorizzati a eseguire i lavori sull'impianto elettrico per il condizionatore d'aria. In nessuna circostanza tali lavori devono essere effettuati da una persona non qualificata, poiché un'esecuzione non appropriata dei lavori potrebbe provocare scosse elettriche e/o dispersioni di corrente.
- Per collegare i cavi elettrici, riparare parti elettriche o iniziare altri tipi di lavori sull'impianto elettrico, indossare guanti di protezione per elettricisti e resistenti al calore, scarpe e indumenti isolanti, per fornire protezione contro le scosse elettriche. Qualora non si indossino queste attrezzature protettive, si potrebbero provocare scosse elettriche.
- Utilizzare cablaggi che soddisfino le specifiche nel Manuale d'installazione e le direttive delle norme e nelle leggi locali. L'uso di cablaggi che non soddisfino le specifiche potrebbe provocare scosse elettriche, dispersioni di corrente, fumo e/o un incendio.
- Collegare il cavo di terra. (cablaggio di messa a terra)
Una messa a terra incompleta può causare elettrocuzione.
- Non collegare i cavi di messa a terra a tubi del gas, tubi dell'acqua, conduttori dei parafulmini o a cavi di messa a terra per cablaggi telefonici.
- Dopo aver completato i lavori di riparazione o di trasferimento, verificare che i cavi elettrici di messa a terra siano collegati correttamente.
- Installare un interruttore automatico che soddisfi le specifiche nel Manuale d'installazione e le direttive delle norme e delle leggi locali.
- Installare l'interruttore automatico in una sede che sia facilmente accessibile dall'agente.
- Quando si installa l'interruttore automatico all'aperto, installarne uno progettato per l'uso per esterno.
- Non utilizzare in alcuna circostanza prolunghe del cavo elettrico di alimentazione. Problemi di collegamento nelle sedi in cui si trovino prolunghe del cavo elettrico possono provocare fumo e/o un incendio.
- I lavori di cablaggio elettrico devono essere effettuati in conformità alle normative vigenti e al manuale di installazione. La mancata osservanza di questa indicazione espone al rischio di elettrocuzione o cortocircuito.

Prova di funzionamento

- Prima di far funzionare il condizionatore d'aria, dopo aver completato il lavoro, verificare che il coperchio della cassetta dei componenti elettrici dell'unità interna e il pannello di servizio dell'unità esterna siano chiusi, e impostare l'interruttore automatico sulla posizione ON (accesso). Qualora si accenda l'unità senza aver prima eseguito questi controlli, si potrebbe subire una scossa elettrica.

- Se si nota il verificarsi di un problema di qualche tipo con il condizionatore d'aria (ad esempio è stata visualizzata un'indicazione di errore, si sente odore di bruciato, si sentono suoni anomali, il condizionatore d'aria non raffredda o non riscalda, oppure è presente una perdita d'acqua), non toccare da soli il condizionatore d'aria, ma impostare l'interruttore automatico sulla posizione OFF (spento) e contattare un tecnico dell'assistenza qualificato. Adottare delle misure per assicurare che l'unità non venga accesa (ad esempio scrivendo "fuori servizio" in prossimità dell'interruttore automatico) fino all'arrivo di un tecnico dell'assistenza qualificato. L'uso continuato del condizionatore d'aria in questa condizione anomala potrebbe divenire causa di problemi meccanici, generare scosse elettriche o causare altri problemi.
- Al termine del lavoro di riparazione, utilizzare un tester di isolamento (megahmetro tipo Megger da 500 V) per verificare che la resistenza tra la sezione di carica e la sezione metallica di non carica (sezione di terra) sia pari o superiore a 1 MΩ. Qualora il valore di resistenza sia basso, potrebbe verificarsi un grave problema, quale una dispersione o una scossa elettrica, dal lato dell'utente.
- Al completamento del lavoro di installazione, controllare eventuali perdite di refrigerante e controllare la resistenza di isolamento e lo scarico dell'acqua. Quindi, eseguire un funzionamento di prova per controllare che il condizionatore d'aria funzioni correttamente.

Spiegazioni fornite all'utente

- Al completamento del lavoro di installazione, comunicare all'utente dove sia situato l'interruttore automatico. Qualora l'utente non sappia dove si trovi l'interruttore automatico, non sarà in grado di disattivarlo, nell'eventualità che si verifichi un problema con il condizionatore d'aria.
- Se la griglia della ventola è danneggiata, non avvicinarsi all'unità esterna ma impostare l'interruttore automatico sulla posizione OFF (spento) e rivolgersi al tecnico dell'assistenza qualificato (*1) affinché provveda a effettuare le necessarie riparazioni. Non impostare l'interruttore automatico sulla posizione ON (accesso) finché non siano state completate le riparazioni.
- Al termine del lavoro di installazione, seguire il Manuale del proprietario per spiegare al cliente come utilizzare e sottoporre a manutenzione l'unità.

Trasferimento

- Solo un installatore qualificato(*1) o un tecnico dell'assistenza qualificato(*1) sono autorizzati a trasferire il condizionatore d'aria. È pericoloso far trasferire il condizionatore d'aria da una persona non qualificata, in quanto si potrebbero provocare incendi, scosse elettriche, lesioni personali, perdite d'acqua, rumori e/o vibrazioni.
- Quando si eseguono lavori di svuotamento del refrigerante (Pump-down), spegnere il compressore prima di scollegare il tubo del refrigerante. Eseguendo questo scollegamento con la valvola di servizio aperta e il compressore in funzione si causerebbe l'aspirazione dell'aria o di altri gas eventualmente presenti nell'atmosfera, elevando in tal modo la pressione interna al circuito refrigerante a un livello eccessivamente alto con possibili rotture, lesioni personali o problemi di funzionamento.

ATTENZIONE

Installazione del condizionatore d'aria che impiega il nuovo refrigerante

- **QUESTO CONDIZIONATORE D'ARIA UTILIZZA IL NUOVO REFRIGERANTE HFC (R410A) CHE NON DISTRUGGE LO STRATO DI OZONO.**
- Le caratteristiche dell'R410A sono: facilità di assorbimento dell'acqua, membrana od olio ossidante, pressione circa 1,6 superiore a quella dell'R22. Insieme al nuovo refrigerante è stato altresì adottato un nuovo tipo di olio refrigerante. Non lasciare quindi che acqua, polvere, refrigerante precedente o olio di refrigerazione penetrino nel ciclo di refrigerazione durante i lavori di installazione.
- Per impedire la carica accidentale di liquido e olio refrigerante di tipo non corretto le bocche di collegamento dell'unità principale e degli attrezzi d'installazione presentano differenze rispetto a quelle usate con il refrigerante di tipo convenzionale.
- Di conseguenza, per la carica del refrigerante (R410A) è possibile usare soltanto questi attrezzi.
- Per i collegamenti si devono usare tubi nuovi e puliti appositamente concepiti per il refrigerante R410A, impedendo quindi all'acqua e alla polvere di penetrarvi.

Per scollegare l'apparecchio dalla fonte di alimentazione principale.

- Questo apparecchio deve essere collegato alla fonte di alimentazione principale per mezzo di un interruttore con una separazione di contatti di almeno 3 mm.

La linea di alimentazione elettrica del condizionatore deve essere protetta con un fusibile (di qualsiasi tipo).

(*1) Consultare la "Definizione di installatore qualificato o tecnico dell'assistenza qualificato".

Gracias por haber adquirido este aparato de aire acondicionado Toshiba.

Lea atentamente estas instrucciones que contienen información importante de conformidad con la Directiva relativa a "Máquinas" (Directiva 2006/42/EC) y asegúrese de que las entiende.

Tras completar el trabajo de instalación, entregue al usuario este «Manual de instalación» así como el «Manual del propietario» que se suministran y pídales que los guarde en un lugar seguro para poder consultarlos en el futuro.

Denominación genérica: Aire acondicionado

Definición de instalador cualificado o persona de servicio cualificada

El aparato de aire acondicionado deberá ser instalado, mantenido, reparado y desechado por un instalador cualificado o por una persona de servicio cualificada. Cuando se tenga que hacer uno cualquiera de estos trabajos, solicite a un instalador cualificado o a una persona de servicio cualificada que le haga el trabajo solicitado. Un instalador cualificado o una persona de servicio cualificada es un agente con las cualificaciones y conocimientos descritos en la tabla de abajo.

Agente	Cualificaciones y conocimientos que debe tener el agente
Instalador cualificado	<ul style="list-style-type: none"> El instalador cualificado es una persona que se dedica a la instalación, mantenimiento, traslado y retirada de los aparatos de aire acondicionado fabricados por Toshiba Carrier Corporation. Dicha persona habrá recibido formación relativa a la instalación, mantenimiento, traslado y retirada de aparatos de aire acondicionado fabricados por Toshiba Carrier Corporation, o, de otro modo, habrá sido instruida en dichas operaciones por otra u otras personas que hayan recibido formación en la materia y que por tanto posean amplios conocimientos relativos a dichas operaciones. El instalador cualificado que esté autorizado para realizar los trabajos eléctricos propios de la instalación, traslado y retirada poseerá las cualificaciones relativas a dichos trabajos eléctricos, de conformidad con la legislación local vigente, y habrá recibido formación relativa a las tareas eléctricas a realizar en los aparatos de aire acondicionado fabricados por Toshiba Carrier Corporation, o, de otro modo, habrá sido instruido en dichas tareas por otra u otras personas que hayan recibido formación en la materia y que por tanto posean amplios conocimientos relativos a dichas operaciones. El instalador cualificado que esté autorizado para realizar los trabajos de canalización y manejo del refrigerante propios de la instalación, traslado y retirada poseerá las cualificaciones relativas a dichos trabajos de canalización y manejo del refrigerante, de conformidad con la legislación local vigente, y habrá recibido formación relativa a las tareas de canalización y uso del refrigerante a realizar en los aparatos de aire acondicionado fabricados por Toshiba Carrier Corporation, o, de otro modo, habrá sido instruido en dichas tareas por otra u otras personas que hayan recibido formación en la materia y que por tanto posean amplios conocimientos relativos a dichas operaciones. El instalador cualificado que esté autorizado para trabajar en alturas habrá recibido formación relativa a la realización de trabajos en altura con los aparatos de aire acondicionado fabricados por Toshiba Carrier Corporation, o, de otro modo, habrá sido instruido en dichas tareas por otra u otras personas que hayan recibido formación en la materia y que por tanto posean amplios conocimientos relativos a dichos trabajos.
Persona de servicio cualificada	<ul style="list-style-type: none"> La persona de mantenimiento cualificado es una persona que se dedica a la instalación, reparación, mantenimiento, traslado y retirada de los aparatos de aire acondicionado fabricados por Toshiba Carrier Corporation. Dicha persona habrá recibido formación relativa a la instalación, reparación, mantenimiento, traslado y retirada de aparatos de aire acondicionado fabricados por Toshiba Carrier Corporation, o, de otro modo, habrá sido instruida en dichas operaciones por otra u otras personas que hayan recibido formación en la materia y que por tanto posean amplios conocimientos relativos a dichas operaciones. La persona de mantenimiento cualificada que esté autorizada para realizar los trabajos eléctricos propios de la instalación, reparación, traslado y retirada poseerá las cualificaciones relativas a dichos trabajos eléctricos, de conformidad con la legislación local vigente, y habrá recibido formación relativa a las tareas eléctricas a realizar en los aparatos de aire acondicionado fabricados por Toshiba Carrier Corporation, o, de otro modo, habrá sido instruida en dichas tareas por otra u otras personas que hayan recibido formación en la materia y que por tanto posean amplios conocimientos relativos a dichas operaciones. La persona de mantenimiento cualificada que esté autorizada para realizar los trabajos de canalización y manejo del refrigerante propios de la instalación, reparación, traslado y retirada poseerá las cualificaciones relativas a dichos trabajos de canalización y manejo del refrigerante, de conformidad con la legislación local vigente, y habrá recibido formación relativa a las tareas de canalización y uso del refrigerante a realizar en los aparatos de aire acondicionado fabricados por Toshiba Carrier Corporation, o, de otro modo, habrá sido instruida en dichas tareas por otra u otras personas que hayan recibido formación en la materia y que por tanto posean amplios conocimientos relativos a dichas operaciones. La persona de mantenimiento cualificada que esté autorizada para trabajar en alturas habrá recibido formación relativa a la realización de trabajos en altura con los aparatos de aire acondicionado fabricados por Toshiba Carrier Corporation, o, de otro modo, habrá sido instruida en dichas tareas por otra u otras personas que hayan recibido formación en la materia y que por tanto posean amplios conocimientos relativos a dichos trabajos.

Definición del equipo de protección





Cuando vaya a proceder al traslado, instalación, mantenimiento, reparación o retirada del aparato de aire acondicionado, utilice guantes protectores y ropa de trabajo de "seguridad".

Además de este equipo protector habitual, utilice el equipo protector que se describe a continuación cuando emprenda las operaciones especiales que se detallan en la tabla siguiente.

De no utilizar el equipo protector adecuado, incurrirá en cierto riesgo personal ya que estará más expuesto a sufrir heridas, quemaduras, descargas eléctricas y demás lesiones.

Trabajo realizado	Equipo de protección usado
Todo tipo de trabajos	Guantes de protección Ropa de trabajo de "seguridad"
Trabajo relacionado con equipos eléctricos	Guantes para protegerse de las descargas eléctricas y de las altas temperaturas Calzado aislante Ropa que ofrezca protección contra descargas eléctricas
Trabajos en altura (50 cm o más)	Cascos de seguridad de uso industrial
Transporte de objetos pesados	Zapatos con protección adicional en las punteras
Reparación de la unidad exterior	Guantes para protegerse de las descargas eléctricas y de las altas temperaturas

■ Advertencias en cuanto a la unidad de aire acondicionado

Indicación de advertencia		Descripción
	<p>WARNING</p> <p>ELECTRICAL SHOCK HAZARD Disconnect all remote electric power supplies before servicing.</p>	<p>ADVERTENCIAS</p> <p>PELIGRO DE DESCARGA ELÉCTRICA Desconecte todos los suministros eléctricos remotos antes de hacer reparaciones.</p>
	<p>WARNING</p> <p>Moving parts. Do not operate unit with grille removed. Stop the unit before the servicing.</p>	<p>ADVERTENCIAS</p> <p>Piezas móviles. No utilice la unidad con la rejilla retirada. Pare la unidad antes de hacer reparaciones.</p>
	<p>CAUTION</p> <p>High temperature parts. You might get burned when removing this panel.</p>	<p>PRECAUCIÓN</p> <p>Piezas de alta temperatura. Al retirar este panel podría quemarse.</p>
	<p>CAUTION</p> <p>Do not touch the aluminum fins of the unit. Doing so may result in injury.</p>	<p>PRECAUCIÓN</p> <p>No toque las aletas de aluminio del aparato. De lo contrario, podrían producirse lesiones personales.</p>
	<p>CAUTION</p> <p>BURST HAZARD Open the service valves before the operation, otherwise there might be the burst.</p>	<p>PRECAUCIÓN</p> <p>PELIGRO DE ROTURA Abra las válvulas de servicio antes de la operación, de lo contrario podrían producirse roturas.</p>

1 Precauciones de seguridad

El fabricante no se hará responsable de ningún daño producido por no seguir las descripciones de este manual.

ADVERTENCIA

Generalidades

- Antes de empezar a instalar el acondicionador de aire, lea atentamente el manual de instalación y siga sus instrucciones para instalarlo.
- Solo un instalador cualificado o una persona de mantenimiento cualificada tiene permiso para realizar los trabajos de instalación. La instalación incorrecta puede provocar fugas de agua, descargas eléctricas o incendios.
- No utilice ningún refrigerante distinto del especificado como complemento o sustituto. Si lo hace, se podría generar una presión extremadamente alta en el ciclo de refrigeración, lo que podría causar un fallo en el producto, la explosión de este o daños físicos.
- Antes de abrir la rejilla de admisión de la unidad interior o el panel de servicio de la unidad exterior, ponga el disyuntor en la posición OFF. Si no se pone el disyuntor en la posición OFF se puede producir una descarga eléctrica al tomar las piezas interiores. Sólo un instalador cualificado(*1) o una persona de servicio cualificada(*1) tiene permitido retirar la rejilla de admisión de la unidad interior o el panel de servicio de la unidad exterior y hacer el trabajo necesario.
- Antes de realizar la instalación, el mantenimiento, la reparación o la desinstalación, coloque el disyuntor en la posición de apagado (OFF). De lo contrario se pueden producir descargas eléctricas.
- Ponga un aviso que diga "trabajo en curso" cerca del disyuntor mientras se realiza el trabajo de instalación, mantenimiento, reparación o desecho. Si el disyuntor se pone en ON por error existe el peligro de que se produzcan descargas eléctricas.
- Sólo un instalador cualificado(*1) o una persona de servicio cualificada(*1) tiene permiso para realizar trabajos en lugares altos usando una base de 50 cm o más o para quitar la rejilla de admisión de la unidad interior para realizar otros trabajos.
- Póngase guantes de protección y ropa de trabajo segura durante la instalación, reparación y desecho.
- No toque la aleta de aluminio de la unidad. Si lo hace puede lesionarse usted mismo. Si la aleta tiene que tocarse por alguna razón, póngase primero guantes de protección y ropa de trabajo segura, y luego empiece a trabajar.
- No se suba encima ni coloque objetos encima de la unidad exterior. Usted o los objetos pueden caerse de la unidad exterior y provocar lesiones.
- Cuando trabaje en alturas, utilice una escalera que cumpla la norma ISO 14122 y siga los procedimientos indicados en las instrucciones de la escalera. Póngase también un casco de uso industrial como equipo de protección para hacer el trabajo.
- Cuando vaya a limpiar el filtro u otra parte de la unidad exterior coloque el disyuntor en la posición de apagado (OFF), asegúrese de que queda en dicha posición y coloque un cartel que indique que se están realizando tareas de mantenimiento antes de comenzar.
- Cuando vaya a trabajar en alturas, coloque un cartel en el lugar adecuado antes de comenzar para que nadie se aproxime a la zona de trabajo. Desde la parte superior podrían caer piezas y otros objetos que causarían lesiones a las personas situadas debajo. Cuando esté realizando un trabajo, utilice casco para protegerse de los objetos que pudieran caer.
- El refrigerante usado por este aparato de aire acondicionado es el R410A.
- La unidad de aire acondicionado se debe transportar en condiciones de estabilidad adecuadas. Si alguna pieza del producto está rota, póngase en contacto con el proveedor.
- Cuando la unidad de aire acondicionado se deba transportar con las manos, deberán hacerlo dos o más personas.
- No mueva ni repare ninguna unidad usted mismo. La unidad contiene alto voltaje en su interior. Podría recibir una descarga eléctrica al retirar la cubierta y la unidad principal.

Selección del lugar de instalación

- Cuando la unidad de aire acondicionado se instale en una habitación pequeña, asegúrese de que las medidas son adecuadas para garantizar que la concentración de refrigerante que se produce por la fuga de este en la habitación no sobrepase el nivel crítico.
- No instale el producto en una ubicación donde puedan darse fugas de gas. Si se produjera una fuga de gas y este se acumulara alrededor de la unidad, podría prender y provocarse un incendio.
- Utilice calzado con protección adicional para el extremo del pie cuando transporte la unidad de aire acondicionado.
- No agarre las bandas que rodean la caja del embalaje para transportar la unidad de aire acondicionado. Usted podría lesionarse si se rompieran las bandas.
- Instale la unidad interior a 2,5 m como mínimo por encima del nivel del suelo, ya que de lo contrario los usuarios podrían lesionarse o recibir descargas eléctricas si meten sus dedos u otros objetos en la unidad interior mientras funciona el aparato de aire acondicionado.
- No ponga ningún aparato de combustión en un lugar expuesto directamente al aire procedente del aparato de aire acondicionado, de lo contrario, la combustión no sería perfecta.

Instalación

- Cuando la unidad interior vaya a instalarse suspendida deberán usarse los pernos para colgar (M10 ó W3/8) y las tuercas (M10 ó W3/8) que han sido designados.
- Instale la unidad de aire acondicionado asegurándose de que queda bien sujeta en una ubicación cuya base pueda soportar el peso adecuadamente. Si la resistencia no es suficiente, la unidad puede caerse y causar lesiones.
- Siga las instrucciones del manual de instalación para instalar el aparato de aire acondicionado. De no seguir esta instrucción, el producto podría caer o volcarse, así como generar más ruido, vibraciones, fugas de agua y otros problemas.
- Lleve a cabo el procedimiento de instalación especificado para proteger la unidad contra posibles vientos fuertes y terremotos. Si no se instala la unidad de aire acondicionado correctamente, podría caer o volcarse y causar un accidente.
- Si se producen fugas de gas refrigerante durante la instalación, ventile inmediatamente la habitación. Si la fuga de refrigerante entra en contacto con fuego, se podrían generar gases tóxicos.
- Utilice una carretilla elevadora para transportar las unidades de aire acondicionado y cabestrantes o montacargas para la instalación.

Tubería del refrigerante

- Instale firmemente el tubo del refrigerante durante los trabajos de instalación antes de poner en funcionamiento el aparato de aire acondicionado. Si el compresor funciona con su válvula abierta y sin tubo de refrigerante, el compresor succionará aire y los ciclos de refrigeración tendrán una presión excesiva, lo que puede causar lesiones.
- Apriete la tuerca abocinada con una llave de ajuste dinamo-métrica como se indica. Un apriete excesivo de tuerca abocinada puede causar grietas en la misma después de pasar mucho tiempo, lo que podría causar fugas de refrigerante.
- Tras la instalación, asegúrese de que no existen fugas de gas refrigerante. Si se produce una fuga de gas refrigerante en la habitación y hay una fuente de fuego próxima, como una cocina, podría generarse gas nocivo.
- Cuando el aparato de aire acondicionado haya sido instalado o recolocado, siga las instrucciones del manual de instalación y purgue completamente el aire para que no se mezclen otros gases que no sean el refrigerante en el ciclo de refrigeración. Si el aire no se purga completamente puede que el aparato de aire acondicionado funcione mal.
- Para la prueba de hermeticidad al aire deberá usarse nitrógeno.
- La manguera de carga deberá conectarse de forma que no esté floja.

Cableado eléctrico

- Sólo un instalador cualificado(*1) o una persona de servicio cualificada(*1) tiene permitido realizar el trabajo eléctrico del aparato de aire acondicionado. Este trabajo no deberá hacerlo, bajo ninguna circunstancia, un individuo que no esté cualificado, porque si el trabajo se hace mal, existe el peligro de que se produzcan descargas eléctricas y/o fugas eléctricas.
- Cuando conecte cables eléctricos, repare piezas eléctricas o lleve a cabo otros trabajos eléctricos, utilice guantes de protección contra la electricidad y el calor así como calzado y ropa aislante para protegerse de las descargas eléctricas. Si no se pone este equipo de protección puede recibir descargas eléctricas.
- Use cables que cumplan con las especificaciones del manual de instalación y las estipulaciones de las normas y leyes locales. El uso de cables que no cumplen con las especificaciones puede dar origen a descargas eléctricas, fugas eléctricas, humo y/o incendios.
- Conecte la toma de tierra. (Masa)
Si la unidad no está totalmente conectada al cable de tierra, podría producir descargas eléctricas.
- No conecte la toma de tierra a tuberías de gas o agua, a un pararrayos ni a una toma de tierra de teléfono.
- Cuando haya finalizado un trabajo de reparación o reubicación, compruebe que la toma de tierra esté conectada adecuadamente.
- Instale un disyuntor que cumpla con las especificaciones del manual de instalación y con las estipulaciones de las normas y las leyes locales.
- Instale el disyuntor donde el agente pueda tener acceso a él fácilmente.
- Cuando instale el disyuntor en el exterior, instale uno diseñado para ser usado en exteriores.
- No se debe utilizar una extensión para el cable de alimentación bajo ninguna circunstancia. Los problemas de conexión en el lugar donde se utiliza la extensión para el cable podrían generar humo y fuego.
- El cableado eléctrico deberá realizarse de conformidad con la legislación local vigente y el Manual de instalación. No se ser así, podría producirse una electrocución o un cortocircuito.

Prueba de funcionamiento

- Antes de utilizar el aparato de aire acondicionado después de completar el trabajo de instalación, verifique que la cubierta de la caja de componentes eléctricos de la unidad interior y del panel de servicio de la unidad exterior esté cerrada, y ponga el disyuntor en la posición ON. Si conecta la alimentación sin realizar primero estas verificaciones puede recibir una descarga eléctrica.
- Si surge cualquier problema (por ejemplo, si aparece un error en la pantalla, huele a quemado, se producen sonidos anormales, la unidad no enfría o no calienta o se produce una fuga de agua) con la unidad de aire acondicionado, no la toque usted mismo; coloque el disyuntor en la posición de apagado (OFF) y póngase en contacto con personal de servicio cualificado. Tome medidas (poniendo un aviso de "fuera de servicio" cerca del disyuntor, por ejemplo)

para asegurar que la alimentación no se conecte antes de que llegue la persona de servicio cualificada. Si se continúa utilizando la unidad de aire acondicionado con la anomalía, los problemas mecánicos podrían generar otras complicaciones o provocar descargas eléctricas u otro tipo de problemas.

- Cuando haya finalizado el trabajo, compruebe mediante un medidor de aislamiento (Megger de 500 V) que la resistencia entre el elemento de carga y el elemento metálico neutro (de tierra) sea de 1 MΩ o más. Si el valor de la resistencia es bajo, esto se debe a un fallo como, por ejemplo, una fuga o una descarga eléctrica en el lado del usuario.
- Al completar el trabajo de instalación, verifique que no haya fugas de refrigerante, y también la resistencia del aislamiento y el drenaje de agua. Luego haga una prueba de funcionamiento para verificar si el aparato de aire acondicionado funciona correctamente.

Explicaciones para dar al usuario

- Al finalizar el trabajo de instalación dígame al usuario dónde está situado el disyuntor. Si el usuario no sabe dónde está el disyuntor, él o ella no podrán desconectar la alimentación en el caso de que se produzca un fallo en el aparato de aire acondicionado.
- Si la rejilla del ventilador se encuentra dañada, no se acerque a la unidad exterior; coloque el disyuntor en la posición de apagado (OFF) y póngase en contacto con personal de servicio cualificado(*1) para que realice la reparación. No ponga el disyuntor en la posición ON hasta después de terminar las reparaciones.
- Después de hacer el trabajo de instalación, siga las indicaciones del manual del propietario para explicar al cliente cómo usar y mantener la unidad.

Recolocación

- Sólo un instalador cualificado(*1) o una persona de servicio cualificada(*1) tiene permiso para recolocar el aparato de aire acondicionado. Es peligroso para el aparato de aire acondicionado que sea recolocado por un individuo no cualificado, porque se puede producir un incendio, descargas eléctricas, lesiones, fugas de agua, ruido y/o vibración.
- Cuando realice trabajos de bombeo de vacío, cierre el compresor antes de desconectar el tubo del refrigerante. Si se desconecta el tubo de refrigerante con la válvula de mantenimiento abierta y el compresor aún en marcha, se aspirará aire u otro gas, elevando la presión dentro del ciclo de refrigeración a niveles anormalmente altos, lo que podrá provocar roturas, lesiones u otros problemas.

⚠ PRECAUCIÓN

Instalación del aparato de aire acondicionado con nuevo refrigerante

• ESTE APARATO DE AIRE ACONDICIONADO INCORPORA EL NUEVO REFRIGERANTE HFC (R410A) RESPETUOSO CON LA CAPA DE OZONO.

- Las características del refrigerante R410A son: fácil absorción de agua, oxidación de membrana o aceite; con una presión de aproximadamente 1,6 veces mayor que la del R22. Junto con el nuevo refrigerante, se ha cambiado también el aceite refrigerante. Por tanto, no deje que entre agua, polvo, refrigerante anterior o aceite refrigerante en el ciclo de refrigeración durante la instalación.
- Para evitar errores en la carga del refrigerante y el aceite refrigerante, se han cambiado los tamaños de las secciones de conexión del orificio de carga de la unidad principal y las herramientas de instalación para diferenciarlos del refrigerante convencional.
- Por lo tanto, es necesario emplear herramientas exclusivas para el nuevo refrigerante (R410A).
- Para conectar los tubos, utilice tubería nueva y limpia diseñada para R410A, y tenga la precaución de evitar la entrada de agua o polvo.

Para desconectar el dispositivo de la fuente de alimentación.

- Este dispositivo debe conectarse a la fuente de alimentación mediante un interruptor cuya separación de contacto sea como mínimo de 3 mm.

Se debe utilizar un fusible de instalación (de cualquier tipo) para la línea de alimentación eléctrica de esta unidad.

(*1) Consulte la "definición de instalador cualificado o persona de servicio cualificada".

Obrigado por ter adquirido este ar condicionado Toshiba.

Leia estas instruções com cuidado, pois contém informação importante que cumpre a Directiva "Máquinas" (Directiva 2006/42/CE), e assegure-se de que as entende.

Depois de concluir o trabalho de instalação, entregue este Manual de Instalação e o Manual do Proprietário que acompanha a unidade exterior ao utilizador, e peça ao utilizador para guardá-los num lugar seguro para futuras consultas.

Denominação Genérica: Ar Condicionado

Definição de Instalador Qualificado ou de Técnico de Assistência Qualificado

O ar condicionado deve ser instalado, mantido, reparado e eliminado por um instalador qualificado ou um técnico de assistência qualificado. Quando for necessário efectuar qualquer um destes trabalhos, peça a um instalador qualificado ou a um técnico de assistência qualificado para efectuar estes trabalhos.

Um instalador qualificado ou um técnico de assistência qualificado é um agente com as qualificações e os conhecimentos descritos na tabela abaixo.

Agente	Qualificações e conhecimentos necessários do agente
Instalador qualificado	<ul style="list-style-type: none"> O instalador qualificado é uma pessoa que instala, dá manutenção a, muda de lugar e remove os ares condicionados fabricados pela Toshiba Carrier Corporation. Esta pessoa deve ter formação para instalar, dar manutenção a, mudar de lugar e remover ares condicionados fabricados pela Toshiba Carrier Corporation ou, como alternativa, deve ter sido instruída nessas operações por parte de indivíduos com a formação devida e, portanto, que adquiriram todo o conhecimento relacionado com estas operações. O instalador qualificado que tem permissão para levar a cabo as ligações eléctricas envolvidas na instalação, deslocação e remoção tem as qualificações necessárias para realizar essas tarefas conforme estipulado pelas leis e regulamentos locais, sendo uma pessoa que fez formação nas matérias relacionadas com trabalho eléctrico nos ares condicionados fabricados pela Toshiba Carrier Corporation ou, como alternativa, que foi instruída nessas matérias por parte de indivíduos com a formação devida e, portanto, que adquiriram todo o conhecimento relacionado com este trabalho. O instalador qualificado que tem permissão para realizar as tarefas de manuseamento do refrigerante e de instalação das tubagens envolvidas na instalação, deslocação e remoção dos aparelhos tem as qualificações necessárias para o manuseamento do refrigerante e a instalação das tubagens conforme estipulado pelas leis e regulamentos locais, sendo uma pessoa que fez formação nas matérias relacionadas com o manuseamento de refrigerante e a instalação de tubagens nos ares condicionados fabricados pela Toshiba Carrier Corporation ou, como alternativa, que foi instruída nessas matérias por parte de indivíduos com a formação devida e, portanto, que adquiriram todo o conhecimento relacionado com estas tarefas. O instalador qualificado, a quem é permitido trabalhar em altura, foi formado em matérias relacionadas com o trabalho em altura com ares condicionados fabricados pela Toshiba Carrier Corporation ou, como alternativa, foi instruído nessas matérias por indivíduos com a formação devida e, portanto, que adquiriram todo o conhecimento relacionado com este trabalho.
Técnico de assistência qualificado	<ul style="list-style-type: none"> O técnico de assistência qualificado é uma pessoa que instala, repara, dá manutenção a, muda de lugar e remove os ares condicionados fabricados pela Toshiba Carrier Corporation. Esta pessoa deve ter formação para instalar, reparar, dar manutenção a, mudar de lugar e remover ares condicionados fabricados pela Toshiba Carrier Corporation ou, como alternativa, deve ter sido instruído nessas operações por parte de indivíduos com a formação devida e, portanto, que adquiriram todo o conhecimento relacionado com estas operações. O técnico de assistência qualificado que tem permissão para levar a cabo as ligações eléctricas envolvidas na instalação, reparação, deslocação e remoção tem as qualificações necessárias para realizar essas tarefas conforme estipulado pelas leis e regulamentos locais, sendo uma pessoa que fez formação nas matérias relacionadas com trabalho eléctrico nos ares condicionados fabricados pela Toshiba Carrier Corporation ou, como alternativa, que foi instruída nessas matérias por parte de indivíduos com a formação devida e, portanto, que adquiriram todo o conhecimento relacionado com este trabalho. O técnico de assistência qualificado que tem permissão para realizar as tarefas de manuseamento do refrigerante e de instalação das tubagens envolvidas na instalação, reparação, deslocação e remoção dos aparelhos tem as qualificações necessárias para o manuseamento do refrigerante e a instalação das tubagens conforme estipulado pelas leis e regulamentos locais, sendo uma pessoa que fez formação nas matérias relacionadas com o manuseamento de refrigerante e a instalação de tubagens nos ares condicionados fabricados pela Toshiba Carrier Corporation ou, como alternativa, que foi instruída nessas matérias por parte de indivíduos com a formação devida e, portanto, que adquiriram todo o conhecimento relacionado com estas tarefas. O técnico de assistência qualificado, a quem é permitido trabalhar em altura, foi formado em matérias relacionadas com o trabalho em altura com ares condicionados fabricados pela Toshiba Carrier Corporation ou, como alternativa, foi instruído nessas matérias por indivíduos com a formação devida e, portanto, que adquiriram todo o conhecimento relacionado com este trabalho.

Definição do Equipamento de Protecção





Aquando do transporte, instalação, manutenção, reparação ou remoção do ar condicionado, use luvas e vestuário de protecção.

Além do equipamento de protecção normal, use o equipamento de protecção descrito abaixo, se levar a cabo os trabalhos especiais detalhados na tabela abaixo.

É perigoso não usar o equipamento de protecção adequado porque fica mais susceptível a sofrer lesões, queimaduras, choques eléctricos e outros ferimentos.

Trabalho efectuado	Equipamento de protecção usado
Todos os tipos de trabalhos	Luvas de protecção Vestuário de protecção
Trabalho eléctrico	Luvas para proteger electricistas e calor Sapatos isoladores Vestuário que proteja contra choques eléctricos
Trabalhos em altura (50 cm ou mais)	Capacetes industriais
Transporte de objectos pesados	Sapatos com protecção adicional para os dedos dos pés
Reparação da unidade exterior	Luvas para proteger electricistas e calor

■ Indicações de aviso sobre o ar condicionado

Indicação de aviso	Descrição		
 <table border="1"> <tr> <td>WARNING</td> </tr> <tr> <td>ELECTRICAL SHOCK HAZARD Disconnect all remote electric power supplies before servicing.</td> </tr> </table>	WARNING	ELECTRICAL SHOCK HAZARD Disconnect all remote electric power supplies before servicing.	ADVERTÊNCIAS PERIGO DE CHOQUE ELÉCTRICO Desligue todas as fontes de alimentação eléctrica remotas antes de uma operação de assistência.
WARNING			
ELECTRICAL SHOCK HAZARD Disconnect all remote electric power supplies before servicing.			
 <table border="1"> <tr> <td>WARNING</td> </tr> <tr> <td>Moving parts. Do not operate unit with grille removed. Stop the unit before the servicing.</td> </tr> </table>	WARNING	Moving parts. Do not operate unit with grille removed. Stop the unit before the servicing.	ADVERTÊNCIAS Peças rotativas. Não utilize a unidade com a grelha retirada. Pare a unidade antes de uma operação de assistência.
WARNING			
Moving parts. Do not operate unit with grille removed. Stop the unit before the servicing.			
 <table border="1"> <tr> <td>CAUTION</td> </tr> <tr> <td>High temperature parts. You might get burned when removing this panel.</td> </tr> </table>	CAUTION	High temperature parts. You might get burned when removing this panel.	PRECAUÇÃO Peças com elevadas temperaturas. Pode queimar-se quando retirar este painel.
CAUTION			
High temperature parts. You might get burned when removing this panel.			
 <table border="1"> <tr> <td>CAUTION</td> </tr> <tr> <td>Do not touch the aluminum fins of the unit. Doing so may result in injury.</td> </tr> </table>	CAUTION	Do not touch the aluminum fins of the unit. Doing so may result in injury.	PRECAUÇÃO Não toque nas barbatanas de alumínio da unidade. Caso contrário, poderá ferir-se.
CAUTION			
Do not touch the aluminum fins of the unit. Doing so may result in injury.			
 <table border="1"> <tr> <td>CAUTION</td> </tr> <tr> <td>BURST HAZARD Open the service valves before the operation, otherwise there might be the burst.</td> </tr> </table>	CAUTION	BURST HAZARD Open the service valves before the operation, otherwise there might be the burst.	PRECAUÇÃO PERIGO DE EXPLOSÃO Abra as válvulas de serviço antes de utilizar o equipamento, caso contrário, pode ocorrer uma explosão.
CAUTION			
BURST HAZARD Open the service valves before the operation, otherwise there might be the burst.			

1 Precauções de segurança

O fabricante não assumirá nenhuma responsabilidade por danos causados pela não observação das descrições dadas neste manual.

AVISO

Geral

- Antes de instalar o ar condicionado, leia cuidadosamente o Manual de Instalação e siga as instruções fornecidas para instalar o ar condicionado.
- Apenas um instalador qualificado ou um técnico de assistência qualificado pode efectuar o trabalho de instalação. A instalação incorrecta pode provocar fugas de água, choques eléctricos ou incêndio.
- Não utilize um refrigerante diferente do especificado para complementação ou substituição. Caso contrário, uma pressão anormalmente alta pode ser gerada no ciclo de refrigeração, o que pode resultar numa falha ou explosão do produto ou em ferimentos pessoais.
- Antes de abrir a grelha de entrada da unidade interior ou painel de serviço da unidade exterior, coloque o disjuntor eléctrico na posição OFF. A não colocação do disjuntor eléctrico na posição OFF pode provocar choques eléctricos devido ao contacto com as peças internas. Apenas um instalador qualificado(*1) ou um técnico de assistência qualificado(*1) pode retirar a grelha de entrada da unidade interior ou o painel de serviço da unidade exterior e efectuar os trabalhos necessários.
- Antes de efectuar o trabalho de instalação, manutenção, reparação ou de eliminação, coloque o disjuntor eléctrico na posição OFF. Caso contrário, podem ocorrer choques eléctricos.
- Coloque um sinal "Trabalho em progresso" junto ao disjuntor eléctrico durante a realização de trabalhos de instalação, manutenção, reparação ou eliminação. Existe um perigo de choques eléctricos se colocar o disjuntor eléctrico na posição ON por engano.
- Apenas um instalador qualificado(*1) ou um técnico de assistência qualificado(*1) pode efectuar o trabalho em altura com um suporte de 50 cm ou mais, ou retirar a grelha de entrada da unidade interior para efectuar o trabalho.
- Use luvas de protecção e vestuário de trabalho de segurança durante a instalação, a assistência e a eliminação.
- Não toque na barbatana de alumínio da unidade. Pode ferir-se, se o fizer. Se for necessário tocar na palheta por algum motivo, coloque primeiro as luvas de protecção e o vestuário de trabalho de segurança e, em seguida, prossiga.
- Não suba para nem coloque objectos sobre a unidade exterior. Pode cair ou os objectos podem cair da unidade exterior e provocar ferimentos.
- Quando trabalhar em altura, utilize uma escada em conformidade com a norma ISO 14122 e efectue o procedimento descrito nas instruções da escada. Use também um capacete industrial como equipamento de protecção para efectuar o trabalho.
- Antes de limpar o filtro ou outras peças da unidade exterior, não se esqueça de colocar o disjuntor eléctrico na posição OFF e um sinal "Trabalho em progresso" junto ao disjuntor eléctrico antes de continuar o trabalho.
- Antes de trabalhar em altura, coloque um sinal no local para que ninguém se aproxime do local de trabalho antes de continuar com o trabalho. As peças e outros objectos podem cair da parte superior, ferindo possivelmente uma pessoa que esteja por baixo. Enquanto realiza o trabalho, utilize um capacete para protecção contra a queda de objectos.
- O refrigerante utilizado por este ar condicionado é o R410A.
- O aparelho de ar condicionado deve ser transportado numa condição estável. Se encontrar qualquer parte do produto quebrada, contacte o seu revendedor.
- Se o aparelho de ar condicionado tiver que ser transportado manualmente, duas ou mais pessoas devem carregá-lo.
- Não mova ou repare qualquer unidade. Há tensão alta no interior da unidade. Pode sofrer um choque eléctrico quando retirar a tampa e a unidade principal.

Seleção do local de instalação

- Quando o aparelho de ar condicionado for instalado em um ambiente pequeno, providencie medidas apropriadas para assegurar que a concentração de fuga do refrigerante que possa ocorrer no ambiente não exceda o nível crítico.
- Não instale num local onde gases inflamáveis possam vaziar. Se algum gás vaziar e acumular-se ao redor da unidade, o mesmo pode inflamar e causar um incêndio.
- Para transportar o ar condicionado, use sapatos com protecções adicionais para os dedos dos pés.
- Para transportar o ar condicionado, não segure nas faixas existentes à volta da embalagem de cartão. Pode ferir-se, se as faixas se partirem.
- Instale a unidade interior a pelo menos 2,5 m acima do nível do chão, caso contrário, os utilizadores podem ferir-se ou sofrerem choques eléctricos se tocarem com os dedos ou outros objectos na unidade interior com o ar condicionado em funcionamento.
- Não coloque nenhum aparelho de combustão num local exposto directamente ao vento do ar condicionado, caso contrário, pode provocar uma combustão imperfeita.

Instalação

- Quando suspender a unidade interior, tem de utilizar as porcas (M10 ou W3/8) e os parafusos de fixação (M10 ou W3/8).
- Instale o aparelho de ar condicionado firmemente num lugar onde a base possa suportar o peso adequadamente. Se a força não for suficiente, a unidade pode cair e provocar lesões.

- Siga as instruções fornecidas no Manual de Instalação para instalar o ar condicionado. O incumprimento destas instruções pode provocar a queda do produto ou produzir ruído, vibração, vazamento de água ou outros problemas.
- Realize o trabalho de instalação especificado para a protecção adequada contra a possibilidade de ventos fortes e terremotos. Se o aparelho de ar condicionado não for instalado adequadamente, uma unidade pode tombar ou cair, provocando um acidente.
- Se o gás refrigerante vazar durante o trabalho de instalação, ventile o ambiente imediatamente. Se o gás refrigerante vazado entrar em contacto com fogo, poderá ser gerado um gás nocivo.
- Utilize uma empilhadora para transportar as unidades do aparelho de ar condicionado e utilize um guincho ou guindaste para sua instalação.

Tubagem do refrigerante

- Instale correctamente o tubo de refrigeração durante a instalação antes de colocar o ar condicionado em funcionamento. Se operar o compressor com a válvula aberta e sem o tubo de refrigerante, o compressor suga o ar e os ciclos de refrigeração ficam sobrepresurizados, esta situação pode provocar uma lesão.
- Aperte a porca de alargamento com uma chave dinamométrica e da forma especificada. O aperto excessivo da porca de alargamento pode provocar uma rachadura na porca de alargamento após um longo período, que pode resultar na fuga de refrigerante.
- Após o trabalho de instalação, confirme que não haja nenhuma fuga do gás refrigerante. Se houver uma fuga de gás refrigerante para o compartimento que entre em contacto com uma chama, por exemplo, no caso de um fogão, poderá gerar gás tóxico.
- Quando instalar ou mudar o ar condicionado, siga as instruções fornecidas no Manual de Instalação e elimine o ar completamente para que nenhum gás para além do refrigerante seja misturado no ciclo de refrigeração. A não eliminação completa do ar pode provocar uma avaria no ar condicionado.
- Tem de utilizar gás de nitrogénio para o teste de impermeabilidade.
- Tem de ligar o tubo de carga para que não exista nenhuma fuga.

Cablagem eléctrica

- Apenas um instalador qualificado(*1) ou um técnico de assistência qualificado(*1) pode efectuar o trabalho eléctrico do ar condicionado. Este trabalho não deve ser efectuado por uma pessoa não qualificada em nenhuma circunstância porque um trabalho executado incorrectamente pode resultar em choques eléctricos e/ou fugas eléctricas.
- Para conectar os cabos eléctricos, reparar peças eléctricas ou efectuar outros trabalhos eléctricos, utilize luvas para protecção de electricistas e calor, sapatos isoladores e vestuário para a protecção contra choques eléctricos. A não utilização deste equipamento de protecção pode resultar em choques eléctricos.
- Utilize cablagens que cumpram as especificações fornecidas no Manual de Instalação e as condições nas leis e regulamentos locais. A utilização de cablagens que não cumpram as especificações pode originar choques eléctricos, fugas eléctricas, fumo e/ou um incêndio.
- Conecte o cabo de terra. (fio de terra)
Se a ligação à terra ficar incompleta, podem ocorrer choques eléctricos.
- Não conecte os cabos de terra a tubos de gás, tubos de água, pára-raios ou fios de terra de telefone.
- Depois de concluir o trabalho de reparação ou mudança, verifique se os fios de terra estão ligados correctamente.
- Instale um disjuntor eléctrico que cumpra as especificações fornecidas no manual de instalação e as condições nas leis e regulamentos locais.
- Instale o disjuntor eléctrico num local de fácil acesso ao agente.
- Quando instalar um disjuntor eléctrico no exterior, instale um disjuntor concebido para utilizar no exterior.
- Não deve estender o cabo de alimentação em nenhuma circunstância. O problema da ligação em locais em que o cabo é ampliado pode originar fumo e/ou um incêndio.
- O trabalho de ligação de cabos e fios eléctricos deve ser feito em conformidade com as leis e regulamentos da comunidade em questão e com o manual de instalação.
Se assim não for, o resultado pode ser electrocussão ou curto-circuito.

Teste de funcionamento

- Antes de utilizar o ar condicionado após a conclusão do trabalho, verifique se a tampa da caixa do equipamento eléctrico da unidade interior e o painel de serviço da unidade exterior estão fechados e coloque o disjuntor eléctrico na posição ON. Pode sofrer um choque eléctrico se ligar a corrente eléctrica sem efectuar primeiro estas verificações.
- Quando detectar algum tipo de problema (como, por exemplo, quando aparecer uma indicação de erro, cheiro a queimado, sons anormais, o ar condicionado não arrefecer ou aquecer, ou existir uma fuga de água) no aparelho de ar condicionado, não toque no ar condicionado, mas coloque o disjuntor eléctrico na posição desligada (OFF) e contacte um técnico de assistência qualificado. Tome as medidas necessárias para garantir que a corrente eléctrica não será ligada (através da colocação do aviso "fora de serviço" junto ao disjuntor de serviço, por exemplo) até chegar o técnico de assistência qualificado. Se continuar a utilizar o ar condicionado com problemas, pode aumentar a ocorrência de problemas mecânicos e provocar choques eléctricos ou outros problemas.
- Terminados os trabalhos, utilize um aparelho de testes de isolamento (megaohmímetro de 500 V) para assegurar que a resistência é de 1 MΩ ou mais entre a secção de carga e a secção metálica sem carga (secção de terra). Se o valor da resistência for baixo, ocorre uma fuga ou um choque eléctrico no lado do utilizador.
- Depois de concluir o trabalho de instalação, verifique se existem fugas de refrigerante, a resistência do isolamento e a drenagem de água. Realize um teste para verificar se o ar condicionado está a funcionar correctamente.

Explicações fornecidas ao utilizador

- Depois de concluir o trabalho de instalação, indique o local de instalação do disjuntor eléctrico ao utilizador. Se o utilizador não souber a localização do disjuntor eléctrico, não será capaz de o desligar no caso de ocorrer um problema no ar condicionado.
- Se a grelha da ventoinha estiver danificada, não se aproxime da unidade exterior, mas coloque o disjuntor na posição desligada (OFF) e contacte um técnico de assistência qualificado(*1) para proceder à reparação. Não coloque o disjuntor eléctrico na posição ON até ao fim das reparações.
- Depois de concluir o trabalho de instalação, utilize o Manual do Proprietário para explicar ao cliente como utilizar e manter a unidade.

Mudança

- Apenas um instalador qualificado(*1) ou um técnico de assistência qualificado(*1) pode mudar o ar condicionado. É perigoso o ar condicionado ser mudado por uma pessoa não qualificada porque pode ocorrer um incêndio, choques eléctricos, lesões, fugas de água, ruídos e/ou vibrações.
- Quando efectuar o trabalho de bombagem, encerre o compressor antes de desligar o tubo de refrigerante. Se desconectar o tubo do refrigerante com a válvula de serviço ainda aberta e o compressor ainda em funcionamento, faz com que o ar ou outros gases sejam aspirados, aumentando a pressão interna do ciclo de refrigeração para um nível anormalmente elevado, podendo causar a ruptura, lesões ou outros problemas.

⚠ ATENÇÃO

Instalação do ar condicionado de novo refrigerante

- **ESTE APARELHO DE AR CONDICIONADO UTILIZA O NOVO REFRIGERANTE HFC (R410A) QUE NÃO DESTROÍ A CAMADA DE OZONO.**
- As características do refrigerante R410A são: absorve com facilidade a água, membrana oxidante ou óleo, e a sua pressão é aproximadamente 1,6 vez mais alta do que a do refrigerante R22. O óleo de refrigeração também foi modificado em conformidade com o novo refrigerante. Portanto, durante o trabalho de instalação, certifique-se de impedir a entrada de água, poeira, refrigerante anterior ou óleo de refrigeração no ciclo de refrigeração.
- Para prevenir o carregamento dum refrigerante ou óleo de refrigeração incorrecto, os tamanhos das secções de conexão do orifício de carga da unidade principal e das ferramentas de instalação foram modificados dos tamanhos utilizados para o refrigerante convencional.
- Portanto, é preciso utilizar ferramentas especiais para o novo refrigerante (R410A).
- Para a conexão da tubagem, utilize uma tubagem nova e limpa projectada para o refrigerante R410A, e tome cuidado para evitar a entrada de água ou poeira.

Para desligar o aparelho da alimentação eléctrica principal.

- Este aparelho tem de ser ligado à alimentação eléctrica principal através de um interruptor com uma distância de contacto de, pelo menos, 3 mm.

Deve utilizar um fusível de instalação (qualquer tipo pode ser utilizado) para a linha de fornecimento de energia deste ar condicionado.

(*1) Consulte a "Definição de Instalador Qualificado ou de Técnico de Assistência Qualificado".

Hartelijk dank voor uw aankoop van deze Toshiba-airconditioner.

Lees deze instructies zorgvuldig. Ze bevatten informatie die voldoet aan de richtlijn voor "Machines" (richtlijn 2006/42/EC). Zorg dat u de instructies begrijpt.

Geef na het installeren deze Installatiehandleiding en tevens de bij de buitenunit geleverde Gebruiksaanwijzing aan de klant/gebruiker en vraag hem/haar de documentatie ter referentie op een veilige plaats te bewaren.

Algemene beschrijving: Airconditioner

Definitie van bevoegd installateur of bevoegd onderhoudsmonteur

De airconditioner moet worden geïnstalleerd, onderhouden, gerepareerd en uiteindelijk weggedaan door een bevoegd installateur of bevoegd onderhoudsmonteur. Wanneer een van deze taken verricht moet worden, verzoekt u dan een bevoegd installateur of bevoegd onderhoudsmonteur om dit voor u te doen.

Een bevoegd installateur of bevoegd onderhoudsmonteur is een persoon die beschikt over de kennis en bevoegdheden die staan vermeld in de onderstaande tabel.

Persoon	Kennis en bevoegdheden waarover de persoon moet beschikken
Bevoegd installateur	<ul style="list-style-type: none"> De bevoegde installateur is een persoon die door Toshiba Carrier Corporation gemaakte airconditioners installeert, onderhoudt, verplaatst en verwijderd. Hij of zij is opgeleid om door Toshiba Carrier Corporation gemaakte airconditioners te installeren, onderhouden, verplaatsen en te verwijderen. Deze persoon kan ook iemand zijn die in dergelijke taken is geïnstrueerd door een persoon of personen die zijn opgeleid en is dus goed op de hoogte van de kennis voor deze taken. De bevoegde installateur die bevoegd is om het elektrische gedeelte van de installatie, verplaatsing en verwijdering op zich te nemen beschikt over de kwalificaties voor deze elektrische werkzaamheden zoals voorzien in plaatselijke wetten en regelgeving. Deze persoon is opgeleid voor werkzaamheden aan het elektrische systeem van de airconditioners gemaakt door Toshiba Carrier Corporation. Deze persoon kan ook iemand zijn die in dergelijke taken is geïnstrueerd door een persoon of personen die zijn opgeleid en is dus goed op de hoogte van de kennis voor dit soort werk. De bevoegde installateur die bevoegd is om het koel- en leidingenwerk van de installatie, verplaatsing en verwijdering op zich te nemen beschikt over de kwalificaties voor deze koel- en leidingenwerkzaamheden zoals voorzien in plaatselijke wetten en regelgeving. Deze persoon is opgeleid voor koel- en leidingenwerkzaamheden aan de airconditioners gemaakt door Toshiba Carrier Corporation. Deze persoon kan ook iemand zijn die in dergelijke taken is geïnstrueerd door een persoon of personen die zijn opgeleid en is dus goed op de hoogte van de kennis voor dit soort werk. De bevoegde installateur die bevoegd is om op hoogte te werken is opgeleid om op hoogten te werken met airconditioners gemaakt door Toshiba Carrier Corporation. Deze persoon kan ook iemand zijn die in dergelijke taken is geïnstrueerd door een persoon of personen die zijn opgeleid en is dus goed op de hoogte van de kennis voor dit soort werk.
Bevoegd onderhouds-monteur	<ul style="list-style-type: none"> De bevoegde onderhoudspersoon is een persoon die door Toshiba Carrier Corporation gemaakte airconditioners installeert, repareert, onderhoudt, verplaatst en verwijderd. Hij of zij is opgeleid om door Toshiba Carrier Corporation gemaakte airconditioners te installeren, repareren, onderhouden, verplaatsen en te verwijderen. Deze persoon kan ook iemand zijn die in dergelijke taken is geïnstrueerd door een persoon of personen die zijn opgeleid en is dus goed op de hoogte van de kennis voor deze taken. De bevoegde onderhoudspersoon die bevoegd is om het elektrische gedeelte van de installatie, reparatie, verplaatsing en verwijdering op zich te nemen beschikt over de kwalificaties voor deze elektrische werkzaamheden zoals voorzien in plaatselijke wetten en regelgeving. Deze persoon is opgeleid voor werkzaamheden aan het elektrische systeem van de airconditioners gemaakt door Toshiba Carrier Corporation. Deze persoon kan ook iemand zijn die in dergelijke taken is geïnstrueerd door een persoon of personen die zijn opgeleid en is dus goed op de hoogte van de kennis voor dit soort werk. De bevoegde installateur die bevoegd is om het koel- en leidingenwerk van de installatie, reparatie, verplaatsing en verwijdering op zich te nemen beschikt over de kwalificaties voor deze koel- en leidingenwerkzaamheden zoals voorzien in plaatselijke wetten en regelgeving. Deze persoon is opgeleid voor koel- en leidingenwerkzaamheden aan de airconditioners gemaakt door Toshiba Carrier Corporation. Deze persoon kan ook iemand zijn die in dergelijke taken is geïnstrueerd door een persoon of personen die zijn opgeleid en is dus goed op de hoogte van de kennis voor dit soort werk. De bevoegde onderhoudspersoon die bevoegd is om op hoogte te werken is opgeleid om op hoogten te werken met airconditioners gemaakt door Toshiba Carrier Corporation. Deze persoon kan ook iemand zijn die in dergelijke taken is geïnstrueerd door een persoon of personen die zijn opgeleid en is dus goed op de hoogte van de kennis voor dit soort werk.

Definitie van beschermende kleding





Wanneer de airconditioner wordt vervoerd, geïnstalleerd, onderhouden, gerepareerd of verwijderd, draag beschermende handschoenen en veiligheidswerkleding.

Draag naast dergelijke normale beschermende kleding de hieronder beschreven beschermende uitrusting bij het uitvoeren van speciale taken zoals aangegeven in onderstaande tabel.

Niet dragen van de juiste beschermende uitrusting is gevaarlijk omdat u dan meer blootstaat aan letsel, brandwonden, elektrische schokken en andere verwondingen.

Te verrichten werkzaamheden	Beschermende kleding
Alle soorten werk	Werkhandschoenen Veiligheidswerkleding
Elektrische werkzaamheden	Handschoenen die bescherming bieden tegen hitte en elektriciteit Isolerende schoenen Beschermende kleding tegen elektrische schokken
Werk uitgevoerd op hoogte (50 cm of meer)	Veiligheidshelm voor industrieel gebruik
Vervoer van zware voorwerpen	Schoenen met verstevigde neuzen
Reparatie van buiteneenheden	Handschoenen die bescherming bieden tegen hitte en elektriciteit

■ Waarschuwingsaanduidingen op de airconditioner

Waarschuwingsaanduiding	Beschrijving		
 <table border="1"> <tr> <td>WARNING</td> </tr> <tr> <td>ELECTRICAL SHOCK HAZARD Disconnect all remote electric power supplies before servicing.</td> </tr> </table>	WARNING	ELECTRICAL SHOCK HAZARD Disconnect all remote electric power supplies before servicing.	WAARSCHUWING GEVAAR VOOR ELEKTRISCHE SCHOK Verbreek alle externe stroomvoorzieningsaansluitingen alvorens enig onderhoud te verrichten.
WARNING			
ELECTRICAL SHOCK HAZARD Disconnect all remote electric power supplies before servicing.			
 <table border="1"> <tr> <td>WARNING</td> </tr> <tr> <td>Moving parts. Do not operate unit with grille removed. Stop the unit before the servicing.</td> </tr> </table>	WARNING	Moving parts. Do not operate unit with grille removed. Stop the unit before the servicing.	WAARSCHUWING Bewegende delen. Schakel het apparaat niet in wanneer het voorrooster is verwijderd. Stop de werking van het apparaat alvorens enig onderhoud te verrichten.
WARNING			
Moving parts. Do not operate unit with grille removed. Stop the unit before the servicing.			
 <table border="1"> <tr> <td>CAUTION</td> </tr> <tr> <td>High temperature parts. You might get burned when removing this panel.</td> </tr> </table>	CAUTION	High temperature parts. You might get burned when removing this panel.	VOORZICHTIG Delen met hoge temperaturen. Bij het verwijderen van dit paneel is bestaan de kans dat u zich brandt.
CAUTION			
High temperature parts. You might get burned when removing this panel.			
 <table border="1"> <tr> <td>CAUTION</td> </tr> <tr> <td>Do not touch the aluminum fins of the unit. Doing so may result in injury.</td> </tr> </table>	CAUTION	Do not touch the aluminum fins of the unit. Doing so may result in injury.	VOORZICHTIG De aluminium vinnen van de unit niet aanraken. Dat zou tot ernstige verwondingen kunnen leiden.
CAUTION			
Do not touch the aluminum fins of the unit. Doing so may result in injury.			
 <table border="1"> <tr> <td>CAUTION</td> </tr> <tr> <td>BURST HAZARD Open the service valves before the operation, otherwise there might be the burst.</td> </tr> </table>	CAUTION	BURST HAZARD Open the service valves before the operation, otherwise there might be the burst.	VOORZICHTIG GEVAAR VOOR UITBARSTING Open voor enige ingreep eerst de veiligheidskleppen, anders kan er een uitbarsting volgen.
CAUTION			
BURST HAZARD Open the service valves before the operation, otherwise there might be the burst.			

1 Voorzorgen voor de veiligheid

De fabrikant is niet aansprakelijk voor schade ten gevolge van het niet opvolgen van aanwijzingen in deze handleiding.

WAARSCHUWING

Algemeen

- Alvorens u begint met het installeren van de airconditioner, moet u de installatiehandleiding aandachtig doorlezen. Volg beslist alle gegeven aanwijzingen voor het installeren van de airconditioner op.
- Het installeren mag alleen door een gekwalificeerde installateur of onderhoudsmonteur worden uitgevoerd. Een foute installatie resulteert mogelijk in waterlekage, elektrische schokken of brand.
- Gebruik voor het bijvullen of vervangen geen ander koelmiddel dan het gespecificeerde middel. Er wordt anders namelijk mogelijk abnormale hoge druk in de koelcyclus opgebouwd met een onjuiste werking, ontploffing of lichamelijk letsel als gevolg.
- Voordat u het inlaatrooster van de binneneenheid of het onderhoudspaneel van de buiteneenheid opent, zet u eerst de stroomonderbreker in de OFF-stand. Als u verzuimt de stroomonderbreker in de OFF-stand te zetten, loopt u de kans op een elektrische schok bij aanraken van de inwendige onderdelen. Alleen een bevoegd installateur(*1) of een bevoegd onderhoudsmonteur(*1) mag het inlaatrooster van de binneneenheid of het onderhoudspaneel van de buiteneenheid verwijderen en het vereiste werk verrichten.
- Alvorens u begint met installeren, onderhoud, reparaties of het verwijderen, zet u eerst de circuitonderbreker in de OFF-stand. Anders loopt u de kans een elektrische schok te krijgen.
- Plaats een bordje "werk in uitvoering" bij de stroomonderbreker tijdens het installeren, onderhoud, reparatiewerk of werk voor afdanken van het apparaat. Als iemand per vergissing de stroomonderbreker in de ON-stand zet, loopt u de kans een elektrische schok te krijgen.
- Alleen een bevoegd installateur(*1) of een bevoegd onderhoudsmonteur(*1) mag werkzaamheden op hoogte verrichten met een trapje van 50 cm of meer, of het inlaatrooster van de binneneenheid verwijderen om daarbinnen werk te verrichten.
- Draag tijdens het installeren, onderhoud en afdanken van het apparaat altijd werkhandschoenen en veiligheidskleding.
- De aluminium vin van de unit niet aanraken. Anders zou u zich er aan kunnen verwonden. Als het nodig is de koelvin aan te raken, trekt u eerst werkhandschoenen en beschermende kleding aan en begint u dan pas met het werk.
- Plaats nooit voorwerpen op de buiteneenheid en klim er niet bovenop. U zou er af kunnen vallen of een voorwerp kan van de buiteneenheid af vallen en letsel veroorzaken.
- Gebruik voor het werken op hoogte een ladder die voldoet aan de ISO 14122-norm en volg de aanwijzingen in de handleiding van de ladder. Draag tevens een helm voor industrieel gebruik ter bescherming voordat u aan het werk gaat.
- Voor schoonmaken van het filter of andere onderdelen van de buiteneenheid zet u altijd eerst de stroomonderbreker in de OFF-stand en plaatst u een bordje "werk in uitvoering" bij de stroomonderbreker voordat u aan het werk gaat.
- Bij het werken op hoogte dient u voordat u start een waarschuwingsbord te plaatsen zodat niemand uw werkplek te dicht nadert. Anders zouden voorbijgangers gewond kunnen raken door vallende onderdelen en andere voorwerpen. Draag tijdens het uitvoeren een helm ter bescherming tegen mogelijk vallende onderdelen.
- Het koelmiddel dat is toegepast in deze airconditioner is R410A.
- De airconditioner moet stabiel worden getransporteerd. Neem direct contact op met de plaats van aankoop indien onderdelen beschadigd zijn.
- Draag de airconditioner altijd met minimaal 2 personen indien deze met de hand moet worden verplaatst.
- Verplaats of herstel het apparaat niet zelf. De binnenkant van de unit staat onder hoge spanning. U kunt bij het verwijderen van het deksel en de hoofdeunit een elektrische schok krijgen.

Keuze van de installatieplaats

- Indien de airconditioner in een kleine ruimte wordt geplaatst, neem dan maatregelen om te verzekeren dat lekkend koelmiddel in de ruimte niet de limiet kan overschrijden.
- Installeer niet op plaatsen waar ontvlambaar gas kan lekken. Lekkend gas zou namelijk rond de unit op kunnen hopen, worden ontstoken en brand veroorzaken.
- Bij het vervoeren van de airconditioner dient u schoeisel met verstevigde neuzen te dragen.
- Bij het vervoeren van de airconditioner mag u die niet optillen aan de banden rond de verpakkingendoos. Als de banden zouden breken, loopt u de kans op verwondingen.
- Installeer de binneneenheid tenminste 2,5 m boven de vloer, anders zouden gebruikers letsel of een elektrische schok kunnen oplopen als ze hun vingers of iets anders in de binneneenheid steken terwijl de airconditioner werkt.
- Zet geen verbrandingsapparaat op een plaats waar het in de directe luchtstroom van de airconditioner staat, anders kan er onvolledige verbranding plaatsvinden.

Installatie

- Wanneer de binneneenheid moet worden opgehangen, gebruikt u de daarvoor bestemde ophangbouten (M10 of W3/8) en moeren (M10 of W3/8).
- Installeer de airconditioner goed op een plaats die stevig genoeg voor het gewicht van de unit is. Als het ophangpunt niet stevig genoeg is, kan het apparaat vallen, hetgeen letsel kan veroorzaken.

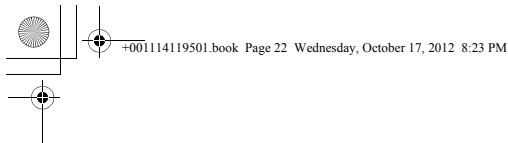

- Bij het installeren van de airconditioner volgt u de aanwijzingen in de installatiehandleiding. De unit zou kunnen vallen, kantelen of extra ruis, trillingen, waterlekage en andere problemen veroorzaken indien u deze aanwijzingen niet opvolgt.
- Voer de vereiste installatie-werkzaamheden uit ter bescherming tegen wind, storm en aardbevingen. De airconditioner kan vallen en ernstige ongelukken veroorzaken indien deze fout is geïnstalleerd.
- Ventileer de ruimte direct indien er tijdens het installeren koelmiddel lekt. Indien lekkend koelmiddel in contact met vuur komt, komt mogelijk giftig gas vrij.
- Gebruik een vorkheftruck voor het verplaatsen van de airconditioner-units en een takel of dergelijk geschikt voorwerp voor het installeren.

Koelmiddelleiding

- Monteer tijdens de installatiewerkzaamheden de koelmiddelleiding nauwkeurig voordat de airconditioner wordt bediend. Als de compressor wordt bediend met de klep open en zonder koelmiddelbuis, zuigt de compressor lucht aan en ontstaat er overdruk in het koelsysteem, hetgeen kan leiden tot verwondingen.
- Draai de flensmoer met een momentsleutel aan op de voorgeschreven manier. Als de flensmoer al te krachtig wordt aangedraaid, kan de moer een tijd later barsten, waardoor koelmiddel kan gaan lekken.
- Controleer na het installeren dat er geen koelmiddel lekt. Wanneer ontsnapt gasvormig koelmiddel in de buurt of in contact komt met open vuur, zoals bij een gasfornuis, kunnen giftige gassen worden gevormd.
- Na het installeren of verplaatsen van de airconditioner volgt u de aanwijzingen in de installatiehandleiding voor het volledig ontluichten van de leidingen, zodat er in het koelsysteem geen ander gas overblijft dan alleen het koelmiddel. Bij onvolledig ontluichten kan de airconditioner niet goed functioneren.
- Gebruik stikstofgas voor de test op luchtdichtheid.
- De oplaadslang moet zo worden aangesloten dat deze niet slap hangt.

Elektrische bedrading

- Alleen een bevoegd installateur(*1) of een bevoegd onderhoudsmonteur(*1) mag elektrische werkzaamheden aan de airconditioner verrichten. Onder geen voorwaarde mag dit werk worden verricht door een onbevoegde, aangezien fouten of vergissingen kunnen leiden tot elektrische schokken en/of kortsluiting of lekstroom.
- Bij het aansluiten van de stroomdraden, het repareren van elektrische onderdelen of het verrichten van andere elektrische werkzaamheden dient u handschoenen ter bescherming tegen hitte en isolerend schoeisel en beschermende kleding ter bescherming tegen elektrische schokken te dragen. Als u dergelijke beschermende kleding niet draagt, loopt u de kans op elektrische schokken.
- Gebruik bedrading die voldoet aan de specificaties in de installatiehandleiding en de ter plaatse geldende voorschriften en wetten. Het gebruik van bedrading die niet voldoet aan de specificaties kan resulteren in elektrische schokken, kortsluiting en lekstroom, rookontwikkeling en/of brandgevaar.
- Verbind een aarddraad. (aardaansluitingen)
Onvolledige aarding kan elektrische schokken veroorzaken.
- Sluit aarddraden niet aan op gasleidingen, waterleidingen, bliksemafleiders of aardkabels voor telefoons.
- Na het voltooiën van de verplaatsing of het reparatiewerk dient u te controleren of de aardleidingen naar behoren zijn aangesloten.
- Installeer een stroomonderbreker die voldoet aan de specificaties in de installatiehandleiding en de ter plaatse geldende voorschriften en wetten.
- Installeer de stroomonderbreker op een plaats waar die goed toegankelijk is voor de gebruiker.
- Als u de stroomonderbreker buitenshuis aanbrengt, let dan goed op dat het een specifiek voor buitengebruik geschikt type is.
- Onder geen voorwaarde mag het netsnoer worden verlengd. Aansluitproblemen op een plaats waar het netsnoer is verlengd kunnen leiden tot rookontwikkeling en/of brandgevaar.
- Werkzaamheden met elektrische bedrading moeten altijd worden uitgevoerd in overeenstemming met de plaatselijke regelgeving, wetten en de installatiehandleiding.
Doet u dit niet, dan kan dat leiden tot elektrocutie of kortsluiting.

Testen

- Nadat u de werkzaamheden hebt voltooid dient u voor het inschakelen van de airconditioner eerst te controleren of het deksel van de elektriciteitskast van de binneneenheid en het onderhoudspaneel van de buiteneenheid zijn gesloten, om vervolgens de stroomonderbreker in de ON-stand te zetten. Als u de stroom inschakelt zonder eerst deze punten te controleren, kunt u een elektrische schok krijgen.
- Indien er iets mis is met de airconditioner (wanneer u een foutmelding ziet of een brandlucht ruikt, vreemde geluiden hoort of wanneer de airconditioner niet koelt of verwarmt, of wanneer er water uit lekt), raak dan de airconditioner niet aan maar zet de circuitonderbreker in de OFF-stand en neem contact op met een bevoegd onderhoudsmonteur. Neem de nodige maatregelen om te voorkomen dat de stroom wordt ingeschakeld (breng bijvoorbeeld een bordje "defect" aan dicht bij de stroomonderbreker) totdat de bevoegde onderhoudsmonteur arriveert. Het voortzetten van het gebruik van de airconditioner terwijl er iets mis mee is, kan leiden tot ernstige mechanische defecten, elektrische schokken en andere problemen.
- Gebruik na beëindiging van het werk een isolatietester (500 V Megger) om te controleren of de weerstand 1 MΩ of meer is tussen het stroomgedeelte en het metalen niet-stroomgedeelte (aardingsgedeelte). Als de weerstandswaarde te gering is, kan er kortsluiting, lekstroom of een elektrische schok optreden aan de gebruikerskant.
- Na voltooiing van het installatiewerk controleert u of er geen koelmiddel lekt, of de waterafvoer in orde is en controleert u de weerstand van de isolatie. Vervolgens laat u de airconditioner proefdraaien, om te zien of het apparaat goed werkt.

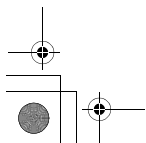

Uitleg aan de gebruiker

- Na voltooiing van het installatiewerk vertelt u de gebruiker waar de stroomonderbreker zich bevindt. Als de gebruiker niet weet waar de stroomonderbreker zit, kan hij of zij de airconditioner niet uitschakelen wanneer er zich een storing voordoet in de werking.
- Indien het ventilatorrooster is beschadigd, raak dan de buitenunit niet aan maar zet de circuitonderbreker in de OFF-stand en verzoek een bevoegd onderhoudsmonteur(*1) om reparatie. Zet de stroomonderbreker niet terug in de ON-stand totdat alle vereiste reparaties zijn voltooid.
- Na voltooiing van het installatiewerk vertelt u aan de hand van de gebruikershandleiding de gebruiker hoe het apparaat te bedienen en te onderhouden.

Elders opstellen

- Alleen een bevoegd installateur(*1) of een bevoegd onderhoudsmonteur(*1) mag de airconditioner verplaatsen. Het is gevaarlijk als een onbevoegde de airconditioner verplaatst, aangezien dat kan leiden tot gevaar voor brand, elektrische schokken, verwondingen, waterlekage, bijgeluiden en/of trillingen.
- Bij uitvoeren van werkzaamheden wanneer de pomp gestopt is, schakelt u eerst de compressor uit voordat u de koelmiddelbuis losmaakt. Wanneer u de koelmiddelleiding loskoppelt met de onderhoudsklep open en de compressor in bedrijf, wordt lucht en gas opgezogen waardoor de druk binnen de koelcyclus te hoog oploopt, wat mogelijk kan leiden tot barsten, letsel of andere problemen.

VOORZICHTIG

Installeren van een airconditioner met een nieuw koelmiddel

- **DEZE AIRCONDITIONER WERKT MET HET NIEUWE HFC-KOELMIDDEL (R410A) DAT DE OZONLAAG NIET AANTAST.**
- Het R410A koelmiddel heeft de volgende karakteristieken: het absorbeert gemakkelijk water, oxidatiemiddel of olie en de druk is ongeveer 1,6 keer hoger dan de druk van R22 koelmiddel. Behalve het nieuwe koelmiddel is ook de koelolie veranderd. Zorg derhalve dat er tijdens het installeren geen water, stof, ander koelmiddel of -olie in de koelcyclus komt.
- Om te voorkomen dat een onjuist koelmiddel en koelolie wordt bijgevuld, is het formaat van de verbindingen en bijvulpoort op de unit en het te gebruiken gereedschap voor het installeren anders dan in geval van het conventionele koelmiddel.
- U heeft derhalve het speciale gereedschap voor het nieuwe koelmiddel (R410A) nodig.
- Gebruik voor het verbinden nieuwe en schone leidingen die voor R410A zijn gefabriceerd zodat er geen water of stof in het systeem kan komen.

Het toestel loskoppelen van de netvoeding.

- Dit toestel moet aangesloten worden op de netvoeding via een schakelaar met een contactafstand van ten minste 3 mm.

De stroomtoevoer van de airconditioner moet voorzien zijn van een installatiezekering (alle types zekeringen kunnen gebruikt worden).

(*1) Zie de "Definitie van een bevoegd installateur of bevoegd onderhoudsmonteur".

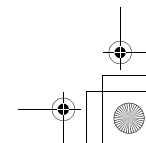
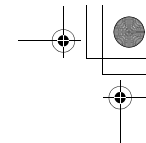

Σας ευχαριστούμε για την αγορά αυτού του κλιματιστικού Toshiba.

Διαβάστε προσεκτικά αυτές τις οδηγίες που περιλαμβάνουν σημαντικές πληροφορίες που συμμορφώνονται με την Οδηγία σχετικά με τα μηχανήματα (Οδηγία 2006/42/ΕΚ) και βεβαιωθείτε ότι τις κατανοείτε.

Μετά την ολοκλήρωση της εργασίας εγκατάστασης, παραδώστε το παρόν Εγχειρίδιο Εγκατάστασης καθώς και το Εγχειρίδιο Κατόχου, το οποίο συνοδεύει την εξωτερική μονάδα, στο χρήστη και υποδείξτε στο χρήστη να το διατηρεί σε ασφαλές σημείο για μελλοντική παραπομπή.

Γενικός χαρακτηρισμός: Κλιματιστική μονάδα

Ορισμός Εξειδικευμένου Εγκαταστάτη ή Εξειδικευμένου Τεχνικού Σέρβις

Απαιτείται εγκατάσταση, συντήρηση, επισκευή και απόρριψη του κλιματιστικού από εξειδικευμένο εγκαταστάτη ή εξειδικευμένο τεχνικό σέρβις. Όταν απαιτείται εκτέλεση οποιασδήποτε από τις συγκεκριμένες εργασίες, αναθέστε την εκτέλεσή της σε εξειδικευμένο εγκαταστάτη ή εξειδικευμένο τεχνικό σέρβις.

Ένας εξειδικευμένος εγκαταστάτης ή εξειδικευμένος τεχνικός σέρβις είναι αντιπρόσωπος ο οποίος διαθέτει τα προσόντα και τις γνώσεις που περιγράφονται στον πίνακα κατωτέρω.

Αντιπρόσωπος	Προσόντα και γνώσεις τα οποία απαιτείται να διαθέτει ο αντιπρόσωπος
Εξειδικευμένος εγκαταστάτης	<ul style="list-style-type: none"> Ο εξειδικευμένος εγκαταστάτης είναι ένα άτομο που πραγματοποιεί εργασίες εγκατάστασης, συντήρησης, αλλαγής θέσης και αφαίρεσης των κλιματιστικών που κατασκευάζει η Toshiba Carrier Corporation. Το άτομο αυτό έχει εκπαιδευτεί στην εγκατάσταση, συντήρηση, αλλαγή θέσης και αφαίρεση των κλιματιστικών που κατασκευάζει η Toshiba Carrier Corporation ή, εναλλακτικά, έχει διδαχθεί αυτές τις εργασίες από άτομα που έχουν εκπαιδευτεί και είναι επομένως πλήρως εξοικειωμένοι με τις γνώσεις που σχετίζονται με αυτές τις εργασίες. Ο εξειδικευμένος εγκαταστάτης που επιτρέπεται να κάνει τις ηλεκτρικές εργασίες που σχετίζονται με την εγκατάσταση, αλλαγή θέσης και αφαίρεση, διαθέτει τα προσόντα που σχετίζονται με αυτές τις ηλεκτρικές εργασίες όπως ορίζεται από τους τοπικούς νόμους και κανονισμούς, και είναι άτομο που έχει εκπαιδευτεί σε θέματα που σχετίζονται με τις ηλεκτρικές εργασίες σε κλιματιστικά που κατασκευάζονται από την Toshiba Carrier Corporation ή, εναλλακτικά, έχει διδαχθεί αυτές τις εργασίες από άτομα που έχουν εκπαιδευτεί και, επομένως, είναι πλήρως εξοικειωμένοι με τις γνώσεις που σχετίζονται με αυτές τις εργασίες. Ο εξειδικευμένος εγκαταστάτης που επιτρέπεται να χειρίζεται το ψυκτικό και να εκτελεί τις εργασίες σωλήνωσης που σχετίζονται με την εγκατάσταση, αλλαγή θέσης και αφαίρεση, διαθέτει τα προσόντα που σχετίζονται με αυτές τις εργασίες χειρισμού του ψυκτικού και τις εργασίες σωλήνωσης όπως ορίζεται από τους τοπικούς νόμους και κανονισμούς, και είναι άτομο που έχει εκπαιδευτεί σε θέματα που σχετίζονται με τις εργασίες χειρισμού του ψυκτικού και τις εργασίες σωλήνωσης σε κλιματιστικά που κατασκευάζονται από την Toshiba Carrier Corporation ή, εναλλακτικά, έχει διδαχθεί αυτές τις εργασίες από άτομα που έχουν εκπαιδευτεί και, επομένως, είναι πλήρως εξοικειωμένοι με τις γνώσεις που σχετίζονται με αυτές τις εργασίες. Ο εξειδικευμένος εγκαταστάτης που επιτρέπεται να εργάζεται σε ύψη έχει εκπαιδευτεί σε θέματα που σχετίζονται με τις εργασίες σε ύψη με κλιματιστικά που κατασκευάζονται από την Toshiba Carrier Corporation ή, εναλλακτικά, έχει διδαχθεί αυτές τις εργασίες από άτομα που έχουν εκπαιδευτεί και, επομένως, είναι πλήρως εξοικειωμένοι με τις γνώσεις που σχετίζονται με αυτές τις εργασίες.
Εξειδικευμένος τεχνικός σέρβις	<ul style="list-style-type: none"> Ο εξειδικευμένος τεχνικός επισκευών είναι ένα άτομο που πραγματοποιεί εργασίες εγκατάστασης, επισκευής, συντήρησης, αλλαγής θέσης και αφαίρεσης των κλιματιστικών που κατασκευάζει η Toshiba Carrier Corporation. Το άτομο αυτό έχει εκπαιδευτεί στην εγκατάσταση, επισκευή, συντήρηση, αλλαγή θέσης και αφαίρεση των κλιματιστικών που κατασκευάζει η Toshiba Carrier Corporation ή, εναλλακτικά, έχει διδαχθεί αυτές τις εργασίες από άτομα που έχουν εκπαιδευτεί και είναι επομένως πλήρως εξοικειωμένοι με τις γνώσεις που σχετίζονται με αυτές τις εργασίες. Ο εξειδικευμένος τεχνικός επισκευών που επιτρέπεται να κάνει τις ηλεκτρικές εργασίες που σχετίζονται με την εγκατάσταση, επισκευή, αλλαγή θέσης και αφαίρεση, διαθέτει τα προσόντα που σχετίζονται με αυτές τις ηλεκτρικές εργασίες όπως ορίζεται από τους τοπικούς νόμους και κανονισμούς, και είναι άτομο που έχει εκπαιδευτεί σε θέματα που σχετίζονται με τις ηλεκτρικές εργασίες σε κλιματιστικά που κατασκευάζονται από την Toshiba Carrier Corporation ή, εναλλακτικά, έχει διδαχθεί αυτές τις εργασίες από άτομα που έχουν εκπαιδευτεί και, επομένως, είναι πλήρως εξοικειωμένοι με τις γνώσεις που σχετίζονται με αυτές τις εργασίες. Ο εξειδικευμένος τεχνικός επισκευών που επιτρέπεται να χειρίζεται το ψυκτικό και να εκτελεί τις εργασίες σωλήνωσης που σχετίζονται με την εγκατάσταση, επισκευή, αλλαγή θέσης και αφαίρεση, διαθέτει τα προσόντα που σχετίζονται με αυτές τις εργασίες χειρισμού του ψυκτικού και τις εργασίες σωλήνωσης όπως ορίζεται από τους τοπικούς νόμους και κανονισμούς, και είναι άτομο που έχει εκπαιδευτεί σε θέματα που σχετίζονται με τις εργασίες χειρισμού του ψυκτικού και τις εργασίες σωλήνωσης σε κλιματιστικά που κατασκευάζονται από την Toshiba Carrier Corporation ή, εναλλακτικά, έχει διδαχθεί αυτές τις εργασίες από άτομα που έχουν εκπαιδευτεί και, επομένως, είναι πλήρως εξοικειωμένοι με τις γνώσεις που σχετίζονται με αυτές τις εργασίες. Ο εξειδικευμένος τεχνικός επισκευών που επιτρέπεται να εργάζεται σε ύψη έχει εκπαιδευτεί σε θέματα που σχετίζονται με τις εργασίες σε ύψη με κλιματιστικά που κατασκευάζονται από την Toshiba Carrier Corporation ή, εναλλακτικά, έχει διδαχθεί αυτές τις εργασίες από άτομα που έχουν εκπαιδευτεί και, επομένως, είναι πλήρως εξοικειωμένοι με τις γνώσεις που σχετίζονται με αυτές τις εργασίες.

Ορισμός εξοπλισμού προστασίας





Όταν πραγματοποιείται μεταφορά, εγκατάσταση, συντήρηση, επισκευή ή αφαίρεση του κλιματιστικού, να φοράτε προστατευτικά γάντια και ρουχισμό εργασίας 'ασφαλείας'.

Εκτός από τον συνηθισμένο προστατευτικό εξοπλισμό, να φοράτε τον προστατευτικό εξοπλισμό που περιγράφεται παρακάτω κατά την εκτέλεση των ειδικών εργασιών που περιγράφονται στον παρακάτω πίνακα.

Αν παραλείψετε να φορέσετε το σωστό προστατευτικό εξοπλισμό, θέτετε τον εαυτό σας σε κίνδυνο καθώς θα είστε πιο ευάλωτοι σε τραυματισμούς, εγκαύματα, ηλεκτροπληξίες και άλλους τραυματισμούς.

Εκτελούμενη εργασία	Χρήση εξοπλισμού προστασίας
Κάθε τύπος εργασίας	Γάντια προστασίας Ρουχισμός εργασίας 'ασφαλείας'
Ηλεκτρολογικές εργασίες	Γάντια προστασίας από ηλεκτροπληξία και θερμότητα Μονωμένα παπούτσια Ρουχισμός που παρέχει προστασία από ηλεκτροπληξία
Εργασία σε ύψη (50 cm ή περισσότερο)	Κράνη βιομηχανικής χρήσης
Μεταφορά βάρων αντικειμένων	Υποδήματα με πρόσθετη προστασία των άκρων των ποδιών
Επισκευή εξωτερικής μονάδας	Γάντια προστασίας από ηλεκτροπληξία και θερμότητα

■ Προειδοποιητικές ενδείξεις στην κλιματιστική μονάδα

Προειδοποιητική ένδειξη	Περιγραφή		
 <table border="1"> <tr> <td>WARNING</td> </tr> <tr> <td>ELECTRICAL SHOCK HAZARD Disconnect all remote electric power supplies before servicing.</td> </tr> </table>	WARNING	ELECTRICAL SHOCK HAZARD Disconnect all remote electric power supplies before servicing.	ΠΡΟΕΙΔΟΠΟΙΗΣΗ ΚΙΝΔΥΝΟΣ ΗΛΕΚΤΡΟΠΛΗΞΙΑΣ Αποσυνδέστε όλες τις απομακρυσμένες παροχές ηλεκτρικής τροφοδοσίας πριν από τη διενέργεια σέρβις.
WARNING			
ELECTRICAL SHOCK HAZARD Disconnect all remote electric power supplies before servicing.			
 <table border="1"> <tr> <td>WARNING</td> </tr> <tr> <td>Moving parts. Do not operate unit with grille removed. Stop the unit before the servicing.</td> </tr> </table>	WARNING	Moving parts. Do not operate unit with grille removed. Stop the unit before the servicing.	ΠΡΟΕΙΔΟΠΟΙΗΣΗ Κινούμενα μέρη. Μην θέσετε τη μονάδα σε λειτουργία, εάν έχετε αφαιρέσει τη γρίλια. Διακόψτε τη λειτουργία της μονάδας πριν από τη διενέργεια σέρβις.
WARNING			
Moving parts. Do not operate unit with grille removed. Stop the unit before the servicing.			
 <table border="1"> <tr> <td>CAUTION</td> </tr> <tr> <td>High temperature parts. You might get burned when removing this panel.</td> </tr> </table>	CAUTION	High temperature parts. You might get burned when removing this panel.	ΠΡΟΣΟΧΗ Μέρη με υψηλή θερμοκρασία. Ενδέχεται να υποστείτε έγκαυμα κατά την αφαίρεση αυτού του πίνακα.
CAUTION			
High temperature parts. You might get burned when removing this panel.			
 <table border="1"> <tr> <td>CAUTION</td> </tr> <tr> <td>Do not touch the aluminum fins of the unit. Doing so may result in injury.</td> </tr> </table>	CAUTION	Do not touch the aluminum fins of the unit. Doing so may result in injury.	ΠΡΟΣΟΧΗ Μην ακουμπάτε τα πτερύγια αλουμινίου της μονάδας. Η μη συμμόρφωση ενδέχεται να προκαλέσει τραυματισμό.
CAUTION			
Do not touch the aluminum fins of the unit. Doing so may result in injury.			
 <table border="1"> <tr> <td>CAUTION</td> </tr> <tr> <td>BURST HAZARD Open the service valves before the operation, otherwise there might be the burst.</td> </tr> </table>	CAUTION	BURST HAZARD Open the service valves before the operation, otherwise there might be the burst.	ΠΡΟΣΟΧΗ ΚΙΝΔΥΝΟΣ ΕΚΡΗΞΗΣ Ανοίξτε τις βαλβίδες σέρβις πριν από τη λειτουργία, διαφορετικά ενδέχεται να προκληθεί έκρηξη.
CAUTION			
BURST HAZARD Open the service valves before the operation, otherwise there might be the burst.			

1 Προφυλάξεις για ασφάλεια

Ο κατασκευαστής δεν αναλαμβάνει ευθύνη για τυχόν βλάβες ή/και προκλήθουν από αμέλεια συμμόρφωσης με τα όσα περιγράφονται στο παρόν εγχειρίδιο.

ΠΡΟΕΙΔΟΠΟΙΗΣΗ

Γενικά

- Πριν ξεκινήσετε με την εγκατάσταση του κλιματιστικού, διαβάστε με προσοχή το Εγχειρίδιο εγκατάστασης και ακολουθήστε τις οδηγίες για την εγκατάσταση του κλιματιστικού.
- Οι εργασίες εγκατάστασης επιτρέπεται να πραγματοποιηθούν μόνο από εξειδικευμένο εγκαταστάτη ή εξειδικευμένο τεχνικό σέρβις. Η λανθασμένη εγκατάσταση μπορεί να οδηγήσει σε διαρροές νερού, ηλεκτροπληξία ή πυρκαγιά.
- Μην χρησιμοποιείτε ψυκτικό άλλο από το προβλεπόμενο, για συμπλήρωση ή αντικατάσταση. Διαφορετικά, ενδέχεται να αναπτυχθεί αντικανονικά υψηλή πίεση στον ψυκτικό κύκλο, κάτι που ενδέχεται να επιφέρει βλάβη του προϊόντος ή έκρηξη ή σωματικό τραυματισμό σας.
- Πριν ανοίξετε τη γρίλια εισαγωγής της εσωτερικής μονάδας ή του πίνακα σέρβις της εξωτερικής μονάδας, θέστε τον αυτόματο διακόπτη κυκλώματος στη θέση OFF. Εάν δεν θέσετε τον αυτόματο διακόπτη κυκλώματος στη θέση OFF ενδέχεται να προκληθεί ηλεκτροπληξία λόγω τυχαίας επαφής με τα εξαρτήματα στο εσωτερικό της μονάδας. Η αφαίρεση της γρίλιας εισαγωγής της εσωτερικής μονάδας ή του πίνακα σέρβις της εξωτερικής μονάδας και η εκτέλεση των απαιτούμενων εργασιών, επιτρέπεται μόνον από εξειδικευμένο εγκαταστάτη(*1) ή εξειδικευμένο τεχνικό σέρβις(*1).
- Πριν από την εκτέλεση εργασιών εγκατάστασης, συντήρησης, επισκευών ή αφαίρεσης, θέστε τον αυτόματο διακόπτη κυκλώματος στη θέση OFF. Διαφορετικά, ενδέχεται να προκληθεί ηλεκτροπληξία.
- Αναρτήστε πινακίδα με την ένδειξη "Εκτελούνται εργασίες" κοντά στον αυτόματο διακόπτη κυκλώματος ενόσω εκτελούνται εργασίες εγκατάστασης, συντήρησης, επισκευής ή απόρριψης. Υπάρχει κίνδυνος πρόκλησης ηλεκτροπληξίας, εάν ο αυτόματος διακόπτης κυκλώματος τεθεί στη θέση ON τυχαία.
- Μόνον εξειδικευμένος εγκαταστάτης(*1) ή εξειδικευμένος τεχνικός σέρβις(*1) επιτρέπεται να αναλαμβάνει την εκτέλεση εργασιών σε υψηλά σημεία χρησιμοποιώντας βάση ύψους 50 cm ή υψηλότερη ή να αφαιρεί τη γρίλια εισαγωγής της εσωτερικής μονάδας για την εκτέλεση εργασιών.
- Να φοράτε γάντια προστασίας και ρουχισμό για την ασφάλεια κατά την εργασία, όταν εκτελείτε εργασίες εγκατάστασης, σέρβις και απόρριψης.
- Μην αγγίζετε τα αλουμινένια πτερύγια της μονάδας. Ενδέχεται να τραυματιστείτε εάν το πράξετε. Εάν απαιτείται να αγγίξετε το πτερύγιο για οποιοδήποτε λόγο, φορέστε πρώτα γάντια προστασίας και ρουχισμό για την ασφάλεια κατά την εργασία και τότε μόνον προχωρήστε.
- Μην ανεβαίνετε πάνω στην εξωτερική μονάδα και μην τοποθετείτε αντικείμενα πάνω σε αυτήν. Ενδέχεται να πέσετε εσείς ή τα αντικείμενα και να προκληθεί τραυματισμός.
- Όταν εκτελείτε εργασία σε ύψος, χρησιμοποιείστε σκάλα σύμφωνη με το πρότυπο ISO 14122, και ακολουθήστε τη διαδικασία η οποία αναφέρεται στις οδηγίες της σκάλας. Να φοράτε επίσης, κράνος βιομηχανικής χρήσης ως εξοπλισμό προστασίας πριν από την εκτέλεση της εργασίας.
- Πριν από τον καθαρισμό του φίλτρου ή άλλων μερών της εξωτερικής μονάδας, τοποθετήστε οπωσδήποτε τον αυτόματο διακόπτη στο OFF, και τοποθετήστε μία πινακίδα "Εκτελούνται εργασίες" κοντά στον αυτόματο διακόπτη προτού προχωρήσετε με την εργασία.
- Πριν από εργασία σε μεγάλο ύψος, τοποθετήστε μία πινακίδα έτσι ώστε κανείς να μην πλησιάσει το χώρο εργασίας, προτού προχωρήσετε με την εργασία σας. Εξαρτήματα και άλλα αντικείμενα ενδέχεται να υποστούν πτώση, τραυματίζοντας ενδεχομένως κάποιο άτομο το οποίο βρίσκεται από κάτω. Κατά την εκτέλεση των εργασιών, να φοράτε κράνος για την προστασία σας έναντι πτώσης αντικειμένων.
- Το ψυκτικό υγρό το οποίο χρησιμοποιείται στο συγκεκριμένο κλιματιστικό είναι τύπου R410A.
- Το κλιματιστικό μηχανήμα θα πρέπει να μεταφέρεται σε συνθήκες ευστάθειας. Εάν οποιοδήποτε κομμάτι του προϊόντος είναι σπασμένο, επικοινωνήστε με τον αντιπρόσωπο.
- Όταν είναι απαραίτητο να μεταφερθεί με τα χέρια, θα πρέπει να το μεταφέρουν δύο ή περισσότερα άτομα.
- Μη μετακινείτε ή επισκευάζετε οποιαδήποτε μονάδα μόνον σας. Υπάρχει υψηλή τάση στο εσωτερικό της μονάδας. Μπορεί να σας προκαλέσει ηλεκτροπληξία όταν αφαιρέσετε το κάλυμμα και την κεντρική μονάδα.

Επιλογή θέσης εγκατάστασης

- Όταν το κλιματιστικό είναι τοποθετημένο σε μικρό δωμάτιο, λάβετε τα κατάλληλα μέτρα προκειμένου να εξασφαλιστεί ότι η συγκέντρωση διαρροής ψυκτικού στο δωμάτιο δεν υπερβαίνει το κρίσιμο επίπεδο.
- Μην τοποθετείτε το μηχανήμα σε χώρο όπου υπάρχει πιθανότητα διαρροών εύφλεκτων αερίων. Εάν διαρρέει αέριο το οποίο και συσσωρεύεται γύρω από τη μονάδα, υπάρχει κίνδυνος να αναφλεγεί και να προκληθεί πυρκαγιά.
- Για να μεταφέρετε το κλιματιστικό μηχανήμα, να φοράτε υποδήματα με μεταλλικά καλύμματα στις μύτες.
- Για να μεταφέρετε το κλιματιστικό μηχανήμα, μην το κρατάτε από τα τέρκρια που υπάρχουν γύρω από το χαρτοκιβώτιο της συσκευασίας του. Ενδέχεται να τραυματιστείτε, εάν οι ταινίες σπάσουν.
- Εγκαταστήστε την εσωτερική μονάδα σε ύψος 2,5 m τουλάχιστον πάνω από το δάπεδο, διότι διαφορετικά οι χρήστες ενδέχεται να τραυματιστούν ή να υποστούν ηλεκτροπληξία σε περίπτωση που εισάγουν τα δάκτυλά τους ή άλλα αντικείμενα στο εσωτερικό της εσωτερικής μονάδας ενώ το κλιματιστικό βρίσκεται σε λειτουργία.

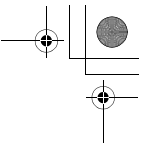

- Μην τοποθετείτε συσκευή καύσης σε σημείο το οποίο εκτίθεται απευθείας στη ροή αέρα του κλιματιστικού, ενδέχεται να προκληθεί ατελής καύση.

Εγκατάσταση

- Όταν η εσωτερική μονάδα προορίζεται για ανάρτηση, απαιτείται η χρήση των κοχλιών ανάρτησης (M10 ή W3/8) και των περικοχλιών (M10 ή W3/8) αποκλειστικής χρήσης.
- Εγκαταστήστε το κλιματιστικό μηχανήμα με ασφάλεια, σε σημείο όπου η βάση του να μπορεί να στηρίξει επαρκώς το βάρος του. Εάν τα σημεία αυτά δεν διαθέτουν επαρκή αντοχή, η μονάδα ενδέχεται να υποστεί πτώση και να προκαλέσει τραυματισμό.
- Ακολουθήστε τις οδηγίες που αναγράφονται στο Εγχειρίδιο Εγκατάστασης για να εγκαταστήσετε το κλιματιστικό. Αμέλεια συμμόρφωσης με αυτές τις οδηγίες μπορεί να προκαλέσει πτώση ή ανατροπή του προϊόντος ή να αναπτύσσονται θόρυβος, κραδασμοί, διαρροή νερού ή άλλα προβλήματα.
- Πραγματοποιήστε την προβλεπόμενη εργασία εγκατάστασης έτσι ώστε ο εξοπλισμός να αντέχει σε πιθανούς ισχυρούς ανέμους ή σεισμό. Εάν το κλιματιστικό μηχανήμα δεν εγκατασταθεί σωστά, μπορεί κάποια μονάδα να ανατραπεί ή να πέσει από ύψος, με αποτέλεσμα την πρόκληση ατυχήματος.
- Σε περίπτωση διαρροής του ψυκτικού αερίου κατά τη διάρκεια των εργασιών εγκατάστασης, αερίστε τον χώρο αμέσως. Εάν το ψυκτικό αέριο που διαρρέει έρθει σε επαφή με φωτιά, υπάρχει η πιθανότητα έκλυσης δύσσομου αερίου.
- Χρησιμοποιήστε περνοφόρο ανυψωτικό μηχανήμα για να μεταφέρετε τα τμήματα του κλιματιστικού μηχανήματος και χρησιμοποιήστε βαρούλκο ή παλάγκο για την εγκατάστασή τους.

Σωλήνωση ψυκτικού

- Εγκαταστήστε το σωλήνα ψυκτικού με ασφάλεια στη διάρκεια της εργασίας εγκατάστασης πριν θέσετε σε λειτουργία το κλιματιστικό. Εάν ο συμπιεστής λειτουργήσει με τη βαλβίδα ανοιχτή και χωρίς σωλήνα ψυκτικού υγρού, ο συμπιεστής αναρροφά αέρα και ο κύκλος ψύξης υπερσυμπιέζεται, πράγμα το οποίο ενδέχεται να προκαλέσει τραυματισμό.
- Σφίξτε το ρακόρ με ένα ροτόκλειδο ακολουθώντας τον καθορισμένο τρόπο. Τυχόν υπερβολικό σφίξιμο του ρακόρ ενδέχεται να προκαλέσει ράγιγμα του ρακόρ μετά από μακρό χρονικό διάστημα, πράγμα το οποίο ενδέχεται να καταλήξει σε διαρροή ψυκτικού υγρού.
- Μετά τις εργασίες εγκατάστασης, βεβαιωθείτε ότι δεν υπάρχει διαρροή του ψυκτικού αερίου. Τυχόν διαρροή του ψυκτικού αερίου στο χώρο και κίνησή του κοντά σε πηγή φωτιάς, όπως εστία κουζίνας, ενδέχεται να δημιουργήσει επιβλαβείς αναθυμιάσεις.
- Μόλις ολοκληρωθεί η εγκατάσταση ή η αλλαγή θέσης του κλιματιστικού, ακολουθήστε τις οδηγίες που αναγράφονται στο Εγχειρίδιο Εγκατάστασης για πλήρη εξαέρωση, ώστε στον κύκλο ψύξης να μην αναμιγνύονται άλλα αέρια εκτός του ψυκτικού υγρού. Εάν δεν πραγματοποιήσετε πλήρη εξαέρωση, ενδέχεται να προκληθεί δυσλειτουργία του κλιματιστικού.
- Απαιτείται η χρήση αερίου αζώτου για τη δοκιμή στεγανότητας.
- Ο σωλήνας πλήρωσης πρέπει να συνδεθεί με τρόπο ώστε να μην παρουσιάζει χαλαρότητα.

Ηλεκτρική καλωδίωση

- Η εκτέλεση των ηλεκτρολογικών εργασιών στο κλιματιστικό επιτρέπεται μόνον από εξειδικευμένο εγκαταστάτη(*1) ή εξειδικευμένο τεχνικό σέρβις(*1). Σε καμία περίπτωση δεν επιτρέπεται η εκτέλεση των εν λόγω εργασιών από ανειδίκευτο άτομο, επειδή τυχόν μη κατάλληλη εκτέλεση των εργασιών ενδέχεται να καταλήξει σε ηλεκτροπληξία ή/και διαρροές ρεύματος.
- Για να συνδέσετε τα καλώδια ρεύματος, την επισκευή ηλεκτρολογικών μερών ή άλλες εργασίες ηλεκτρολογικής φύσης, να φοράτε μονωτικά γάντια (ηλεκτρολόγου) και προστασίας από τη θερμότητα, μονωτικά υποδήματα και ενδυμασία για προστασία έναντι ηλεκτροπληξίας. Η μη χρήση του συγκεκριμένου εξοπλισμού προστασίας ενδέχεται να καταλήξει σε ηλεκτροπληξία.
- Να χρησιμοποιείτε καλωδιώσεις οι οποίες πληρούν τις προδιαγραφές του Εγχειριδίου Εγκατάστασης και τις απαιτήσεις των τοπικών κανονισμών και νομοθεσίας. Η χρήση καλωδιώσεων οι οποίες δεν πληρούν τις προδιαγραφές ενδέχεται να προκαλέσει ηλεκτροπληξία, διαρροές ρεύματος, καπνό ή/και πυρκαγιά.
- Συνδέστε το καλώδιο γείωσης. (εργασία γείωσης)
Η ελλιπής γείωση θα προκαλέσει ηλεκτροπληξία.
- Μη συνδέετε τα καλώδια γείωσης με σωλήνες φυσικού αερίου, σωλήνες νερού και την κάθοδο του αντικεραυνικού συστήματος ή τους αγωγούς γείωσης του τηλεφώνου.
- Μετά την ολοκλήρωση της εργασίας επισκευής ή μετεγκατάστασης, βεβαιωθείτε ότι οι αγωγοί γείωσης έχουν συνδεθεί σωστά.
- Φροντίστε για την εγκατάσταση αυτόματου διακόπτη κυκλώματος ο οποίος πληροί τις προδιαγραφές του Εγχειριδίου Εγκατάστασης και τις απαιτήσεις των τοπικών κανονισμών και νομοθεσίας.
- Εγκαταστήστε τον αυτόματο διακόπτη κυκλώματος σε σημείο όπου θα διευκολύνεται η πρόσβασή του από τον αντιπρόσωπο.
- Όταν πραγματοποιείτε εγκατάσταση του αυτόματου διακόπτη κυκλώματος σε εξωτερικό χώρο, φροντίστε για την εγκατάσταση διακόπτη κατάλληλου τύπου για εξωτερική χρήση.
- Σε καμία περίπτωση δεν πρέπει να κάνετε προέκταση του καλωδίου ρεύματος. Τυχόν ελαττωματική σύνδεση στα σημεία προέκτασης των αγωγών μπορεί να προκαλέσει καπνό και/ή πυρκαγιά.
- Οι εργασίες ηλεκτρικής καλωδίωσης πρέπει να εκτελούνται σύμφωνα με τους νόμους και κανονισμούς της κοινότητας και το εγχειρίδιο εγκατάστασης.

Διαφορετικά μπορεί να προκληθεί ηλεκτροπληξία ή βραχυκύκλωμα.

Δοκιμαστική λειτουργία

- Μόλις ολοκληρωθούν οι εργασίες και πριν θέσετε το κλιματιστικό σε λειτουργία, βεβαιωθείτε ότι το κάλυμμα του κιβωτίου ηλεκτρικών εξαρτημάτων της εσωτερικής μονάδας και ο πίνακας σέρβις της εξωτερικής μονάδας είναι κλειστά και θέστε τον αυτόματο διακόπτη κυκλώματος στη θέση ON. Εάν δεν πραγματοποιήσετε αυτούς τους ελέγχους, ενδέχεται να υποστείτε ηλεκτροπληξία σε περίπτωση που ενεργοποιηθεί η τροφοδοσία.

- Εάν παρουσιαστεί κάποιο πρόβλημα στο κλιματιστικό μηχανήμα (όπως εμφάνιση ένδειξης σφάλματος, οσμή καμένου, ασυνήθιστοι θόρυβοι, το κλιματιστικό μηχανήμα δεν ψύχει ή δε θερμαίνει ή υπάρχει διαρροή νερού), μην αγγίζετε το ίδιο το κλιματιστικό μηχανήμα αλλά κλείστε τον αυτόματο διακόπτη (στο OFF) και επικοινωνήστε με εξειδικευμένο τεχνικό. Λάβετε μέτρα, ώστε να μην είναι επικίνδυνη η ενεργοποίηση της παροχής ρεύματος (αναρτώντας μια πινακίδα με την ένδειξη "εκτός λειτουργίας" κοντά στον αυτόματο διακόπτη κυκλώματος, για παράδειγμα), έως ότου να φθάσει ο εξειδικευμένος τεχνικός σέρβις. Εάν συνεχίζετε να χρησιμοποιείτε το κλιματιστικό μηχανήμα παρόλο που παρουσιάζει πρόβλημα, ενδέχεται τα μηχανικά προβλήματά του να επιδεινωθούν ή να προκληθεί ηλεκτροπληξία κλπ.
- Μετά την ολοκλήρωση της εργασίας, χρησιμοποιήστε δοκιμαστικό όργανο μόνωσης (500 V Megger) για να βεβαιωθείτε ότι η αντίσταση είναι 1 MW ή περισσότερο μεταξύ του φορτισμένου τμήματος και του μεταλλικού τμήματος που δε βρίσκεται υπό φορτίο (του γειωμένου τμήματος). Εάν η τιμή αντίστασης είναι χαμηλή, θα προκληθεί σοβαρή ζημία στην πλευρά του χρήστη, όπως διαρροή ρεύματος ή ηλεκτροπληξία.
- Μόλις ολοκληρωθούν οι εργασίες εγκατάστασης, ελέγξτε για διαρροές ψυκτικού υγρού, την αντίσταση μόνωσης και την αποστράγγιση νερού. Στη συνέχεια, εκτελέστε δοκιμαστική λειτουργία ώστε να ελεγχθεί ότι το κλιματιστικό λειτουργεί κανονικά.

Επεξηγήσεις που παρέχονται στο χρήστη

- Μόλις ολοκληρωθούν οι εργασίες εγκατάστασης, ενημερώστε το χρήστη για τη θέση του αυτόματου διακόπτη κυκλώματος. Εάν ο χρήστης δεν γνωρίζει που βρίσκεται ο αυτόματος διακόπτης κυκλώματος, δεν θα μπορεί να τον απενεργοποιήσει σε περίπτωση που παρουσιαστεί κάποιο πρόβλημα στο κλιματιστικό.
- Εάν υπάρχει βλάβη στη σχάρα του ανεμιστήρα, μην πλησιάζετε στην εξωτερική μονάδα. Βάλτε τον αυτόματο διακόπτη στο OFF και επικοινωνήστε με εξειδικευμένο τεχνικό(*1) για την επισκευή του μηχανήματος. Μην θέσετε τον αυτόματο διακόπτη κυκλώματος στη θέση ON, εάν δεν ολοκληρωθούν οι επισκευές.
- Μόλις ολοκληρωθούν οι εργασίες εγκατάστασης, ακολουθήστε τις οδηγίες που αναγράφονται στο εγχειρίδιο κατόχου, για να εξηγήσετε στον πελάτη τον τρόπο χρήσης και συντήρησης της μονάδας.

Αλλαγή θέσης

- Η μεταφορά του κλιματιστικού σε άλλη θέση επιτρέπεται μόνον από εξειδικευμένο εγκαταστάτη(*1) ή εξειδικευμένο τεχνικό σέρβις(*1). Σε περίπτωση εγκατάστασης του κλιματιστικού από ανειδίκευτο άτομο, υπάρχει μεγάλος κίνδυνος να προκληθεί πυρκαγιά, ηλεκτροπληξία, τραυματισμός, διαρροή νερού, θόρυβος ή/και κραδασμοί.
- Κατά την εργασία περισυλλογής ψυκτικού υγρού, διακόψτε τη λειτουργία του συμπιεστή πριν από την αποσύνδεση του σωλήνα ψυκτικού υγρού. Η αποσύνδεση του σωλήνα ψυκτικού ενώ η βαλβίδα συντήρησης είναι ανοικτή και ο συμπιεστής λειτουργεί, θα προκαλέσει την αναρρόφηση αέρα ή άλλου αερίου, την αύξηση της πίεσης στο εσωτερικό του κύκλου ψύξης σε μη φυσιολογικά υψηλά επίπεδα και μπορεί πιθανώς να προκληθεί ρήξη, τραυματισμός ή άλλη βλάβη.

ΠΡΟΣΟΧΗ

Εγκατάσταση κλιματιστικού με νέο ψυκτικό

- ΤΟ ΠΑΡΟΝ ΚΛΙΜΑΤΙΣΤΙΚΟ ΥΙΟΘΕΤΕΙ ΕΝΑ ΝΕΟΥ ΤΥΠΟΥ ΨΥΚΤΙΚΟ ΥΔΡΟΦΘΟΡΙΟΑΝΘΡΑΚΑ (R410A) ΠΟΥ ΔΕΝ ΚΑΤΑΣΤΡΕΦΕΙ ΤΗ ΣΤΙΒΑΔΑ ΤΟΥ ΟΖΟΝΤΟΣ.**
- Τα χαρακτηριστικά του ψυκτικού R410A είναι: ευκολία απορρόφησης νερού, οξειδωτικής μεμβράνης ή ελαίων και η πίεσή του είναι περίπου 1,6 φορές μεγαλύτερη από αυτήν του ψυκτικού R22. Όταν συνοδεύεται με το νέο ψυκτικό, το λάδι ψύξης έχει αλλάξει ήδη. Κατά συνέπεια, εμποδίστε την είσοδο νερού, σκόνης, χρησιμοποιημένου ψυκτικού, ή ψυκτικού ελαίου στον ψυκτικό κύκλο κατά την εργασία εγκατάστασης.
- Για την αποφυγή πλήρωσης εσφαλμένου ψυκτικού και λαδιού ψύξης, το μέγεθος του ανοίγματος σύνδεσης στη θύρα πλήρωσης της κύριας μονάδας και τα εργαλεία εγκατάστασης έχουν αλλάξει σε σύγκριση με το συμβατικό ψυκτικό.
- Αντίστοιχα, απαιτούνται αποκλειστικά εργαλεία για το νέο ψυκτικό (R410A).
- Για τους σωλήνες σύνδεσης, χρησιμοποιήστε καινοτομία και καθαρή σωλήνωση σχεδιασμένη για R410A και φροντίστε ώστε να μην εισχωρήσει νερό ή σκόνη.

Για να αποσυνδέσετε τη συσκευή από την κύρια παροχή ισχύος.

- Η συσκευή αυτή πρέπει να συνδέεται με την κύρια παροχή ισχύος μέσω ενός διακόπτη με απόσταση μεταξύ επαφών τουλάχιστον 3 mm.

Απαιτείται ασφάλεια για την εγκατάσταση (μπορεί να χρησιμοποιηθεί ασφάλεια οποιουδήποτε τύπου) για τη γραμμή τροφοδοσίας ρεύματος αυτού του κλιματιστικού μηχανήματος.

(*1) Ανατρέξτε στην ενότητα "Ορισμός Εξειδικευμένου Εγκαταστάτη ή Εξειδικευμένου Τεχνικού Σέρβις".

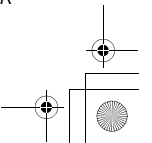
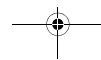
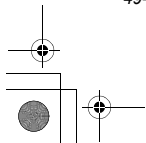

Благодарим вас за то, что приобрели кондиционер Toshiba.

Внимательно прочтите данные инструкции, так как в них содержится важная информация, соответствующая директиве "Оборудование" (Директива 2006/42/ЕС), и убедитесь, что они вам понятны. После завершения установки передайте пользователю это руководство по установке и входящее в комплект наружного блока руководство по эксплуатации и попросите пользователя хранить эти материалы в надежном месте для использования в будущем.

Общее Обозначение: Кондиционер Воздуха

Определение квалифицированного монтажника или квалифицированного специалиста по обслуживанию

Этот кондиционер должен устанавливаться, обслуживаться, ремонтироваться и демонтироваться квалифицированным монтажником или квалифицированным специалистом по обслуживанию. Каждый раз, когда вам нужно будет сделать какую-либо из этих операций, обращайтесь к квалифицированному монтажнику или специалисту по обслуживанию.

Квалифицированный монтажник или квалифицированный специалист по обслуживанию — это лицо, имеющее квалификацию и знания, указанные в таблице ниже.

Лицо	Необходимые квалификация и знание
Квалифицированный монтажник	<ul style="list-style-type: none"> Квалифицированный монтажник — это лицо, которое устанавливает, обслуживает, перемещает и демонтирует кондиционеры производства компании Toshiba Carrier Corporation. Он или она прошел обучение по вопросам установки, технического обслуживания, переустановки и демонтажа кондиционеров производства компании Toshiba Carrier Corporation, или же был научен таким действиям лицом или лицами, получившими необходимое обучение, и поэтому детально знаком со всем, что относится к указанным действиям. Квалифицированный монтажник, допущенный к выполнению необходимых электротехнических работ при установке, переустановке и демонтаже, имеет соответствующую этим работам квалификацию, предусмотренную местным законодательством и нормативами, и представляет собой лицо, обученное вопросам электротехнического характера, связанным с кондиционерами производства компании Toshiba Carrier Corporation, или же он был научен таким вопросам лицом или лицами, прошедшими необходимую подготовку, и поэтому детально знаком со всем, что относится к такой работе. Квалифицированный монтажник, допущенный к выполнению необходимых работ по прокладке трубок хладагента и обращению с хладагентом при установке, переустановке и демонтаже, имеет соответствующую этим работам квалификацию, предусмотренную местным законодательством и нормативами, и представляет собой лицо, обученное вопросам прокладки трубок хладагента и обращению с хладагентом, связанным с кондиционерами производства компании Toshiba Carrier Corporation, или же он был научен таким вопросам лицом или лицами, прошедшими необходимую подготовку, и поэтому детально знаком со всем, что относится к такой работе. Квалифицированный монтажник, допущенный к выполнению высотных работ, был обучен по вопросам, связанным с работой на высоте с кондиционерами производства Toshiba Carrier Corporation, или же получил указания по данному вопросу от лица или лиц, которые были этому обучены, и поэтому детально знаком со всем, что относится к такой работе.
Квалифицированный специалист по обслуживанию	<ul style="list-style-type: none"> Квалифицированный специалист по обслуживанию — это лицо, которое устанавливает, ремонтирует, обслуживает, перемещает и демонтирует кондиционеры производства компании Toshiba Carrier Corporation. Он или она прошел обучение по вопросам установки, ремонта, технического обслуживания, переустановки и демонтажа кондиционеров производства компании Toshiba Carrier Corporation, или же был обучен таким действиям лицом или лицами, получившими необходимое обучение, и поэтому детально знаком со всем, что относится к указанным действиям. Квалифицированный специалист по обслуживанию, допущенный к выполнению необходимых электротехнических работ при установке, ремонте, переустановке и демонтаже, имеет соответствующую этим работам квалификацию, предусмотренную местным законодательством и нормативами, и представляет собой лицо, обученное вопросам электротехнического характера, связанным с кондиционерами производства компании Toshiba Carrier Corporation, или же он был обучен таким вопросам лицом или лицами, прошедшими необходимую подготовку, и поэтому детально знаком со всем, что относится к такой работе. Квалифицированный специалист по обслуживанию, допущенный к выполнению необходимых работ по прокладке трубок хладагента и обращению с хладагентом при установке, ремонте, переустановке и демонтаже, имеет соответствующую этим работам квалификацию, предусмотренную местным законодательством и нормативами, и представляет собой лицо, обученное вопросам прокладки трубок хладагента и обращению с хладагентом, связанным с кондиционерами производства компании Toshiba Carrier Corporation, или же он был обучен таким вопросам лицом или лицами, прошедшими необходимую подготовку, и поэтому детально знаком со всем, что относится к такой работе. Квалифицированный специалист по обслуживанию, допущенный к выполнению высотных работ, был обучен по вопросам, связанным с работой на высоте с кондиционерами производства Toshiba Carrier Corporation, или же получил указания по данному вопросу от лица или лиц, которые были этому обучены, и поэтому детально знаком со всем, что относится к такой работе.

Определение средств индивидуальной защиты





При перевозке, установке, техническом обслуживании, ремонте или демонтаже кондиционера следует носить защитные рукавицы и спецодежду.

В дополнение к обычным средствам индивидуальной защиты нужно пользоваться средствами индивидуальной защиты, указанными ниже, при выполнении специальных работ, перечисленных в таблице ниже.

Если не использовать надлежащие средства индивидуальной защиты, возрастает опасность получить травму, ожоги, удар электрическим током или другие повреждения.

Выполняемая работа	Необходимые средства индивидуальной защиты
Все типы работы	Защитные рукавицы Защитная рабочая спецодежда
Работы, связанные с электричеством	Перчатки для электриков, теплозащитные рукавицы Изоляционные ботинки Одежда, обеспечивающая защиту от удара электрическим током
Работы, выполняемые на высоте (50 см или выше)	Промышленная каска
Переноска тяжелых предметов	Ботинки с дополнительным защитным носком
Ремонт наружных блоков	Перчатки для электриков, теплозащитные рукавицы

■ Предостерегающие указания на кондиционере

Предупреждающий символ	Описание		
 <table border="1"> <tr> <td>WARNING</td> </tr> <tr> <td>ELECTRICAL SHOCK HAZARD Disconnect all remote electric power supplies before servicing.</td> </tr> </table>	WARNING	ELECTRICAL SHOCK HAZARD Disconnect all remote electric power supplies before servicing.	<p>ПРЕДУПРЕЖДЕНИЯ</p> <p>ОПАСНОСТЬ ПОРАЖЕНИЯ ЭЛЕКТРИЧЕСКИМ ТОКОМ Перед выполнением обслуживания нужно отключить все внешние источники электроэнергии.</p>
WARNING			
ELECTRICAL SHOCK HAZARD Disconnect all remote electric power supplies before servicing.			
 <table border="1"> <tr> <td>WARNING</td> </tr> <tr> <td>Moving parts. Do not operate unit with grille removed. Stop the unit before the servicing.</td> </tr> </table>	WARNING	Moving parts. Do not operate unit with grille removed. Stop the unit before the servicing.	<p>ПРЕДУПРЕЖДЕНИЯ</p> <p>Движущиеся части. Запрещается работать на устройстве при движущейся решетке. Перед обслуживанием устройство нужно остановить.</p>
WARNING			
Moving parts. Do not operate unit with grille removed. Stop the unit before the servicing.			
 <table border="1"> <tr> <td>CAUTION</td> </tr> <tr> <td>High temperature parts. You might get burned when removing this panel.</td> </tr> </table>	CAUTION	High temperature parts. You might get burned when removing this panel.	<p>ПРЕДОСТЕРЕЖЕНИЕ</p> <p>Горячие детали. При снятии этой панели можно получить ожог.</p>
CAUTION			
High temperature parts. You might get burned when removing this panel.			
 <table border="1"> <tr> <td>CAUTION</td> </tr> <tr> <td>Do not touch the aluminum fins of the unit. Doing so may result in injury.</td> </tr> </table>	CAUTION	Do not touch the aluminum fins of the unit. Doing so may result in injury.	<p>ПРЕДОСТЕРЕЖЕНИЕ</p> <p>Не касайтесь алюминиевого оребрения на устройстве. Это может привести к травме.</p>
CAUTION			
Do not touch the aluminum fins of the unit. Doing so may result in injury.			
 <table border="1"> <tr> <td>CAUTION</td> </tr> <tr> <td>BURST HAZARD Open the service valves before the operation, otherwise there might be the burst.</td> </tr> </table>	CAUTION	BURST HAZARD Open the service valves before the operation, otherwise there might be the burst.	<p>ПРЕДОСТЕРЕЖЕНИЕ</p> <p>ОПАСНОСТЬ РАЗРЫВА Отсоедините все дистанционные устройства. Перед обслуживанием нужно открыть вентили, иначе может произойти разрыв.</p>
CAUTION			
BURST HAZARD Open the service valves before the operation, otherwise there might be the burst.			

1 Меры предосторожности

Производитель не несет ответственности за ущерб, вызванный несоблюдением инструкций, приведенных в данном руководстве.

⚠ ПРЕДУПРЕЖДЕНИЕ

Общие меры предосторожности

- Прежде чем приступить к установке кондиционера, внимательно прочтите Руководство по установке и в процессе работы соблюдайте изложенные в нем инструкции.
- Выполнение работы по установке разрешается только квалифицированному монтажнику или квалифицированному специалисту по обслуживанию. Неправильная установка может привести к утечке воды, поражению электрическим током или воспламенению.
- Запрещается использовать для пополнения или замены хладагент, отличный от указанного. В противном случае в контуре охлаждения может образоваться аномально высокое давление, что может привести к поломке или взрыву изделия, а также вызвать травмы.
- Прежде чем снимать решетку на воздухозаборнике внутреннего блока или на служебной панели наружного блока, установленного вне помещения, установите сетевой выключатель в положение OFF (ВЫКЛ). Если сетевой выключатель не установлен в положение OFF (ВЫКЛ), можно получить удар электрическим током при контакте с внутренними узлами кондиционера. Снимать решетку воздухозаборника на устройствах, установленных в помещении и вне его, разрешается только квалифицированным монтажникам(*1) или квалифицированным специалистам по обслуживанию(*1).
- Перед выполнением работ по установке, техническому обслуживанию, ремонту или демонтажу необходимо перевести сетевой выключатель в положение OFF (ВЫКЛ). В противном случае может произойти поражение электрическим током.
- На время выполнения работ по установке, обслуживанию, ремонту или перемещению кондиционера рядом с сетевым выключателем следует поместить знак "Ведутся работы". Если кто-либо по ошибке установит выключатель в положение ON (ВКЛ), возможно поражение работающего электрическим током.
- Только квалифицированному монтажнику(*1) или квалифицированному специалисту по обслуживанию(*1) разрешается производить работы на высоте с использованием подставки высотой 50 см или выше для того, чтобы снять решетку воздухозаборника внутреннего блока для выполнения работ.
- При ремонте, обслуживании и перемещении следует пользоваться защитными перчатками и спецодеждой.
- Не прикасайтесь к алюминиевому оребрению на устройстве. В противном случае можно получить травму. Если нужно зачистить оребрение, сначала наденьте защитные перчатки и спецодежду, а затем продолжайте работу.
- Запрещается залезать или класть какие-либо предметы на верхнюю часть наружного блока. Вы можете упасть, или же эти предметы могут свалиться с наружного блока и причинить травму.
- При работе на высоте необходимо пользоваться лестницей, отвечающей требованиям стандарта ISO 14122, и следовать указаниям, содержащимся в инструкции по работе с лестницами. При выполнении работ также нужно надевать каску принятого в промышленности образца.
- Перед очисткой фильтров или других узлов наружного блока нужно надежно установить сетевой выключатель в положение OFF (ВЫКЛ) и до начала работ выставить рядом с ним знак "Ведутся работы".
- До начала выполнения высотных работ нужно выставить предупреждающий знак, чтобы никто не приближался к зоне проведения работ. Сверху могут упасть детали или другие предметы, и нанести травму людям, находящимся внизу. Во время выполнения работы необходимо надеть каску для защиты головы от падающих предметов.
- В данном кондиционере используется хладагент R410A.
- При перевозке кондиционер должен находиться в устойчивом положении. В случае повреждения какой-либо части изделия обратитесь к дилеру.
- Переноску кондиционера должны осуществлять не менее двух человек.
- Не перемещайте и не выполняйте ремонт устройств самостоятельно. Внутри устройства находятся компоненты под высоким напряжением. Снятие крышки или основного устройства может привести к поражению электрическим током.

Выбор места установки

- При установке кондиционера в небольшом помещении необходимо принять надлежащие меры, чтобы не допустить превышения предельной концентрации хладагента даже в случае его утечки.
- Запрещается устанавливать изделие в месте, где возможны утечки горючего газа. В случае утечки газа и концентрации его вокруг блока газ может воспламениться и стать причиной пожара.
- При транспортировке кондиционера необходимо надевать ботинки с дополнительным защитным носком.
- При транспортировке кондиционера не беритесь за обвязку вокруг картонной упаковки. Если обвязка лопнет, вы можете получить травму.
- В помещении кондиционер следует устанавливать на высоте не менее 2,5 м от пола, так как в противном случае пользователи могут получить удар электрическим током или травмировать себя, если их пальцы или другие предметы попадут внутрь работающего кондиционера.
- Нельзя устанавливать какие-либо отопительные приборы в местах, где на них будет непосредственно попадать воздушный поток от кондиционера, так как это может приводить к неполному сгоранию.

Установка

- Для подвешивания внутреннего блока нужно использовать специально предназначенные для этого подвесные болты (M10 или W3/8) и гайки (M10 или W3/8).
- Кондиционер следует надежно устанавливать в месте, способном выдержать его вес. Если прочности недостаточно, то блок может упасть, нанеся травму.

- При установке кондиционера следуйте указаниям руководства по установке. Несоблюдение этих инструкций может привести к падению или опрокидыванию изделия, появлению шума, вибрации, утечки воды и другим поломкам.
- При установке примите меры для защиты от сильного ветра и землетрясений. В случае ненадлежащей установки кондиционера блок может упасть или опрокинуться и стать причиной несчастного случая.
- В случае утечки хладагента во время монтажных работ, немедленно проветрите помещение. При контакте хладагента с огнем может образоваться токсичный газ.
- Перевозить блоки кондиционера следует с помощью вилочного погрузчика, а поднимать на месте установки с помощью подъемника или лебедки.

Трубопровод хладагента

- Перед началом эксплуатации кондиционера надежно смонтируйте и закрепите трубопровод. Если кондиционер работает с открытым клапаном и без трубопровода, компрессор засасывает воздух и в контуре охлаждения давление поднимается выше нормы, что может привести к его разрыву или травмированию окружающих.
- Затягивайте конусную гайку динамометрическим ключом с заданным моментом. Чрезмерная затяжка конусной гайки может привести к тому, что со временем на ней образуется трещина, которая может привести к утечке хладагента.
- По окончании монтажных работ убедитесь в отсутствии утечек хладагента. Утечка хладагента и формирование его потока в непосредственной близости от источников огня, например, кухонной плиты, может приводить к образованию токсичного газа.
- При установке и переустановке кондиционера соблюдайте инструкции, приведенные в руководстве по установке, и выдувайте весь воздух из контура хладагента, чтобы в нем не могли смешиваться никакие другие газы, кроме хладагента. Если не удалить воздух полностью, это может привести к неисправностям в работе кондиционера.
- Для проверки на герметичность пользуйтесь азотом.
- Загрузочный шланг нужно подсоединять так, чтобы в нем нигде не было слабину.

Электропроводка

- Проводить электротехнические работы по установке кондиционера разрешается только квалифицированному монтажнику(*1) или квалифицированному специалисту по обслуживанию(*1). Ни при каких обстоятельствах эти работы нельзя поручать неквалифицированным лицам, иначе при неправильном выполнении работ возможны поражения электрическим током и/или утечка электроэнергии.
- При подключении электропроводки, ремонте электрических узлов или выполнении других электротехнических работ нужно носить защитные перчатки для электриков, теплозащитные рукавицы, изолирующие ботинки и одежду для защиты от поражения электрическим током. Если этого не сделать, возможно поражение электрическим током.
- Используйте электропроводку, которая отвечает техническим характеристикам, приведенным в данном руководстве по установке, а также местным нормативам и требованиям законодательства. Использование электропроводки, не отвечающей техническим требованиям, может привести к поражению электрическим током, утечкам электроэнергии, задымлению и/или пожару.
- Подключите провод заземления. (Работы по заземлению)
Неполное заземление может вызвать поражение электрическим током.
- Не подсоединяйте провода заземления к газопроводным и водопроводным трубам, громоотводам и проводам заземления для телефонных проводов.
- По окончании ремонтных работ или работ по переустановке кондиционера убедитесь, что провода заземления правильно подсоединены.
- Пользуйтесь сетевыми выключателями, которые отвечают техническим характеристикам, приведенным в данном руководстве по установке, а также местным нормативам и требованиям законодательства.
- Устанавливать сетевой выключатель нужно так, чтобы обслуживающее лицо могло легко до него добраться.
- При установке наружных сетевых выключателей нужно использовать такие их типы, которые специально приспособлены для установки на открытом воздухе.
- Ни в коем случае не допускается наращивать электрические кабели. Нарушение соединения в местах сращивания может привести к вызову задымлению и пожару.
- Работы по прокладке электропроводки должны выполняться в соответствии с законодательством и нормативами, принятыми в данной стране, и отвечать требованиям руководства по установке.
В противном случае возможно поражение электрическим током или короткое замыкание.

Пробный пуск

- Перед тем как запускать кондиционер после окончания работ на нем, проверьте, что крышка электрического отделения внутреннего блока и служебная панель наружного блока закрыты, и переставьте сетевой выключатель в положение ON (ВКЛ). Если этого не проверить, можно получить удар электрическим током.
- При обнаружении каких-либо неполадок в работе кондиционера (например, появилось сообщение об ошибке, запах гари, слышны странные звуки, кондиционер не охлаждает или не нагревает воздух, подтекает вода) не трогайте кондиционер, переведите его сетевой выключатель в положение OFF (ВЫКЛ) и вызовите квалифицированного специалиста по обслуживанию. До прибытия квалифицированного специалиста по обслуживанию позаботьтесь о том, чтобы электропитание кондиционера не могло быть случайно включено (например, поставьте знак "Не работает" рядом с сетевым выключателем). Продолжение эксплуатации неисправного кондиционера может привести к усугублению механических проблем и стать причиной поражения электрическим током и поломок.
- По окончании работ убедитесь при помощи устройства для проверки изоляции (мегаомметр на 500 В), что сопротивление между участком под напряжением и металлической секцией (заземлением) равно 1 МΩ или более. Если сопротивление мало, это значит, что на стороне пользователя произошла утечка электричества или пробой.
- По завершении установочных работ проверьте, нет ли утечек хладагента, проверьте сопротивление изоляции и слив воды. Затем проведите рабочее испытание, чтобы удостовериться в правильной работе кондиционера.

Пояснения для пользователя

- По завершении установочных работ покажите пользователю, где находится сетевой выключатель. Если пользователь не знает расположения сетевого выключателя, он не сможет выключить его в случае проблем с кондиционером.
- В случае повреждения решетки воздухозаборника не подходите к наружному блоку. Установите сетевой выключатель в положение OFF (ВЫКЛ) и вызовите квалифицированного специалиста по обслуживанию (*1) для ремонта. До окончания ремонта не возвращайте сетевой выключатель в положение ON (ВКЛ).
- По окончании установочных работ объясните заказчику, как эксплуатировать устройство и ухаживать за ним с помощью руководством по эксплуатации.

Переустановка на другое место

- Переустанавливать кондиционер разрешается только квалифицированному монтажнику(*1) или квалифицированному специалисту по обслуживанию(*1). В результате переустановки кондиционера неквалифицированным лицом возможны пожар, поражение электрическим током, травмы, утечка воды, шум и/или вибрация.
- При выполнении сливных работ нужно остановить компрессор до того, как отключать контур хладагента. Отсоединение трубы хладагента при открытом рабочем клапане и все еще работающем компрессоре приведет к подосу воздуха или другого газа., в результате чего давление в холодильном цикле достигнет ненормально высокого уровня, что может привести к разрыву контура, травме и другим проблемам.

⚠ ВНИМАНИЕ

Установка кондиционера с новым типом хладагента

- **ДАННЫЙ КОНДИЦИОНЕР РАБОТАЕТ С НОВЫМ ХЛАДАГЕНТОМ НА ОСНОВЕ ХФУ (R410A), НЕ РАЗРУШАЮЩИМ ОЗОНОВЫЙ СЛОЙ.**
- Характеристики хладагента R410A: легко абсорбирует воду, окисную пленку или масло, а его давление примерно в 1,6 раз выше давления хладагента R22. Одновременно с началом использования нового хладагента произошла замена компрессорного масла. В ходе работ по установке не допускайте попадания воды, пыли, устаревшего хладагента и масла в контур охлаждения.
- Для предотвращения заправки хладагента и компрессорного масла неправильных типов, размеры заправочных соединений основного устройства и размеры приспособлений отличаются от размеров аналогичных элементов для заправки обычного хладагента.
- Соответственно, для нового хладагента (R410A) требуются подходящие только для него приспособления.
- Для соединительных труб используйте новые, чистые соединения, предназначенные для R410A, и не допускайте попадания в них воды или пыли.

Для отключения устройства от источника питания.

- Это устройство должно подключаться к источнику питания с помощью выключателя с зазором между разомкнутыми контактами не менее 3 мм.

В цепи питания данного кондиционера при монтаже должен быть установлен предохранитель (могут использоваться предохранители любого типа).

(*1) См. "Определение квалифицированного монтажника или квалифицированного специалиста по обслуживанию".

Bu Toshiba klimayı satın aldıktan sonra teşekkür ederiz.

Lütfen "Makine" Direktifine (Direktif 2006/42/EC) uygun olan ve önemli bilgiler içeren bu talimatları batan sonra dikkatle ve anlayarak okuyun.

Kurulumu iini tamamladıktan sonra, d ünitenin beraberindeki bu Kurulum Klavuzu'nu ve Kullanıcı Klavuzu'nu kullanıncaya verin ve kullanıcıdan bu belgeleri gelecekte bavuru için güvenli bir yerde saklamalarını isteyin.

Jenerik Ad: Klima

Kalifiye Montaj Eleman veya Kalifiye Servis Eleman Tarifi

Klima, kalifiye montaj elemanı veya kalifiye servis elemanı tarafından monte edilmeli, bakım yapılmalı, onarımlı veya sökülmemelidir. Bu ilerden herhangi birinin yapılması gerekiyorsa sizin için yapması için kalifiye montaj elemanı veya kalifiye servis elemanı çağırın.

Kalifiye montaj elemanı veya kalifiye servis elemanı aadaki tabloda verilen niteliklere ve bilgiye sahip bir acentadır.

Acenta	Acentanın sahip olması gerekli nitelikler ve bilgiler
Kalifiye montaj elemanı	<ul style="list-style-type: none"> Yetkili montaj, Toshiba Carrier Corporation tarafından üretilen klimaların montaj, bakım, yer deitirme ve söküm işlemlerini gerçekleştiren ahrs. Bu ahs Toshiba Carrier Corporation tarafından üretilen klimaların montaj, bakım, yer deitirme ve söküm işlemlerini gerçekleştirecek şekilde eğitim almıtr ya da eğitim alm ve bu işlemlerle ilgili bilgiye tamamen hakim olan bir ahs ya da ahsların talimatları dorultusunda bu işlemleri gerçekleştirmektedir. Montaj, yer deitirme ve söküm işlemlerinde her türlü elektrik iini yapan yetkili montaj personeli, bu elektrik ileri ile ilgili yerel kanun ve düzenlemeler tarafından art koulan niteliklere sahiptir ve Toshiba Carrier Corporation tarafından üretilen klimalar üzerinde gerçekleştirilen elektrik ileri konusunda eğitim almıtr ya da eğitim alm ve bu ilerle ilgili bilgiye tamamen hakim olan bir ahs ya da ahsların talimatları dorultusunda bu işlemleri gerçekleştirmektedir. Montaj, yer deitirme ve söküm işlemlerinde her türlü soutucu akkan kullanm ve boru tesisat iini yapan yetkili montaj personeli, bu soutucu akkan kullanm ve boru tesisat ileri ile ilgili yerel kanun ve düzenlemeler tarafından art koulan niteliklere sahiptir ve Toshiba Carrier Corporation tarafından üretilen klimalar üzerinde gerçekleştirilen soutucu akkan kullanm ve boru tesisat ileri konusunda eğitim almıtr ya da eğitim alm ve bu ilerle ilgili bilgiye tamamen hakim olan bir ahs ya da ahsların talimatları dorultusunda bu işlemleri gerçekleştirmektedir. Yüksek montaj noktalarında çalışan yetkili montaj personeli, Toshiba Carrier Corporation tarafından üretilen klimalarla yüksek noktalarda çalışacak şekilde eğitim almıtr ya da eğitim alm ve bu işlemlerle ilgili bilgiye tamamen hakim olan bir ahs ya da ahsların talimatları dorultusunda bu işlemleri gerçekleştirmektedir.
Kalifiye servis elemanı	<ul style="list-style-type: none"> Yetkili servis personeli, Toshiba Carrier Corporation tarafından üretilen klimaların montaj, onarm, bakım, yer deitirme ve söküm işlemlerini gerçekleştiren ahrs. Bu ahs Toshiba Carrier Corporation tarafından üretilen klimaların montaj, onarm, bakım, yer deitirme ve söküm işlemlerini gerçekleştirecek şekilde eğitim almıtr ya da eğitim alm ve bu işlemlerle ilgili bilgiye tamamen hakim olan bir ahs ya da ahsların talimatları dorultusunda bu işlemleri gerçekleştirmektedir. Montaj, onarm, yer deitirme ve söküm işlemlerinde her türlü elektrik iini yapan yetkili servis personeli, bu elektrik ileri ile ilgili yerel kanun ve düzenlemeler tarafından art koulan niteliklere sahiptir ve Toshiba Carrier Corporation tarafından üretilen klimalar üzerinde gerçekleştirilen elektrik ileri konusunda eğitim almıtr ya da eğitim alm ve bu ilerle ilgili bilgiye tamamen hakim olan bir ahs ya da ahsların talimatları dorultusunda bu işlemleri gerçekleştirmektedir. Montaj, onarm, yer deitirme ve söküm işlemlerinde her türlü soutucu akkan kullanm ve boru tesisat iini yapan yetkili servis personeli, bu soutucu akkan kullanm ve boru tesisat ileri ile ilgili yerel kanun ve düzenlemeler tarafından art koulan niteliklere sahiptir ve Toshiba Carrier Corporation tarafından üretilen klimalar üzerinde gerçekleştirilen soutucu akkan kullanm ve boru tesisat ileri konusunda eğitim almıtr ya da eğitim alm ve bu ilerle ilgili bilgiye tamamen hakim olan bir ahs ya da ahsların talimatları dorultusunda bu işlemleri gerçekleştirmektedir. Yüksek montaj noktalarında çalışan yetkili servis personeli, Toshiba Carrier Corporation tarafından üretilen klimalarla yüksek noktalarda çalışacak şekilde eğitim almıtr ya da eğitim alm ve bu işlemlerle ilgili bilgiye tamamen hakim olan bir ahs ya da ahsların talimatları dorultusunda bu işlemleri gerçekleştirmektedir.

Koruyucu Kyafet Tarifi





Klimanın tanması, monte edilmesi, bakımın ve onarımın yapılması veya sökülmesi sırasında koruyucu eldivenler ile i 'güvenli' kyafetlerini giyin.

Bu tür normal koruyucu kyafetlere ek olarak, aadaki tabloda açıklanan özel ileri gerçekleştiren tabloda açıklanan koruyucu kyafetleri giyin.

Doru koruyucu kyafetin kullanılmaması yaralanma, yank, elektrik çarpması ve dier yaralanmalara daha müsait olacaktır için tehliktedir.

Yapılan i	Giyecek koruyucu kyafet
Her türlü i	Koruyucu i eldiveni 'Güvenli' kyafeti
Elektrik ileri	Elektrikçiler için, sya koruma salayan eldiven Yalıtıcı ayakkabılar Elektrik çarpmasına koruma salayan kyafetler
Yüksekte yapılan iler (50 cm veya daha fazla)	Endüstri tipi baret
Ar nesnelere tanması	Parmak ucu güçlendirilmiş ayakkabı
D ünite onarm	Elektrikçiler için, sya koruma salayan eldiven

■ Klima üzerindeki uyar göstergeleri

Uyar etiketi	Açıklama
 <p>WARNING ELECTRICAL SHOCK HAZARD Disconnect all remote electric power supplies before servicing.</p>	<p>UYARI</p> <p>ELEKTRİK ÇARPMAYA TEHLİKESİ Servis/bakım yapmadan önce uzaktaki tüm elektrik güç kaynaklarını ayırın.</p>
 <p>WARNING Moving parts. Do not operate unit with grille removed. Stop the unit before the servicing.</p>	<p>UYARI</p> <p>Hareketli parçalar. Izgara çıkarılmı durumda üniteyi çalıştırmayın. Servis/bakım yapmadan önce üniteyi durdurun.</p>
 <p>CAUTION High temperature parts. You might get burned when removing this panel.</p>	<p>DIKKAT</p> <p>Çok sıcak parçalar. Bu paneli sökme riski yanabilirsiniz.</p>
 <p>CAUTION Do not touch the aluminum fins of the unit. Doing so may result in injury.</p>	<p>DIKKAT</p> <p>Ünitenin alüminyum kanatçıklara dokunmayın. Aksi takdirde yaralanmaya neden olabilir.</p>
 <p>CAUTION BURST HAZARD Open the service valves before the operation, otherwise there might be the burst.</p>	<p>DIKKAT</p> <p>PATLAMAYA TEHLİKESİ Çalıştırmadan önce servis valflerini açın, aksi takdirde patlama olabilir.</p>

1 Güvenlik Önlemleri

Üretici, bu klavuzdaki açıklamaların incelenmemesinden kaynaklanan zararlardan sorumlu tutulamaz.

⚠ UYARI

Genel

- Klimayı monte etmeye başlamadan önce Montaj Klavuzu'nu batan sona dikkatlice okuyun ve klimayı monte etmek için verilen talimatları takip edin.
- Montaj çalışmasını yalnızca yetkili bir montaj veya servis uzman gerçekleştirebilir. Yanlış kurulum; su sızıntıları, elektrik çarpması veya yangınla sonuçlanabilir.
- Tamamlayıcı veya yedek olarak belirtilenden farklı bir sömütücü kullanmayın. Aksi takdirde, sömütme döngüsünde anormal yüksek basınç üretilir ve bu da ürünün arızalanmasıyla veya patlamasıyla ya da insanların yaralanmasıyla sonuçlanabilir.
- Ç ünitenin emi zgarasını veya d ünitenin servis panelini açmadan önce devre kesicini KAPALI konuma alın. Devre kesicinin KAPALI konuma alınmaması, iç parçalarla temas sonucu elektrik çarpmasına neden olabilir. Ç ünitenin emi zgarasını veya d ünitenin servis paneli yalnızca kalifiye montaj elemanı(*1) veya kalifiye servisi elemanı(*1) tarafından sökülebilir ve gerekli işlemleri yapılabilir.
- Montaj, bakım, onarım veya sökme işlemlerini yapmadan önce devre kesicini mutlaka KAPALI konuma alın. Aksi takdirde elektrik çarpmasına neden olabilir.
- Montaj, bakım, onarım veya sökme işlemlerini yaparken devre kesicinin yanına "Çalışma yapıyor" iareti yerleştirin. Devre kesicinin yanlışlıkla AÇIK konuma alınması elektrik çarpmaya tehlikesine yol açar.
- 50 cm veya daha yüksek bir stand kullanarak yüksek yerlerde iş yapmaya veya iş yapmak üzere iç ünitenin emi zgarasını sökmeye yalnızca kalifiye montaj elemanı(*1) veya kalifiye servisi elemanı(*1) yetkilidir.
- Montaj, servis/bakım ve sökme sırasında koruyucu i eldiveni ve emniyet maksatlı i elbisesi giyin.
- Ünitenin alüminyum kanatçığa dokunmayın. Dokunursanız yaralanabilirsiniz. Herhangi bir nedenle kanatçıklara dokunmak gerekirse önce koruyucu i eldiveni ile emniyet maksatlı i elbisesi giyin ve daha sonra devam edin.
- D ünitenin üzerine trmanmayın ya da üzerine eya koymayın. Düşme sonucu yaralanabilirsiniz ya da d ünitenin üzerindeki eyalar düreerek yaralanmaya neden olabilir.
- Yüksek yerlerde çalışırken ISO 14122 standardına uygun bir merdiven kullanın ve merdiven kullanma klavuzundaki prosedürü takip edin. Ayrıca iş yapmak için koruyucu kiyafet olarak endüstri tipi baret takın.
- D ünitenin filtresini veya diğer parçaların temizlemesinden önce devre kesicini mutlaka KAPALI konuma alın ve işe başlamadan önce devre kesicinin yanına "Çalışma yapıyor" iareti yerleştirin.
- Yüksek yerlerde çalışmadan önce, işe başlamadan önce çallan yere kimsenin yaklaşmaması için bir iareti yerleştirin. Parçalar ve diğer nesneler yukarıdan düşerek muhtemelen aadaki birinin yaralanmasına neden olabilir. Çalışırken, düşen nesnelere dikkat etmek için kask takın.
- Bu klima tarafından R410A sömütücü kullanılmaktadır.
- Klima, sarımsıktan tanınmaz. Ürünün herhangi bir parçası kırıkta satılmaz.
- Klimanın elle tanınması gerektiğinde, iki veya daha fazla kişi tarafından tanınmalıdır.
- Herhangi bir bölümü kendi başına veya tamir etmeye çalışmayın. Ünite içinde yüksek gerilim mevcuttur. Kapa ve ana üniteyi sökme riski elektrik çarpmasına maruz kalabilirsiniz.

Montaj yerinin seçilmesi

- Klima küçük bir odaya kurulduysa, odadaki sömütücü konsantrasyonunun kritik düzeyi amamasını sağlamak için gerekli önlemleri alın.
- Patlayıcı gaz kaçabileceği yerlere monte etmeyin. Gaz kaçarsa veya ünitenin çevresinde gaz birikirse bu sırada ateşlenebilir ve yangın çıkmasına neden olabilir.
- Klimayı tarken parmak ucunu güçlendirilmiş ayakkabı giyin.
- Klimayı tarken ambalaj kutusunun etrafındaki eritleri çıkarmayın. eritler kırılırsa yaralanmanıza neden olabilir.
- Klima çalışırken kullanımlar parmakların veya baka nesnelere iç üniteye sokmaları halinde yaralanabileceklerinden veya elektrik çarpmasına maruz kalabileceklerinden dolayı iç üniteyi zemin seviyesinden en az 2,5 m yukarı monte edin.
- Klimanın rüzgarına doğrudan maruz kalan yerlere üniteyi aygıtlar yerleştirmeyin aksi takdirde hatalı çalışmaya neden olabilir.

Montaj

- Ç ünite askıya alınacaksa belirtilen ask çvataları (M10 veya W3/8) ve somunlar (M10 veya W3/8) kullanılmamalıdır.
- Klimayı, tabanın aralığı yeterince kalırdırabileceği bir yere sağlam bir şekilde kurun. Mukavemet yeterli değilse ünite düşerek yaralanmaya neden olabilir.
- Klimayı monte etmek için Montaj Klavuzundaki talimatları takip edin. Bu talimatların takip edilmemesi ürünün düşmesine ya da devrilmesine veya gürültü, titreşim, su sızıntısı veya baka bir hasara neden olabilir.

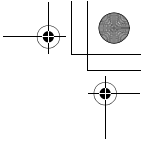
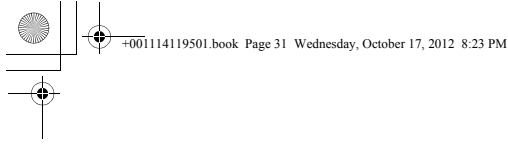

- Sert rüzgar ve deprem olasına kar korumak için kurulumu belirtildiği eklede gerçekleştirin. Klima düzgün ekilde kurulmazsa, ünite devrilerek veya dükerek kazaya neden olabilir.
- Kurulum çalmas srasnda soutucu gaz sznt yapıysa, oday hemen havalandırn. Szan soutucu gazn atele temas etmesi durumunda zehirli gaz oluabilir.
- Klima ünitesini tamak için forklift ve bunları kurulumu için vinç veya kaldıraç kullan.

Soutucu borusu

- Klimayı çalıtımadan önce montaj srasnda soutucu borusunu salam bir ekilde takn. Valf açık durumda soutucu borusu olmadan kompresör çalsra kompresör havay emer ve soutma devresinde ar basınca yol açarak yaranlamaya neden olabilir.
- Hava somununu tork anahtarla belirtilen ekilde skn. Hava somununun fazla sklması uzun vadede hava somununda çatlamaya yol açarak soutucu kaçana neden olabilir.
- Kurulum çalmasndan sonra soutucu gazn sznt yapmadan onaylayn. Odaya soutucu gaz szar ve frn gibi s kaynakların yakına akarsa zehirli gaz oluabilir.
- Klima monte edilirken veya yeri deitirilirken soutucu devresine soutucu haricinde baka gazları karmasın engellemek için Montaj Klavuzundaki talimatlar takip ederek havayı tamamen boşaltın. Havanın tamamen boşaltılmaması klimanın arızalanmasına neden olabilir.
- Hava szdirmazlık testi için nitrojen gazı kullanılmaldır.
- Doldurma hortumu sarkmayacak ekilde balanmalıdır.

Elektrik kablosu

- Klimanın elektrik ileri yalnızca kalifiye montaj elemanı(*1) veya kalifiye servisi elemanı(*1) tarafından yapılabilir. in düzgün yapılmaması elektrik çarpmasına ve/veya elektrik kaçaklarına neden olabileceğinden dolayı bu iş asla kalifiye olmayan kişilerce yapılmamalıdır.
- Elektrik kabloların balamak, elektrikli parçaları onarmak veya diğer elektrik ilerini yapmak için, şya koruma salayan eldiven, yalıtım ayakkabı ve elektrik çarpmalarına karşı koruma salayan kıyafet giyin. Bu koruyucu kıyafetlerin giyilmemesi elektrik çarpmasına neden olabilir.
- Montaj Klavuzundaki teknik özellikleri karlıyan ve yerel yasalar ve yönetmeliklerin art kotuu kabloları kullan. Teknik özellikleri karlamayan kablo kullanılması elektrik çarpmasına, elektrik kaçana, duman çıkmasına ve/veya yangına neden olabilir.
- Topraklama kablosunu balayın. (Topraklama ii) Yetersiz topraklama elektrik çarpmasına neden olur.
- Topraklama kabloların gaz borularına, su borularına ve paratonerlere ya da telefon toprak hatlarına balamayın.
- Onarm veya yer deitirme işini tamamladıktan sonra topraklama kabloların düzgün balanıp balanmadn kontrol edin.
- Montaj Klavuzundaki teknik özellikleri karlıyan ve yerel yasalar ve yönetmeliklerin art kotuu bir devre kesici kullan.
- Devre kesiciyi acenta tarafından kolayca erişilebilecek bir yere monte edin.
- Devre kesiciyi diğer mekanlara monte ederken diğer mekanlar için tasarlanmış olan bir devre kesici kullan.
- Güç kablosu hiçbir art alında uzatılmamalıdır. Kablonun uzatıldığı yerlerdeki balant problemi duman çıkmasına ve/veya yangına neden olabilir.
- Elektrik kablo ilerini toplumdaki ve montaj klavuzunda yer alan yasa ve düzenlemelere göre gerçekleştirilmelidir. Aksi takdirde elektrik çarpması sonucu ölüm veya ksa devre meydana gelebilir.

Test çalıtması

- i tamamladıktan sonra klimayı çalıtımadan önce iç ünitenin elektrikli parçaları kutusunun kapa ile d ünitenin servis panelinin kapalı olduğunu kontrol edin ve devre kesiciyi AÇIK konuma alın. Önce bu kontroller yapılmadan elektrik verilirse elektrik çarpmasına maruz kalabilirsiniz.
- Herhangi bir hasar (örn. hata mesaj görüntülenirse, yankı kokusu varsa, normal olmayan sesler geliyorsa, klima soutma veya stma yapıyorsa ya da su sznts varsa) varsa, klimaya dokunmayın ve devre kesiciyi KAPALI konuma alın, kalifiye servis elemanı çağırın. Kalifiye servis elemanı gelene dek elektrik verilmemesi için gerekli önlemleri alın (örneğin devre kesicinin yanına "servis d" iareti koyun). Klimanın sorunlu ekilde kullanılmaya devam edilmesi mekanik sorunların artmasına, elektrik çarpmasına veya diğer hasarlara neden olabilir.
- in tamamlanmasından arından bir yalıtım test cihazı (500 V Megger) kullanarak arız bölümü ve arız edilmeyen metal bölüm (topraklama bölümü) arasındaki direncin 1 MΩ veya daha fazla olup olmadığını kontrol edin. Direnç değeri düşükse kullanıca tarafında elektrik kaçışı veya elektrik çarpması meydana gelebilir.
- Montaj işi tamamlandıktan sonra soutucu kaçaklarını, yalıtım direncini ve su tahliyesini kontrol edin. Daha sonra klimanın düzgün çalıtımını kontrol etmek için bir test çalıtması yapın.

Kullanıca verilecek açıklamalar

- Montaj işi tamamlandıktan sonra kullanıca devre kesicinin yerini gösterin. Kullanıca devre kesicinin yerini bilmiyorsa klimada bir sorun meydana geldiğinde devre kesiciyi kapatamayacaktır.
- Fan zgarası hasar görmüşse, d üniteye yaklaşmayın, devre kesiciyi OFF (KAPALI) konuma getirin ve onarm işlemini gerçekleştirmesi için yetkili bir servis personeline (*1) haber verin. Onarm yapılmaya kadar devre kesiciyi AÇIK konuma almayın.
- Montaj işi tamamlandıktan sonra müşteriye ünitenin kullanımı ve bakımının nasıl yapılacağını Kullanım Klavuzunu takip ederek açıklayın.

Yer deitirme

- Klimanın yeri yalnızca kalifiye montaj elemanı(*1) veya kalifiye servisi elemanı(*1) tarafından deitirilebilir. Klimanın yerinin kalifiye olmayan biri tarafından deitirilmesi yangın, elektrik çarpması, yaralanma, su kaçağı, gürültü ve/veya titreşime neden olacandan dolayı tehlikelidir.
- Gaz toplama (pump-down) işi yaparken soutucu borusunu sökmeden önce kompresörü kapatın. Servis valfi açık ve kompresör çalırken soutucu borusu balantsız kesilmesi hava veya baka bir gazın emilmesine neden olur, soutma devresinin iç basınç anormal yüksek bir seviyeye arttır ve parçalanma, yaralanma veya diğer sorunlara neden olabilir.

⚠ DİKKAT

Yeni Soutuculu Klima Montaj

- **BU KLİMA, OZON TABAKASINA ZARAR VERMEYEN YENİ HFC SOUTUCUSU (R410A) KULLANMAKTADIR.**
- R410A soutucunun özellikleri: suyu emme kolay, oksitleyici membran veya ya ve basınç R22 soutucudan yaklaşık 1.6 kat daha yüksek olmalıdır. Yeni soutucunun beraberinde gelen soutma ya da deitirilmidir. Bu nedenle, kurulum çalmas srasnda soutma döngüsüne su, toz, eski soutucu veya soutma ya girmesine izin vermeyin.
- Yanlı soutucu ve soutma yantı dolulumunu önlemek için, ana ünitenin ve kurulum araçlarının doldurma balant noktasının balant bölümlerinin boyutları konvansiyonel soutucudakilerden farklıdır.
- Buna uygun olarak yeni (R410A) soutucu için harici araçlar gerekir.
- Balant borularında, R410A için tasarlanmış yeni ve temiz borular kullanın ve lütfen suyun ya da tozun girmemesi için dikkatli olun.

Cihazın Ana Güç Kayna Balantsız Kesilmesi.

- Bu cihaz, en az 3 mm'lik kontak ayrımlı bulunan bir anahtar vastasıyla ana güç kaynağına balanmalıdır.





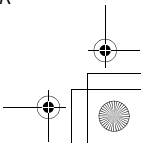
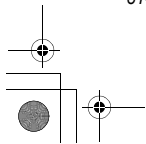



Bu klimanın güç kaynağı hattı için montaj sigortası (her türlü sigorta kullanılabılır) kullanılmaldır.

(*1) Bakınız: "Kalifiye Montaj Elemanı veya Kalifiye Servis Elemanı Tarifleri".



2 Accessory parts

■ Accessory parts

Part name	Q'ty	Shape	Usage
Installation Manual	1	This manual	(Hand over to customers) (For other languages that do not appear in this Installation Manual, please refer to the enclosed CD-R.)
CD-ROM	1	—	Installation Manual
Heat insulating pipe	2		For heat insulation of pipe connecting section
Installation pattern	1	—	For confirmation of ceiling opening and indoor unit position
Installation gauge	--		For positioning of ceiling position
Washer	4		For hanging-down unit
Eccentric washer	4		For hanging-down unit
Hose band	1		For connecting drain pipe
Flexible hose	1		For adjusting center of drain pipe
Heat insulator	1		For heat insulation of drain connecting section
Heat insulator	1		For sealing of wire connecting port

■ Separate sold parts

- The Ceiling panel and remote controller are sold separately. For the installation of these products, follow the Installation Manuals supplied with them.
- The wireless type remote controller is designed to be installed by attaching a wireless remote controller kit (sold separately) to the standard panel. (The wireless remote controller kit consists of a wireless remote controller and adjust corner caps with a receiver section.)

3 Selection of installation place

⚠ WARNING

- Install the air conditioner at enough strong place to withstand the weight of the unit.
If the strength is not enough, the unit may fall down resulting in injury.
- Install the air conditioner at a height 2.5 m or more from the floor.
If you insert your hands or others directly into the unit while the air conditioner operates, it is dangerous because you may contact with revolving fan or active electricity.

⚠ CAUTION

- Do not install the air conditioner in a location subject to a risk of exposure to a combustible gas.
If a combustible gas leaks and stays around the unit, a fire may occur.

Upon approval of the customer, install the air conditioner in a place that satisfies the following conditions

- Place where the unit can be installed horizontally.
- Place where a sufficient servicing space can be ensured for safety maintenance and check.
- Place where drained water will not cause any problem.

Avoid installing in the following places

- Place exposed to air with high salt content (seaside area), or place exposed to large quantities of sulfide gas (hot spring).
(Should the unit be used in these places, special protective measures are needed.)
- A restaurant kitchen where a lot of oil is used or place near machines in a factory (Oil adhering to the heat exchanger and resin part (turbo fan) in the indoor unit may reduce the performance, generate mist or dew drop, or deform or damage resin parts.)
- Places where iron or other metal dust is present. If iron or other metal dust adheres to or collects on the interior of the air conditioner, it may spontaneously combust and start a fire.
- Place where organic solvent is used nearby.
- Place close to a machine generating high frequency.
- Place where the discharged air blows directly into the window of the neighbor house. (Outdoor unit)
- Place where noise of the outdoor unit is easily transmitted.
(When install the outdoor unit on the boundary with the neighbor, pay due attention to the level of noise.)
- Place with poor ventilation. (Before air ducting work, check whether value of air volume, static pressure and duct resistance are correct.)
- Do not use the air conditioner for special purposes such as preserving food, precision instruments, or art objects, or where breeding animals or growing plants are kept. (This may degrade the quality of preserved materials.)
- Place where any of high-frequency appliances (including inverter devices, private power generators, medical equipment, and communication equipment) and inverter-type fluorescent light is installed.
(A malfunction of the air conditioner, abnormal control, or problems due to noise to such appliances / equipment may occur.)
- When the wireless remote controller is used in a room equipped with an inverter-type fluorescent light or at a place exposed to direct sunlight, signals from the remote controller may not be received correctly.
- Place where organic solvent is used.
- Place near a door or window exposed to humid outside air (Dew dropping may form.).
- Place where special spray is used frequently.

Installation space

Secure the specified space in the figure for installation and servicing.

Model MMU-	A mm
AP009 Type to AP030 Type	271 or more
AP036 Type to AP056 Type	334 or more

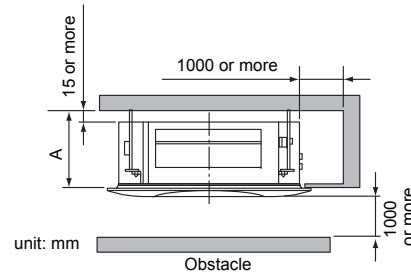

When incorporating fresh-air intake box (sold separately)

Provide an inspection opening at the outside-air intake box side.

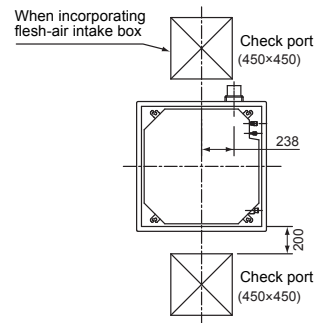

Selection of installation place

In case of continued operation of the indoor unit under high-humidity conditions as described below, dew may condense and water may drop. Especially, high-humidity atmosphere (dew point temperature : 23 °C or more) may generate dew inside the ceiling.

- Unit is installed inside the ceiling with slated roof.
- Unit is installed at a location using inside of the ceiling as fresh air take-in path.
- Kitchen

Advice

- Set a service check opening panel at right side of the unit (size: 450 × 450 mm or more) for piping, maintenance, and servicing.
- If installing a unit at such place, put insulating material (glass wool, etc.) additionally on all the positions of the indoor unit which come to contact with high-humidity atmosphere.

REQUIREMENT

When the humidity inside the ceiling seems to be higher than 80 %, attach a heat insulator to the side (top) surface of the indoor unit. (Use a heat insulator that is 10 mm or more thick.)

Ceiling height

When the height of the ceiling exceeds the distance of the item Standard / 4-way in Table on the next page, the hot air is difficult to reach the floor.

Therefore, it is necessary to change the setup value of the high ceiling switch or discharge direction. The high-ceiling setting is also necessary when installing separately sold filters.

REQUIREMENT

- When using the air conditioner with 2-way / 3-way discharge system, a strong wind blows directly if the ceiling height is lower than the standard. Therefore, change the setting switch according to height of the ceiling.
- When using the high ceiling (1) or (3) with 4-way discharge system, the draft is apt to be felt due to drop of the discharge temperature.
- AP009 Type and AP012 Type air conditioners cannot be installed on a high ceiling.

Height list of ceiling possible to be installed

(Unit: m)

Model MMU-	AP009 to AP012			AP015 to AP018			AP024 to AP030			AP036 to AP056			Setup of high ceiling
Discharge direction	4-way	3-way	2-way	4-way	3-way	2-way	4-way	3-way	2-way	4-way	3-way	2-way	SET DATA
Standard (Factory default)	2.7	2.8	3.0	2.8	3.2	3.5	3.0	3.3	3.6	3.9	4.2	4.5	0000
High ceiling (1)	—	—	—	3.2	3.5	3.8	3.3	3.5	3.8	4.2	4.4	4.6	0001
High ceiling (3)	—	—	—	3.5	3.8	—	3.6	3.8	—	4.5	4.6	—	0003

The lighting time of the filter sign (notification of filter cleaning) on the remote controller can be changed according to installation conditions.

When it is difficult to obtain satisfactory heating due to location place of the indoor unit or the structure of the room, the detection temperature of heating can be raised.

Discharge direction

As shown in the figure below, air discharge directions can be selected according to the shape of the room and the location of the indoor unit installation.

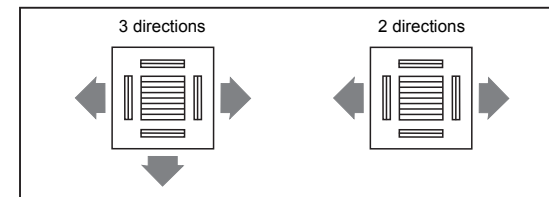

Use a shielding plate kit (sold separately) to change discharge directions.

Discharge directions are limited. Follow the Installation Manual supplied with the shielding plate kit.

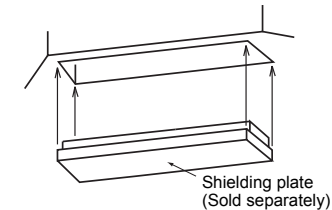

4 Installation

REQUIREMENT

- Strictly comply with the following rules to prevent damage of the indoor units and human injury.
- Do not put a heavy article on the indoor unit. (Even units are packaged)
 - Carry in the indoor unit as it is packaged if possible. If carrying in the indoor unit unpacked by necessity, be sure to use buffering cloth, etc. to not damage the unit.
 - To move the indoor unit, hold the hooking metals (4 positions) only.
Do not apply force to the other parts (refrigerant pipe, drain pan, foamed parts, or resin parts, etc.).
 - Carry the package by two or more persons, and do not bundle it with plastic band at positions other than specified.

External view

(Unit:mm)

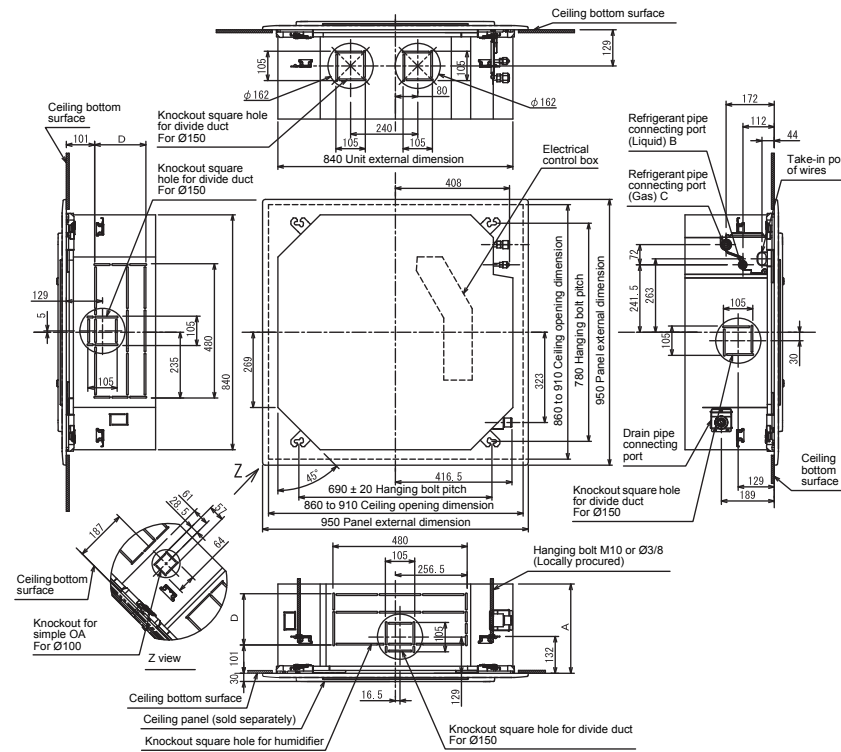

Model MMU-	A	B	C	D	Model MMU-	A	B	C	D
AP009 to AP012	256	Ø6.4	Ø9.5	120	AP024 to AP030	256	Ø9.5	Ø15.9	120
AP015 to AP018	256	Ø6.4	Ø12.7	120	AP036 to AP056	319	Ø9.5	Ø15.9	183

(mm)

Opening a ceiling and installation of hanging bolts

- Consider the piping / wiring after the unit is hung when determining the location of the indoor unit installation and orientation.
- After the location of the indoor unit installation has been determined, open the ceiling and install hanging bolts.
- The dimensions of the ceiling opening and hanging bolt pitches are given in the outline drawing and the attached installation pattern.
- When a ceiling already exists, lay the drain pipe, refrigerant pipe, indoor unit / outdoor unit connection wires, and remote controller wires to their connection locations before hanging the indoor unit.

Procure hanging bolts and nuts for installing the indoor unit (these are not supplied).

Hanging bolt	M10 or W3/8	4 pieces
Nut	M10 or W3/8	12 pieces

Using the installation pattern (accessory)

The installation pattern is provided inside the packaging cap.

<For existing ceiling>

Use the installation pattern positioning a ceiling opening and hanging bolts.

<For new ceiling>

Use the installation pattern to position the ceiling opening when hanging a ceiling.

- After the hanging bolts have been installed, install the indoor unit.
- Hook the four holes in the installation pattern to the panel fixing screws of the indoor unit.
- When hanging a ceiling, open the ceiling along the outside dimensions of the installation pattern.

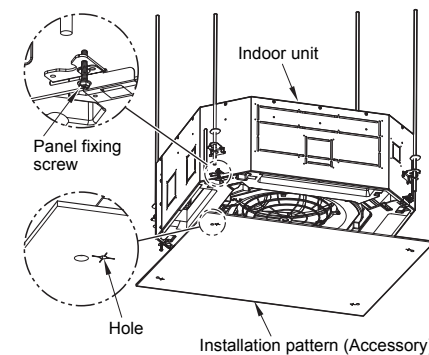

Treatment of ceiling

The ceiling differs according to structure of building. For details, consult your constructor or interior finish contractor.

In the process after the ceiling board has been removed, it is important to reinforce ceiling foundation (frame) and to keep horizontal level of installed ceiling correctly in order to prevent vibration of ceiling board.

1. Cut and remove the ceiling foundation.
2. Reinforce the cut surface of ceiling foundation, and add ceiling foundation for fixing the end of ceiling board.

Installation of hanging bolt

Use M10 hanging bolts (4 pcs, locally procured). Matching to the existing structure, set pitch according to size in the unit external view as shown below.

New concrete slab	
Install the bolts with insert brackets or anchor bolts.	
(Blade type bracket)	(Slide type bracket)
Rubber Anchor bolt (Pipe hanging anchor bolt)	
Steel frame structure	
Use existing angles or install new support angles.	
Hanging bolt Hanging bolt Support angle	
Existing concrete slab	
Use a hole-in anchors, hole-in plugs, or a hole-in bolts.	

◆ Installation of ceiling opening and hanging bolt

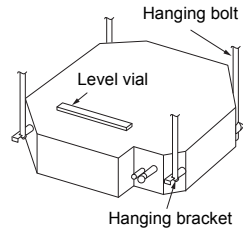

- Attach a nut (M10 or W3/8: not supplied) and the Ø34 washer (supplied) to each hanging bolt.
- Insert a washer on both sides of the T groove of the hanging bracket of the indoor unit, and hang the indoor unit.
- Check that the four sides of the indoor unit are level using a level vial (levelness: 5 mm or less).
- Detach the installation gauge (accessory) from the installation pattern.
- Using the installation gauge, check and adjust the positional relation between the indoor unit and the ceiling opening (1) (10 to 35 mm: 4 sides) and the hanging-up height (2) (12^{±5} mm: 4 corners). (How to use the installation gauge is printed on the gauge.)

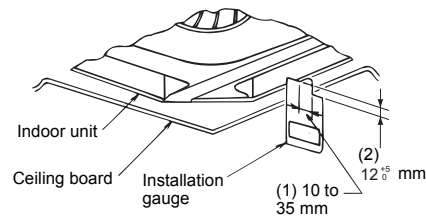
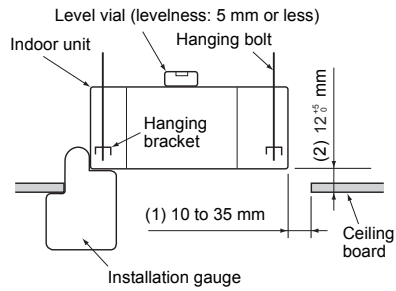
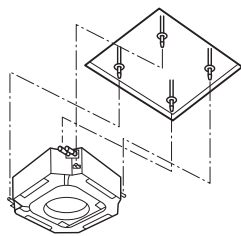
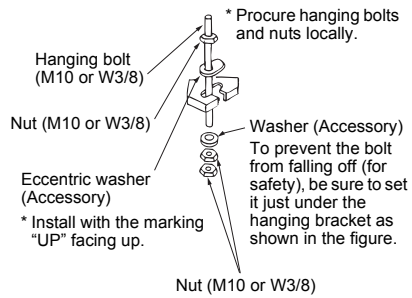

REQUIREMENT

Before installation of the indoor unit, be sure to remove the tape for transportation between the fan and the bell mouth. Running the unit without removing the tape may damage the fan motor.

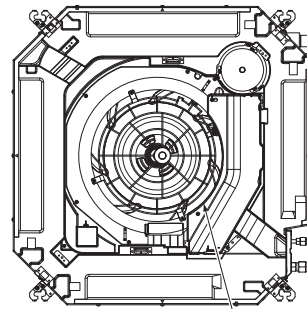

Be sure to remove the tape for transportation between the fan and the bell mouth.

■ Installation of ceiling panel (Sold separately)

Install the ceiling panel according to Installation Manual attached with it after piping / wiring work has completed.

Check that installation of indoor unit and ceiling opening part is correct, and then install it.

REQUIREMENT

- Joint the connecting sections of ceiling panel, ceiling surface, ceiling panel and indoor unit closely. Any gap between them will cause air leakage and generate condensation or water leakage.
- Remove the adjust corner caps at the four corners of the ceiling panel, and then install the ceiling panel onto the indoor unit.
- Make sure that the claws of the four adjust corner caps are securely fit.
* Improper fitting of the claws may cause water leakage.

■ Installation of remote controller (Sold separately)

For installation of the wired remote controller, follow the Installation Manual attached with the remote controller.

- Pull out the remote controller cord together with the refrigerant pipe or drain pipe.
Be sure to pass the remote controller cord through upper side of the refrigerant pipe and drain pipe.
- Do not leave the remote controller at a place exposed to the direct sunlight and near a stove.

■ Wireless type

The sensor of indoor unit with wireless remote controller can receive a signal by distance within approx. 8 m. Based upon it, determine a place where the remote controller is operated and the installation place.

- Operate the remote controller, confirm that the indoor unit receives a signal surely, and then install it.
- Keep 1 m or more from the devices such as television, stereo, etc. (Disturbance of image or noise may generate.)
- To prevent a malfunction, select a place where is not influenced by a fluorescent light or direct sunlight.
- Two or more (Up to 6 units) indoor units with wireless type remote controller can be installed in the same room.

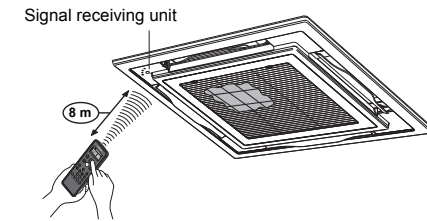

5 Drain piping

CAUTION

Following the Installation Manual, perform the drain piping work so that water is properly drained, and apply a heat insulation so as not to cause a dew dropping. Inappropriate piping work may result in water leakage in the room and wet of furniture.

Piping / Heat insulating material

Require the following materials for piping and heat insulating at site.

Piping	Hard vinyl chloride pipe VP25 (Outer dia. : Ø32 mm)
Heat insulator	Foam polyethylene : Thickness 10 mm or more

Flexible hose

Use the attached flexible hose to adjust center discrepancy of the hard vinyl chloride pipe or to adjust the angle.

- Do not use the flexible hose as stretched, or do not deform it more extent than that in the following figure.
- Be sure to fix the soft end of the flexible hose with the attached hose band.
- Use the flexible hose on a horizontal level.

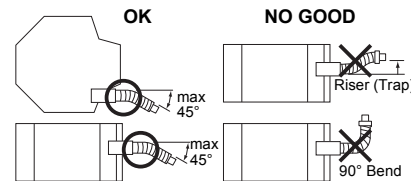

REQUIREMENT

- Be sure to perform heat insulation of the drain pipes of the indoor unit.
- Never forget to perform heat insulation of the connecting part with the indoor unit. An incomplete heat insulation causes dew dropping.
- Set the drain pipe with downward slope (1/100 or more), and do not make swelling or trap on the piping. It may cause an abnormal sound.

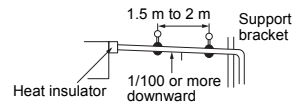

- For length of the traversing drain pipe, restrict to 20 m or less. In case of a long pipe, provide support brackets with interval of 1.5 to 2 m in order to prevent waving.

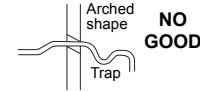

- Set the collective piping as shown in the below figure.

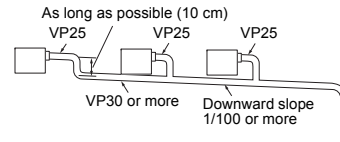

- Be sure not to apply force to the connecting part of the drain pipe.
- The hard vinyl-chloride pipe cannot be directly connected to the drain pipe connecting port of the indoor unit. For connection with the drain pipe connecting port, be sure to use / fix the attached flexible hose with the hose band, otherwise a damage or water leak is caused on the drain pipe connecting port.

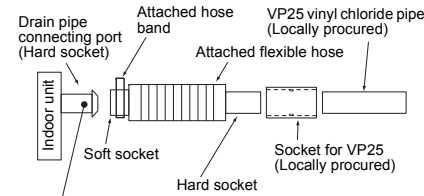

Adhesive inhibited :
Use the attached flexible hose and hose band for connecting the drain hose to the clear drain socket. If applying the adhesive, socket will be damaged and cause water leakage.

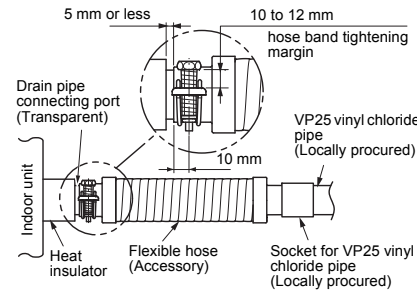

Connecting drain pipe

- Connect a hard socket (locally procured) to the hard socket of the attached supplied flexible hose.
- Connect a drain pipe (locally procured) to the connected hard socket.

REQUIREMENT

- Connect hard vinyl chloride pipes securely using an adhesive for vinyl chloride to avoid water leakage.
- It takes some time until the adhesive is dried and hardened (refer to the manual of the adhesive). Do not apply stress to the joint with the drain pipe during this time period.

Drain up

When a down-gradient cannot be secured for the drainpipe, drain-up piping is possible.

- The height of the drain pipe must be 850 mm or less from the bottom of the ceiling.
- Take the drain pipe out of the drain pipe joint with the indoor unit in 300 mm or less, and bend up the pipe vertically.
- Immediately after the pipe is bent up vertically, lay the pipe making a down-gradient.
- Set downward grading immediately after raising up vertically.

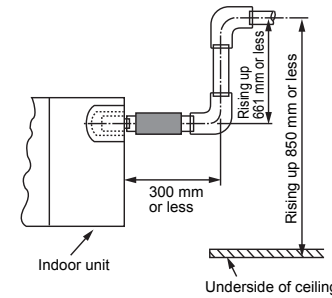

Check the draining

In the test run, check that water drain is properly performed and water does not leak from the connecting part of the pipes. Be sure to check draining also when installed in heating period.

Using a pitcher or hose, pour water (1500 to 2000 cc) into the discharge port before installation of the ceiling panel.

Pour water gradually so that water does not spread on the motor of the drain pump.

CAUTION

Pour water gently so that it does not spread around inside the indoor unit, which may cause a malfunction.

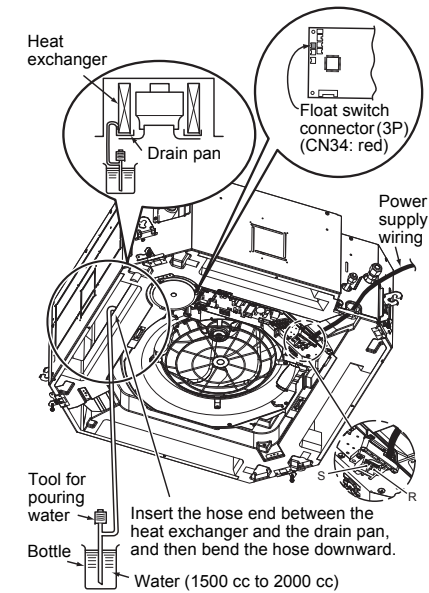

- After the electric work has finished, pour water during Cool mode operation.
- If the electric work has not yet finished, pull out the float switch connector (CN34 : Red) from the electrical control box, and check draining by plugging the single phase 220-240 V power to the terminal blocks R(L) and S(N). If doing so, the drain pump motor operates. (Never apply 220-240 V to Ⓚ, Ⓛ, ⓐ or ⓑ, otherwise a trouble of P.C. board occurs.)

- Test water drain while checking the operation sound of the drain pump motor.
(If the operation sound changes from continuous sound to intermittent sound, water is normally drained.)
After the check, the drain pump motor runs, connecting the float switch connector.
(In case of check by pulling out the float switch connector, be sure to return the connector to the original position.)

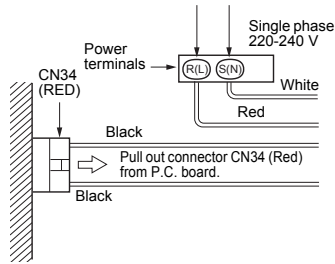

■ Heat insulating

- As shown in the figure, cover the flexible hose and hose band with the attached heat insulator up to the bottom of the indoor unit without gap.
- Cover the drain pipe seamlessly with a heat insulator locally procured so that it overlaps with the attached heat insulator of the drain connecting section.

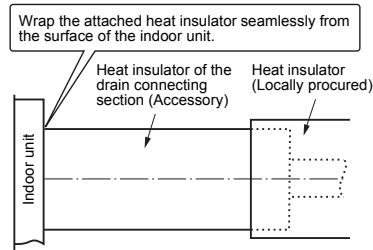

* Direct the slits and seams of the heat insulator upward to avoid water leakage.

6 Refrigerant piping

⚠ CAUTION

When the refrigerant pipe is long, provide support brackets at intervals of 2.5 m to 3 m to clamp the refrigerant pipe. Otherwise, abnormal sound may be generated.
Use the flare nut attached with the indoor unit or R410A flare nut.

■ Permissible piping length and height difference

They vary depending on the outdoor unit. For details, refer to the Installation Manual attached to the outdoor unit.

■ Pipe size

Model MMU-		AP009 to AP012	AP015 to AP018	AP024 to AP056
Pipe size (Dia. : mm)	Gas side	9.5	12.7	15.9
	Liquid side	6.4	6.4	9.5

■ Connecting refrigerant piping

Flaring

1. Cut the pipe with a pipe cutter.
Remove burrs completely. (Remaining burrs may cause gas leakage.)
2. Insert a flare nut into the pipe, and flare the pipe.
Use the flare nut provided with the unit or the one used for the R410A refrigerant. The flaring dimensions for R410A are different from the ones used for the conventional R22 refrigerant. A new flare tool manufactured for use with the R410A refrigerant is recommended, but the conventional tool can still be used if the projection margin of the copper pipe is adjusted to be as shown in the following table.

Projection margin in flaring: B (Unit: mm)

Outer dia. of copper pipe	R410A tool used	Conventional tool used
6.4, 9.5	0 to 0.5	1.0 to 1.5
12.7, 15.9		

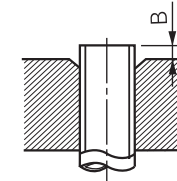

Flaring diameter size: A (Unit: mm)

Outer dia. of copper pipe	A $\begin{smallmatrix} +0 \\ -0.4 \end{smallmatrix}$
6.4	9.1
9.5	13.2
12.7	16.6
15.9	19.7

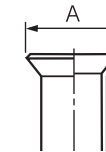

- * In case of flaring for R410A with the conventional flare tool, pull it out approx. 0.5 mm more than that for R22 to adjust to the specified flare size. The copper pipe gauge is useful for adjusting projection margin size.
- The sealed gas was sealed at the atmospheric pressure so when the flare nut is removed, there will no "whooshing" sound: This is normal and is not indicative of trouble.
- Use two wrenches to connect the indoor unit pipe.

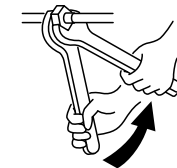

Work using double spanner

- Use the tightening torque levels as listed in the following table.

Outer dia. of connecting pipe (mm)	Tightening torque (N·m)
6.4	14 to 18 (1.4 to 1.8 kgf·m)
9.5	34 to 42 (3.4 to 4.2 kgf·m)
12.7	49 to 61 (4.9 to 6.1 kgf·m)
15.9	63 to 77 (6.3 to 7.7 kgf·m)

- Tightening torque of flare pipe connections. Pressure of R410A is higher than that of R22. (Approx. 1.6 times) Therefore, using a torque wrench, tighten the flare pipe connecting sections which connect the indoor and outdoor units of the specified tightening torque. Incorrect connections may cause not only a gas leak, but also a trouble of the refrigeration cycle.

⚠ CAUTION

Tightening with an excessive torque may crack the nut depending on installation conditions.

◆ Piping with outdoor unit

Shape of valve differs according to the outdoor unit. For details of installation, refer to the Installation Manual of the outdoor unit.

■ Airtight test / Air purge, etc.

For airtight test, air purge, addition of refrigerant, and gas leak check, refer to the Installation Manual attached to the outdoor unit.

REQUIREMENT

Do not supply power to the indoor unit until the airtight test and vacuuming are completed. (If the indoor unit is powered on, the pulse motor valve is fully closed, which extends the time for vacuuming.)

◆ Open the valve fully

Open the valve of the outdoor unit fully. For details, refer to the Installation Manual attached to the outdoor unit.

◆ Heat insulation process

Apply heat insulation for the pipes separately at liquid side and gas side.

For the heat insulation to the pipes at gas side, be sure to use the material with heat-resisting temperature 120 °C or higher.

Using the attached heat insulation material, apply the heat insulation to the pipe connecting section of the indoor unit securely without gap.

REQUIREMENT

- Apply the heat insulation to the pipe connecting section of the indoor unit securely up to the root without exposure of the pipe. (The pipe exposed to the outside causes water leak.)
- Wrap heat insulator with its slits facing up (ceiling side).

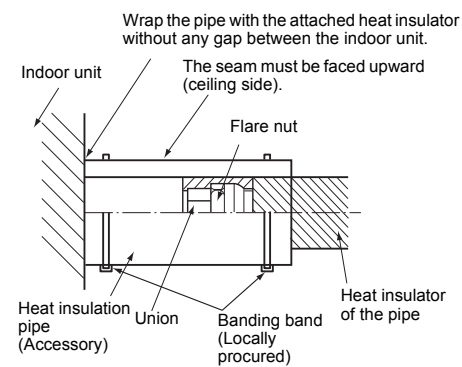

7 Electrical connection

⚠ WARNING

- Use the specified wires for wiring connect the terminals. Securely fix them to prevent external forces applied to the terminals from affecting the terminals. Incomplete connection or fixation may cause a fire or other trouble.
- Connect earth wire. (grounding work) Incomplete grounding cause an electric shock. Do not connect earth wires to gas pipes, water pipes, lightning conductor or telephone earth wires.
- Appliance shall be installed in accordance with national wiring regulations. Capacity shortage of power circuit or incomplete installation may cause an electric shock or a fire.

⚠ CAUTION

- If incorrect / incomplete wiring is carried out, it will cause an electrical fire or smoke.
- Use the cord clamps attached to the product.
- Do not damage or scratch the conductive core and inner insulator of power and system interconnection wires when peeling them.
- Use the power cord and system interconnection wire of specified thickness, type, and protective devices required.
- Do not connect 220-240 V power to the terminal blocks (U, V, A, B) for control wiring. (Otherwise, the system will fail.)
- Perform the electric wiring so that it does not come to contact with the high-temperature part of the pipe. The coating may melt resulting in an accident.

REQUIREMENT

- For power supply wiring, strictly conform to the Local Regulation in each country.
- For wiring of power supply of the outdoor units, follow the Installation Manual of each outdoor unit.
- After connecting wires to the terminal blocks, provide a trap and fix wires with the cord clamp.
- Run the refrigerant piping line and control wiring line in the same line.
- Do not turn on the power of the indoor unit until vacuuming of the refrigerant pipes completes.

■ Power supply wire and communication wires specifications

Power supply wire and communication wires are locally procured.

For the power supply specifications, follow to the table below. If capacity is little, it is dangerous because overheat or burnout may be caused.

For specifications of the power capacity of the outdoor unit and the power supply wires, refer to the Installation Manual attached to the outdoor unit.

Indoor unit power supply

- For the power supply of the indoor unit, prepare the exclusive power supply separated from that of the outdoor unit.
- Arrange the power supply, circuit breaker, and main switch of the indoor unit connected to the same outdoor unit so that they are commonly used.
- Power supply wire specification: Cable 3-core 2.5 mm², in conformity with Design 60245 IEC 57.

▼ Power supply

Power supply	220-240 V ~, 50 Hz 220 V ~, 60 Hz	
Power supply switch / circuit breaker or power supply wiring / fuse rating for indoor units should be selected by the accumulated total current values of the indoor units.		
Power supply wiring	Below 50 m	2.5 mm ²

Control wiring, Central controller wiring

- 2-core with polarity wires are used for the Control wiring between indoor unit and outdoor unit and Central controller wiring.
- To prevent noise trouble, use 2-core shield wire.
- The length of the communication line means the total length of the inter-unit wire length between indoor and outdoor units added with the central control system wire length.

▼ Communication line

Control wiring between indoor units, and outdoor unit (2-core shield wire)	Wire size	(Up to 1000 m) 1.25 mm ² (Up to 2000 m) 2.0 mm ²
Central control line wiring (2-core shield wire)	Wire size	(Up to 1000 m) 1.25 mm ² (Up to 2000 m) 2.0 mm ²

Remote controller wiring

- 2-core with non-polarity wire is used for wiring of the remote controller wiring and group remote controllers wiring.

Remote controller wiring, remote controller inter-unit wiring	Wire size: 0.5 mm ² to 2.0 mm ²	
Total wire length of remote controller wiring and remote controller inter-unit wiring = L + L1 + L2 + ... Ln	In case of wired type only	Up to 500 m
	In case of wireless type included	Up to 400 m
Total wire length of remote controller inter-unit wiring = L1 + L2 + ... Ln		Up to 200 m

⚠ CAUTION

The remote controller wire (Communication line) and AC 220-240 V wires cannot be parallel to contact each other and cannot be stored in the same conduits. If doing so, a trouble may be caused on the control system due to noise or other factor.

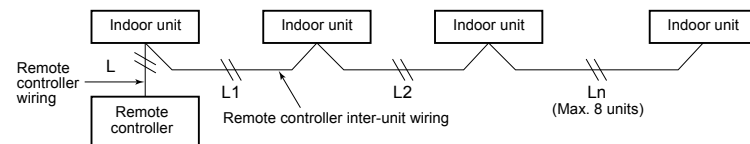

■ Wire connection

REQUIREMENT

- Be sure to connect the wires matching the terminal numbers. Incorrect connection causes a trouble.
- Be sure to pass the wires through the bushing of wiring connection port of the indoor unit.
- Keep a margin (Approx. 100 mm) on a wire to hang down the electrical control box at servicing, etc.
- The low-voltage circuit is provided for the remote controller. (Do not connect the high-voltage circuit)
- Make a loop on the wire for margin of the length so that the electrical control box can be taken out during servicing.

1. Remove the cover of the electrical control box by taking off the mounting screws (2 positions) and pushing the hooking section. (The cover of the electrical control box remains hanged to the hinge.)
2. Connect the power supply wire and remote controller wire to the terminal block of the electrical control box.
3. Tighten the screws of the terminal block, and fix the wires with cord clamp attached to the electrical control box. (Do not apply tension to the connecting section of the terminal block.)
4. Using the attached heat insulation material, seal the pipe connecting port. Otherwise, dewing may be caused.
5. Mount the cover of the electrical control box without pinching wires. (Mount the cover after wiring on the ceiling panel.)

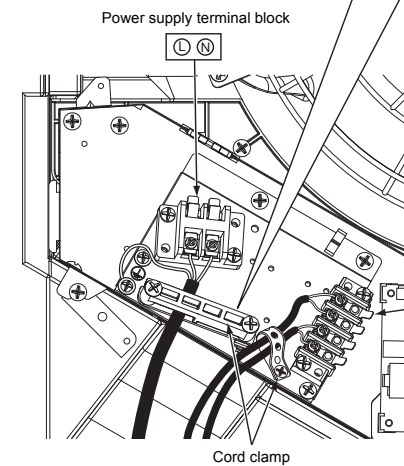
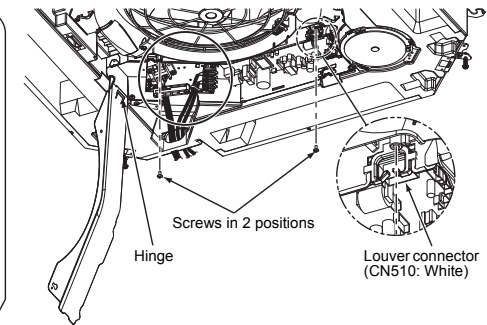
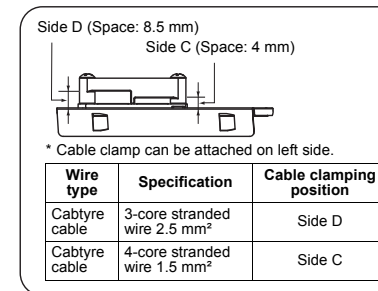

▼ Heat insulation to wiring connecting port

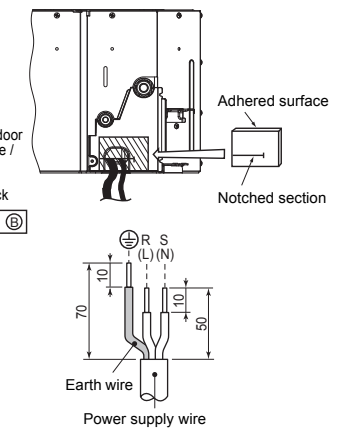

Remote controller wiring

As the remote controller wire has non-polarity, there is no problem if connections to indoor unit terminal blocks A and B are reversed.

Wiring diagram

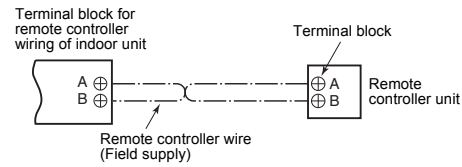

Wiring between indoor and outdoor units

NOTE

An outdoor unit connected with control wiring between indoor and outdoor units wire becomes automatically the header unit.

Wiring example

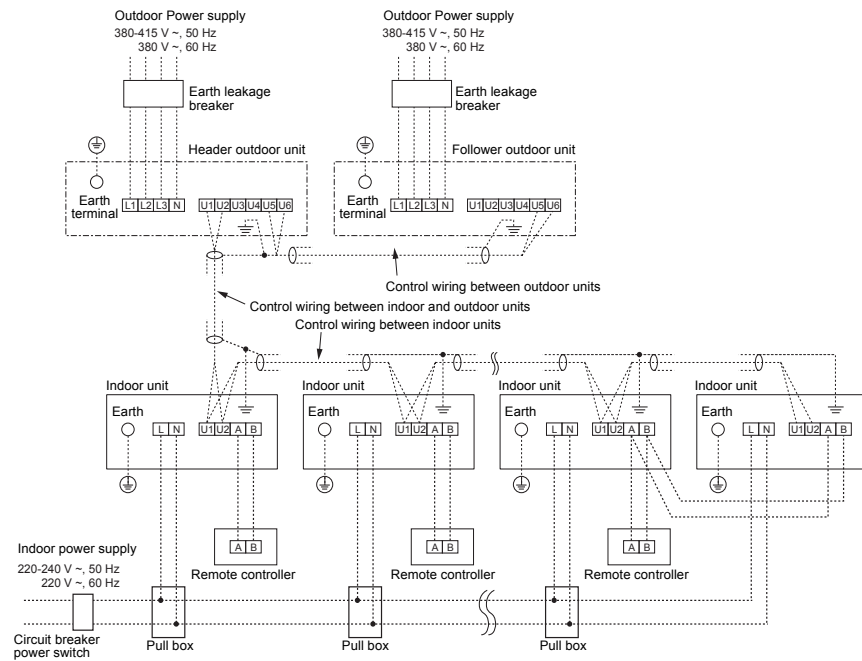

Wiring for flow selector unit (sold separately)

Connect control wiring and power supply following figure when installing a separately sold Super Heat Recovery Multi System.

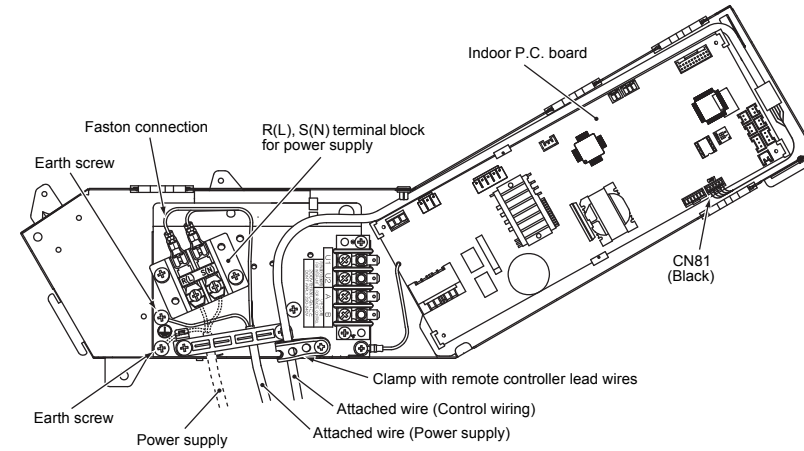

Address setup

Set up the addresses as per the Installation Manual supplied with the outdoor unit.

Wiring on the ceiling panel

According to the Installation Manual of the ceiling panel, connect the connector (20P: White) of the ceiling panel to the connector (CN510: White) on P.C. board of the electrical control box.

8 Applicable controls

REQUIREMENT

When the air conditioner is used for the first time, it will take some moments after the power has been turned on before the remote controller becomes available for operations: This is normal and is not indicative of trouble.

- Concerning the automatic addresses (The automatic addresses are set up by performing operations on the outdoor interface circuit board.)
- While the automatic addresses are being set up, no remote controller operations can be performed. Setup takes up to 10 minutes (usually about 5 minutes).
- When the power is turned on after automatic address setup

It takes up to 10 minutes (usually about 3 minutes) for the outdoor unit to start operating after the power has been turned on.

Before the air conditioner was shipped from the factory, all units are set to [STANDARD] (factory default). If necessary, change the indoor unit settings.

The settings are changed by operating the wired remote controller.

- The settings cannot be changed using only a wireless remote controller, simple remote controller or group control remote controller by itself so install a wired remote controller separately as well.

Basic procedure for changing settings

Change the settings while the air conditioner is not working. (**Stop the air conditioner before making settings.**)

CAUTION

Set only the CODE No. shown in the following table: Do NOT set any other CODE No.

If a CODE No. not listed is set, it may not be possible to operate the air conditioner or other trouble with the product may result.

- The displays appearing during the setting process differ from the ones for previous remote controllers (AMT31E). (There are more CODE No.)

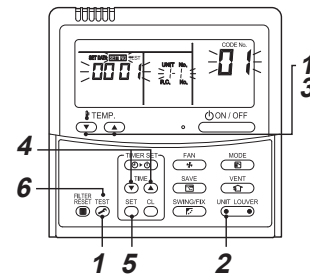

- Push and hold **TEST** button and "TEMP." button simultaneously for at least 4 seconds. After a while, the display flashes as shown in the figure. Confirm that the CODE No. is [01].

If the CODE No. is not [01], push **TEST** button to clear the display content, and repeat the procedure from the beginning. (No operation of the remote controller is accepted for a while after **TEST** button is pushed.)

(While air conditioners are operated under the group control, "ALL" is displayed first. When **UNIT LOUVER** button is pushed, the indoor unit number displayed following "ALL" is the header unit.)

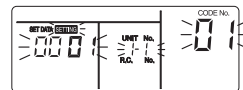

(* Display content varies with the indoor unit model.)

- Each time **UNIT LOUVER** button is pushed, indoor unit numbers in the control group change cyclically. Select the indoor unit to change settings for.

The fan of the selected unit runs and the louvers start swinging. The indoor unit for change settings can be confirmed.

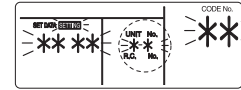

- Specify CODE No. [**] with "TEMP." button.

- Select SET DATA [****] with "TIME" button.

- Push **SET** button. When the display changes from flashing to lit, the setup is completed.

- To change settings of another indoor unit, repeat from Procedure 2.
- To change other settings of the selected indoor unit, repeat from Procedure 3.

Use **SET** button to clear the settings. To make settings after **SET** button was pushed, repeat from Procedure 2.

- When settings have been completed, push **TEST** button to determine the settings.

When **TEST** button is pushed, **SETTING** flashes and then the display content disappears and the air conditioner enters the normal stop mode. (While **SETTING** is flashing, no operation of the remote controller is accepted.)

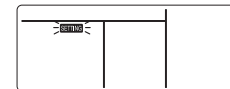

Installing indoor unit on high ceiling

When an indoor unit is installed on a ceiling higher than the standard height, make the high-ceiling setting for fan speed adjustment.

Follow to the basic operation procedure (1 → 2 → 3 → 4 → 5 → 6).

- For the CODE No. in Procedure 3, specify [5d].
- Select the SET DATA for Procedure 4 from the "Height list of ceiling possible to be installed" table in this manual.

Remote controller-less setting

Change the high-ceiling setting with the DIP switch on the receiver section P.C. board.

For details, refer to the manual of the wireless remote controller kit. The settings can also be changed with the switch on the indoor microcomputer P.C. board.

- Once the setting is changed, setting to 0001 or 0003 is possible, however setting to 0000 requires a setting data change to 0000 using the wired remote controller (separately sold) with the normal switch setting (factory default).

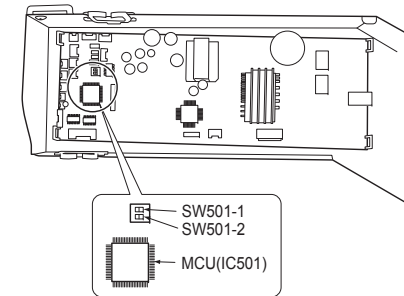

SET DATA	SW501-1	SW501-2
0000 (Factory default)	OFF	OFF
0001	ON	OFF
0003	OFF	ON

To restore the factory defaults

To return the DIP switch settings to the factory defaults, set SW501-1 and SW501-2 to OFF, connect a separately sold wired remote controller, and then set the data of CODE No. [5d] to "0000".

Change of lighting time of filter sign

According to the installation condition, the lighting time of the filter sign (Notification of filter cleaning) can be changed.

Follow the basic operation procedure (1 → 2 → 3 → 4 → 5 → 6).

- For the CODE No. in Procedure 3, specify [01].
- For the SET DATA in Procedure 4, select the SET DATA of filter sign lighting time from the following table.

SET DATA	Filter sign lighting time
0000	None
0001	150 H
0002	2500 H (Factory default)
0003	5000 H
0004	10000 H

To secure better effect of heating

When it is difficult to obtain satisfactory heating due to installation place of the indoor unit or structure of the room, the detection temperature of heating can be raised. Also use a circulator, etc. to circulate heat air near the ceiling.

Follow the basic operation procedure (1 → 2 → 3 → 4 → 5 → 6).

- For the CODE No. in Procedure 3, specify [06].
- For the SET DATA in Procedure 4, select the SET DATA of shift value of detection temperature to be set up from the table below.

SET DATA	Detection temp shift value
0000	No shift
0001	+1 °C
0002	+2 °C (Factory default)
0003	+3 °C
0004	+4 °C
0005	+5 °C
0006	+6 °C

Selecting horizontal wind direction

- Push **TEST** and "TEMP." buttons for 4 seconds or more when the air conditioner is not working. **SETTING** flashes. Indicates CODE No. [01].
- Select an indoor unit to be set by pushing **UNIT LOUVER** button (left side of the button). Indoor unit number changes each time you push the button.

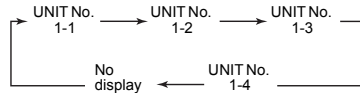

The fan of the selected unit runs and the louvers start swinging.

- Change the CODE No. to [45] with "TEMP." buttons.
- Select wind direction setting with "TIME" buttons.

Wind direction SET DATA	Wind direction setting
0000	Smudge reducing position (Air direction to reduce ceiling contamination) [Factory default]
0002	Cold draft position (Air direction to control cold air fall)

- Push **SET** button to check the setting. The display state changes from flashing to lighting, and the setting is fixed.
 - Push **TEST** button to end the setting.
- * When the cold draft position is selected, ceiling contamination is less reduced.

Selecting swing type

- Push **SWING/SET** for 4 seconds or more when the air conditioner is not working. **SETTING** flashes. Indicates CODE No. [F0].
- Select an indoor unit to be set by pushing **UNIT LOUVER** (left side of the button). Each time you push the button, unit numbers change as follows:



The fan of the selected unit runs and the louvers start swinging.

- Select a swing type by pushing "TIME" buttons.

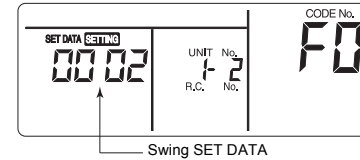

Swing SET DATA	Swing of louvers
0001	Standard swing (Factory default)
0002	Dual swing
0003	Cycle swing

CAUTION

Do not set the swing SET DATA to "0000". (This setting may cause a failure of the louvers.)

- About "Dual swing"**
"Dual" means that louvers 01 and 03 are directed and swing in one direction and louvers 02 and 04 are directed and swing in the opposite direction. (When louvers 01 and 03 are directed downward, louvers 02 and 04 are directed horizontally.)
- About "Cycle swing"**
The four louvers swing independently at respective timings.

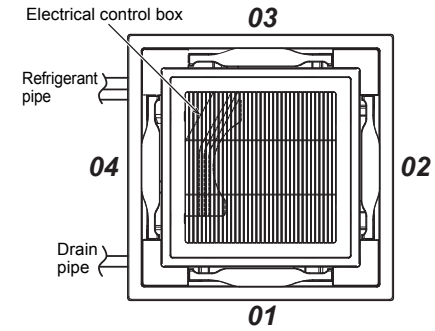

- Push **SET** button.
- Push **TEST** button to complete the setting.

■ Locking the louvers (No swing)

1. Push **UNIT LOUVER** (right side of the button) for 4 seconds or more when the air conditioner is not working. **SETTING** flashes. Indicates CODE No. [F1].
2. Select an indoor unit to be set by pushing **UNIT LOUVER** (left side of the button). Each time you push the button, unit numbers change as follows: The fan of the selected unit runs and the louvers start swinging.

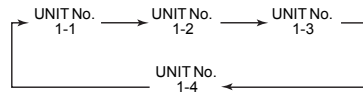

3. Select a louver you want to lock by pushing "TEMP." buttons.
4. Select the wind direction of the louver you do not want to swing by pushing "TIME" buttons.

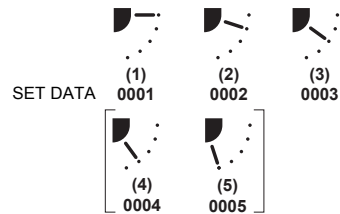

- * When (4) or (5) is selected, dew drop may occur during cooling mode.
5. Determine the setting by pushing **SET** button. When the setting has been determined, **+** lights up.
 6. Push **TEST** button to complete the setting.

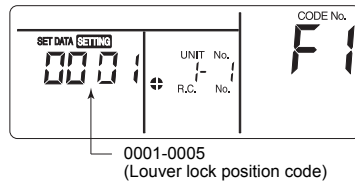

■ Cancelling louver lock

Set the wind direction to "0000" of the louver lock setup procedure above.



Setting data 0000

- When the setting is canceled, **+** goes out. **Other operations are the same as those in "Locking the louvers (No swing)".**

■ Group control

In a group control, a remote controller can control up to maximum 8 units.

- For wiring procedure and wiring method of the individual line (Identical refrigerant line) system, refer to "Electric work" in this Manual.
- Wiring between indoor units in a group is performed in the following procedure. Connect the indoor units by connecting the remote controller inter-unit wires from the remote controller terminal blocks (A/B) of the indoor unit connected with a remote controller to the remote controller terminal blocks (A/B) of the other indoor unit. (Non-polarity)
- For address setup, refer to the Installation Manual attached to the outdoor unit.

■ Remote controller sensor

The temperature sensor of the indoor unit senses room temperature usually. Set the remote controller sensor to sense the temperature around the remote controller. Select items following the basic operation procedure (1 → 2 → 3 → 4 → 5 → 6).

- Specify [32] for the CODE No. in Procedure 3.
- Select the following data for the SET DATA in Procedure 4.

SET DATA	0000	0001
Remote controller sensor	Not used (factory default)	Used

When **+** flashes, the remote controller sensor is defective.

Select the SET DATA [0000] (not used) or replace the remote controller.

9 Test run

■ Before test run

- Before turning on the power supply, carry out the following procedure.
 - 1) Using 500 V-megger, check that resistance of 1 MΩ or more exists between the terminal block of the power supply and the earth (grounding). If resistance of less than 1 MΩ is detected, do not run the unit.
 - 2) Check the valve of the outdoor unit being opened fully.
- To protect the compressor at activation time, leave power-ON for 12 hours or more before operating.
- Never press the electromagnetic contactor to forcibly perform a test run. (This is very dangerous because the protective device does not work.)
- Before starting a test run, be sure to set addresses following the installation manual supplied with the outdoor unit.

■ Executing a test run

Using the remote controller, operate the unit as usual. For the procedure of the operation, refer to the attached Owner's Manual.

A forced test run can be executed in the following procedure even if the operation stops by thermo.-OFF. In order to prevent a serial operation, the forced test run is released after 60 minutes have passed and returns to the usual operation.

⚠ CAUTION

Do not use the forced test run for cases other than the test run because it applies an excessive load to the devices.

◆ In case of wired remote controller

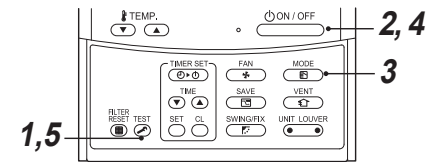

1. Keep **TEST** button pushed for 4 seconds or more. **[TEST]** is displayed on the display part and the selection of mode in the test mode is permitted.

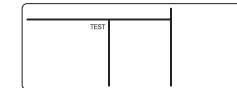

2. Push **ON/OFF** button.

3. Using **MODE** button, select the operation mode, **[Cool]** or **[Heat]**.

- Do not run the air conditioner in a mode other than **[Cool]** or **[Heat]**.
- The temperature controlling function does not work during test run.
- The detection of error is performed as usual.

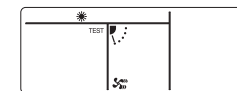

4. After the test run, push **ON/OFF** button to stop a test run. (Display part is same as procedure 1.)

5. Push **TEST** check button to cancel (release from) the test run mode. (**[TEST]** disappears on the display and the status returns to a normal.)



◆ Wireless remote controller (RBC-AX32U series)

Test run (forced cooling operation)

REQUIREMENT

Finish the forced cooling operation in a short time because it applies excessive strength to the air conditioner.

▼ How to perform forced cooling operation

1 When **TEMPORARY** button is pushed for 10 seconds or more, "Pi!" sound is heard and the operation changes to a forced cooling operation. After approx. 3 minutes, a cooling operation starts forcibly.

Check cool air starts blowing. If the operation does not start, check wiring again.

2 To stop a test operation, push **TEMPORARY** button once again (approx. 1 second).

- Check wiring / piping of the indoor and outdoor units in forced cooling operation.

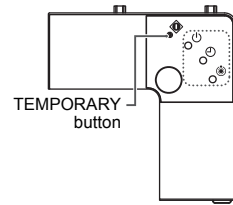

10 Maintenance

⚠ CAUTION

Before maintenance, be sure to turn off the leakage breaker.

Cleaning of air filter

- If  is displayed on the remote controller, maintain the air filter.
- Clogging of the air filter reduce cooling / heating performance.

Cleaning of panel and air filter

Preparation :

1. Turn off the air conditioner by the remote controller.
2. Open the air intake grille.
 - Slide the button of the air intake grille inward, and open the air intake grille slowly while holding it.

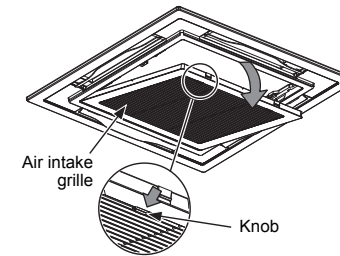

Cleaning of air filters

If the air filters are not cleaned, it not only reduce the cooling a performance of air conditioner but causes a failure in the air conditioner such as water falling in drops.

Preparation :

1. Stop the operation by remote controller.
2. Dismount the air filter.

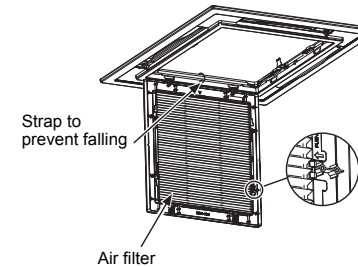

Use a vacuum cleaner to remove dust from the filters or wash them with water.

- After rinsing the air filters with water, dry them in the shade.
- Set the air filter into the air conditioner.

Clean the panel and air filter with water:

- Wipe down the panel and air filter with a sponge or towel moistened with a kitchen detergent. (Do not use any metallic brush for cleaning.)
 - Carefully rinse the panel and air filter to wash out the detergent.
 - After rinsing the panel and air filter with water, dry it in the shade.
1. Close the air intake grille.
 - Close the air intake grille, slide the knob outward, and fix the air intake grille securely.

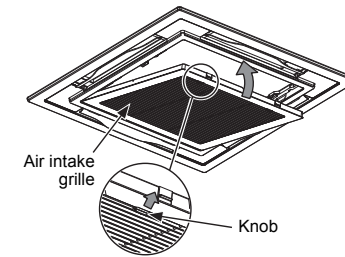

2. Push  button.
 - "FILTER " disappears.

⚠ CAUTION

- Do not start the air conditioner while leaving the panel and air filter removed.
- Push the filter reset button. ( indication will be turn off.)

Cleaning of discharge louver

The discharge louver can be removed to clean.

- Remove the discharge louver.
 - Holding the both ends of the discharge louver, remove the louver sagging the center downward.

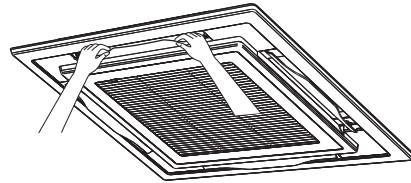

- Cleaning with water
 - If the dirt is terrible, clean the louver by tepid water with neutral detergent or water.
- Mount the discharge louver.
 - First push in one side of the louver, and then insert the other side sagging the center downward.

(1) Insert (2) Insert in the louver sagging down the center downward.

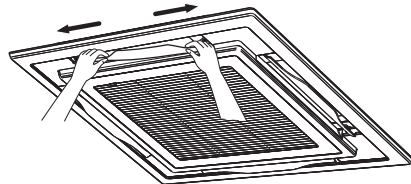

Be careful to the direction of the louver when mounting.
Mount the louver so that the side with the mark faces upward and the arrow direction of the mark directs.

REQUIREMENT

Be sure to clean the heat exchanger with pressurized water.

If a commercially available detergent (strong alkaline or acid) cleaning agent is used, the surface treatment of the heat exchanger will be marred, which may degrade the self cleaning performance.
For details, contact the dealer.

▼ Periodic Maintenance

For environmental conservation, it is strongly recommended that the indoor and outdoor units of the air conditioner in use be cleaned and maintained regularly to ensure efficient operation of the air conditioner.

When the air conditioner is operated for a long time, periodic maintenance (once a year) is recommended. Furthermore, regularly check the outdoor unit for rust and scratches, and remove them or apply rustproof treatment, if necessary.

As a general rule, when an indoor unit is operated for 8 hours or more daily, clean the indoor unit and outdoor unit at least once every 3 months. Ask a professional for this cleaning / maintenance work.

Such maintenance can extend the life of the product though it involves the owner's expense.

Failure to clean the indoor and outdoor units regularly will result in poor performance, freezing, water leakage, and even compressor failure.

Inspection before maintenance

Following inspection must be carried out by a qualified installer or qualified service person.

Parts	Inspection method
Heat exchanger	Access from inspection opening and remove the access panel. Examine the heat exchanger if there is any clogging or damages.
Fan motor	Access from inspection opening and check if any abnormal noise can be heard.
Fan	Access from inspection opening and remove the access panel. Examine the fan if there are any waggles, damages or adhesive dust.
Filter	Go to installed location and check if there are any stains or breaks on the filter.
Drain pan	Access from inspection opening and remove the access panel. Check if there is any clogging or drain water is polluted.

▼ Maintenance List

Part	Unit	Check (visual / auditory)	Maintenance
Heat exchanger	Indoor / outdoor	Dust / dirt clogging, scratches	Wash the heat exchanger when it is clogged.
Fan motor	Indoor / outdoor	Sound	Take appropriate measures when abnormal sound is generated.
Filter	Indoor	Dust / dirt, breakage	<ul style="list-style-type: none"> Wash the filter with water when it is contaminated. Replace it when it is damaged.
Fan	Indoor	<ul style="list-style-type: none"> Vibration, balance Dust / dirt, appearance 	<ul style="list-style-type: none"> Replace the fan when vibration or balance is terrible. Brush or wash the fan when it is contaminated.
Air intake / discharge grilles	Indoor / outdoor	Dust / dirt, scratches	Fix or replace them when they are deformed or damaged.
Drain pan	Indoor	Dust / dirt clogging, drain contamination	Clean the drain pan and check the downward slope for smooth drainage.
Ornamental panel, louvres	Indoor	Dust / dirt, scratches	Wash them when they are contaminated or apply repair coating.
Exterior	Outdoor	<ul style="list-style-type: none"> Rust, peeling of insulator Peeling / lift of coat 	Apply repair coating.

11 Troubleshooting

Confirmation and check

When an error occurred in the air conditioner, the check code and the indoor unit No. appear on the display part of the remote controller.

The check code is only displayed during the operation. If the display disappears, operate the air conditioner according to the following "Confirmation of error log" for confirmation.

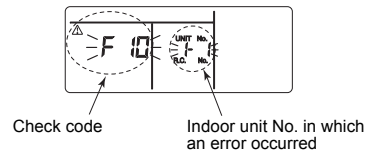

Check code

Indoor unit No. in which an error occurred

Confirmation of error log

When an error occurred on the air conditioner, the error log can be confirmed with the following procedure.

(The error log is stored in memory up to 4 errors.)

The log can be confirmed from both operating status and stop status.

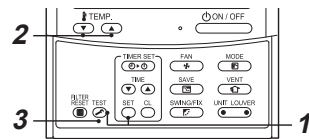

1 When pushing **SET** and **TEST** buttons for 4 seconds or more, following display appears.

If [Service check] is displayed, the mode enters in the error log mode.

- [01 : Order of error log] is displayed in CODE No. window.
- [Check code] is displayed in CHECK window.
- [Indoor unit address in which an error occurred] is displayed in Unit No.

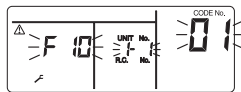

2 Every pushing of "TEMP." button used to set temperature, the error log stored in memory is displayed in order.

The numbers in CODE No. indicate CODE No. [01] (latest) → [04] (oldest).

REQUIREMENT

Do not push **CL** button because all the error log of the indoor unit will be deleted.

3 After confirmation, push **TEST** button to return to the usual display.

Check method

On the wired remote controller, central control remote controller and the interface P.C. board of the outdoor unit (I/F), a check display LCD (Remote controller) or 7-segment display (on the outdoor interface P.C. board) to display the operation is provided. Therefore the operation status can be known. Using this self-diagnosis function, a trouble or position with error of the air conditioner can be found as shown in the table below.

Check code list

The following list shows each check code. Find the check contents from the list according to part to be checked.

- In case of check from indoor remote controller: See "Wired remote controller display" in the list.
- In case of check from outdoor unit: See "Outdoor unit 7-segment display" in the list.
- In case of check from AI-NET central control remote controller: See "AI-NET central control display" in the list.
- In case of check from indoor unit with a wireless remote controller: See "Sensor block display of receiving unit" in the list.

○: Lighting, ◻: Flashing, ●: Goes off
AI-NET: Artificial Intelligence

IPDU: Intelligent Power Drive Unit

ALT: Flashing is alternately when there are two flashing LED.

SIM: Simultaneous flashing when there are two flashing LED.

Wired remote controller display	Check code			Wireless remote controller				Check code name	Judging device
	Outdoor unit 7-segment display	AI-NET central control display	Auxiliary code	Sensor block display of receiving unit					
				Operation	Timer	Ready	Flash		
E01	—	—	—	◻	●	●		Communication error between indoor unit and remote controller (Detected at remote controller side)	Remote controller
E02	—	—	—	◻	●	●		Remote controller transmission error	Remote controller
E03	—	—	97	◻	●	●		Communication error between indoor unit and remote controller (Detected at indoor unit side)	Indoor unit
E04	—	—	04	●	●	◻		Communication circuit error between indoor / outdoor unit (Detected at indoor unit side)	Indoor unit
E06	E06	No. of indoor units in which sensor has been normally received	04	●	●	◻		Decrease of No. of indoor units	I/F
—	E07	—	—	●	●	◻		Communication circuit error between indoor / outdoor unit (Detected at outdoor unit side)	I/F
E08	E08	Duplicated indoor unit addresses	96	◻	●	●		Duplicated indoor unit addresses	Indoor unit • I/F
E09	—	—	99	◻	●	●		Duplicated master remote controllers	Remote controller
E10	—	—	CF	◻	●	●		Communication error between indoor unit MC	Indoor unit
E12	E12	01:Indoor / Outdoor units communication 02:Outdoor / Outdoor units communication	42	◻	●	●		Automatic address start error	I/F
E15	E15	—	42	●	●	◻		No indoor unit during automatic addressing	I/F
E16	E16	00:Capacity over 01 ~:No. of connected units	89	●	●	◻		Capacity over / No. of connected indoor units	I/F
E18	—	—	97, 99	◻	●	●		Communication error between header and follower units Indoor unit	Indoor unit
E19	E19	00:No header 02:Two or more header units	96	●	●	◻		Outdoor header units quantity error	I/F
E20	E20	01:Outdoor unit of other line connected 02:Indoor unit of other line connected	42	●	●	◻		Other line connected during automatic address	I/F
E21	E21	02:No header unit 00:Multiple number of header units	42	●	●	◻		Error in number of heat storage master units	I/F
E22	E22	—	42	●	●	◻		Reduction in number of heat storage units	I/F
E23	E23	—	15	●	●	◻		Sending error in communication between outdoor units Error in number of heat storage units (trouble with reception)	I/F
E25	E25	—	15	●	●	◻		Duplicated follower outdoor addresses	I/F
E26	E26	No. of outdoor units which received signal normally	15	●	●	◻		Decrease of No. of connected outdoor units	I/F
E28	E28	Detected outdoor unit number	d2	●	●	◻		Follower outdoor unit error	I/F
E31	E31	Number of IPDU (*1)	CF	●	●	◻		IPDU communication error	I/F

Wired remote controller display	Check code			Wireless remote controller				Check code name	Judging device
	Outdoor unit 7-segment display		AI-NET central control display	Sensor block display of receiving unit					
		Auxiliary code		Operation	Timer	Ready	Flash		
F01	—	—	0F	☐	☐	●	ALT	Indoor unit TCJ sensor error	Indoor unit
F02	—	—	0d	☐	☐	●	ALT	Indoor unit TC2 sensor error	Indoor unit
F03	—	—	93	☐	☐	●	ALT	Indoor unit TC1 sensor error	Indoor unit
F04	F04	—	19	☐	☐	○	ALT	TD1 sensor error	I/F
F05	F05	—	A1	☐	☐	○	ALT	TD2 sensor error	I/F
F06	F06	01:TE1 sensor 02:TE2 sensor	18	☐	☐	○	ALT	TE1 sensor error TE2 sensor error	I/F
F07	F07	—	18	☐	☐	○	ALT	TL sensor error	I/F
F08	F08	—	1b	☐	☐	○	ALT	TO sensor error	I/F
F10	—	—	OC	☐	☐	●	ALT	Indoor unit TA sensor error	Indoor unit
F12	F12	—	A2	☐	☐	○	ALT	TS1 sensor error	I/F
F13	F13	01:Comp. 1 side 02:Comp. 2 side 03:Comp. 3 side	43	☐	☐	○	ALT	TH sensor error	IPDU
F15	F15	—	18	☐	☐	○	ALT	Outdoor unit temp. sensor miscabling (TE, TL)	I/F
F16	F16	—	43	☐	☐	○	ALT	Outdoor unit pressure sensor miscabling (Pd, Ps)	I/F
F22	F22	—	B2	☐	☐	○	ALT	TD3 sensor error	I/F
F23	F23	—	43	☐	☐	○	ALT	Ps sensor error	I/F
F24	F24	—	43	☐	☐	○	ALT	Pd sensor error	I/F
F29	—	—	12	☐	☐	●	SIM	Indoor unit other error	Indoor unit
F31	F31	—	1C	☐	☐	○	SIM	Indoor unit EEPROM error	I/F
H01	H01	01:Comp. 1 side 02:Comp. 2 side 03:Comp. 3 side	IF	●	☐	●		Compressor break down	IPDU
H02	H02	01:Comp. 1 side 02:Comp. 2 side 03:Comp. 3 side	1d	●	☐	●		Compressor trouble (lock)	IPDU
H03	H03	01:Comp. 1 side 02:Comp. 2 side 03:Comp. 3 side	17	●	☐	●		Current detect circuit system error	IPDU
H04	H04	—	44	●	☐	●		Comp. 1 case thermo operation	I/F
H05	H05	—	—	●	☐	●		TD1 sensor miswiring	I/F
H06	H06	—	20	●	☐	●		Low pressure protective operation	I/F
H07	H07	—	d7	●	☐	●		Oil level down detective protection	I/F
H08	H08	01:TK1 sensor error 02:TK2 sensor error 03:TK3 sensor error 04:TK4 sensor error 05:TK5 sensor error	d4	●	☐	●		Oil level detective temp sensor error	I/F
H14	H14	—	44	●	☐	●		Comp. 2 case thermo operation	I/F
H15	H15	—	—	●	☐	●		TD2 sensor miswiring	I/F
H16	H16	01:TK1 oil circuit system error 02:TK2 oil circuit system error 03:TK3 oil circuit system error 04:TK4 oil circuit system error 05:TK5 oil circuit system error	d7	●	☐	●		Oil level detective circuit error	I/F
H25	H25	—	—	●	☐	●		TD3 sensor miswiring	I/F
L03	—	—	96	☐	●	☐	SIM	Indoor unit centre unit duplicated	Indoor unit

Wired remote controller display	Check code			Wireless remote controller				Check code name	Judging device
	Outdoor unit 7-segment display		AI-NET central control display	Sensor block display of receiving unit					
		Auxiliary code		Operation	Timer	Ready	Flash		
L04	L04	—	96	□	○	□	SIM	Outdoor unit line address duplicated	I/F
L05	—	—	96	□	●	□	SIM	Duplicated indoor units with priority (Displayed in indoor unit with priority)	I/F
L06	L06	No. of indoor units with priority	96	□	●	□	SIM	Duplicated indoor units with priority (Displayed in unit other than indoor unit with priority)	I/F
L07	—	—	99	□	●	□	SIM	Group line in individual indoor unit	Indoor unit
L08	L08	—	99	□	●	□	SIM	Indoor unit group / Address unset	Indoor unit, I/F
L09	—	—	46	□	●	□	SIM	Indoor unit capacity unset	Indoor unit
L10	L10	—	88	□	○	□	SIM	Outdoor unit capacity unset	I/F
L17	—	—	46	□	○	□	SIM	Outdoor unit type mismatch error	I/F
L20	—	—	98	□	○	□	SIM	Duplicated central control addresses	AI-NET, Indoor unit
L26	L26	Number of heat storage units connected	46	□	○	□	SIM	Too many heat storage units connected	I/F
L27	L27	Number of heat storage units connected	46	□	○	□	SIM	Error in number of heat storage units connected	I/F
L28	L28	—	46	□	○	□	SIM	Too many outdoor units connected	I/F
L29	L29	Number of IPDU (*1)	CF	□	○	□	SIM	No. of IPDU error	I/F
L30	L30	Detected indoor unit address	b6	□	○	□	SIM	Indoor unit outside interlock	Indoor unit
—	L31	—	—	—	—	—	—	Extended I/C error	I/F
P01	—	—	11	●	□	□	ALT	Indoor fan motor error	Indoor unit
P03	P03	—	1E	□	●	□	ALT	Discharge temp. TD1 error	I/F
P04	P04	01:Comp. 1 side 02:Comp. 2 side 03:Comp. 3 side	21	□	●	□	ALT	High-pressure SW system operation	IPDU
P05	P05	00: 01:Comp. 1 side 02:Comp. 2 side 03:Comp. 3 side	AF	□	●	□	ALT	Phase missing detection / Power failure detection Inverter DC voltage error (comp.) Inverter DC voltage error (comp.) Inverter DC voltage error (comp.)	I/F
P07	P07	01:Comp. 1 side 02:Comp. 2 side 03:Comp. 3 side	IC	□	●	□	ALT	Heat sink overheat error	IPDU, I/F
P09	P09	Detected heat storage address	47	●	□	□	ALT	No heat storage unit water error	Heat storage unit
P10	P10	Detected indoor unit address	Ob	●	□	□	ALT	Indoor unit overflow error	Indoor unit
P12	—	—	11	●	□	□	ALT	Indoor unit fan motor error	Indoor unit
P13	P13	—	47	●	□	□	ALT	Outdoor liquid back detection error	I/F
P15	P15	01:TS condition 02:TD condition	AE	□	●	□	ALT	Gas leak detection	I/F
P17	P17	—	bb	□	●	□	ALT	Discharge temp. TD2 error	I/F
P18	P18	—	E2	□	●	□	ALT	Discharge temp. TD3 error	I/F
P19	P19	Detected outdoor unit number	O8	□	●	□	ALT	4-way valve inverse error	I/F
P20	P20	—	22	□	●	□	ALT	High-pressure protective operation	I/F
P22	P22	0*:IGBT circuit 1*:Position detective circuit error 3*:Motor lock error 4*:Motor current detection C*:TH sensor error D*:TH sensor error E*:Inverter DC voltage error (outdoor unit fan)	1A	□	●	□	ALT	Outdoor unit fan IPDU error Note: Ignore 0 to F displayed in "*" position.	IPDU
P26	P26	01:Comp. 1 side 02:Comp. 2 side 03:Comp. 3 side	14	□	●	□	ALT	G-TR short protection error	IPDU

Wired remote controller display	Check code			Wireless remote controller				Check code name	Judging device
	Outdoor unit 7-segment display	AI-NET central control display	Sensor block display of receiving unit	Sensor block display of receiving unit					
				Operation	Timer	Ready	Flash		
P29	P29	01:Comp. 1 side 02:Comp. 2 side 03:Comp. 3 side	16	□	●	□	ALT	Comp. position detective circuit system error	IPDU
P31	—	—	47	□	●	□	ALT	Other indoor unit error (Group follower indoor unit error)	Indoor unit
—	—	—	b7	By alarm device			ALT	Error in indoor unit group	AI-NET
—	—	—	97	—			—	AI-NET communication system error	AI-NET
—	—	—	99	—			—	Duplicated network adapters	AI-NET

*1 Number of IPDU

01: Comp. 1
02: Comp. 2
03: Comp. 1 + Comp. 2
04: Comp. 3

05: Comp. 1 + Comp. 3
06: Comp. 2 + Comp. 3
07: Comp. 1 + Comp. 2 + Comp. 3
08: Fan

09: Comp. 1 + Fan
0A: Comp. 2 + Fan
0B: Comp. 1 + Comp. 2 + Fan
0C: Comp. 3 + Fan

0D: Comp. 1 + Comp. 3 + Fan
0E: Comp. 2 + Comp. 3 + Fan
0F: Comp. 1 + Comp. 2 + Comp. 3 + Fan

Error detected by TCC-LINK central control device

Central control device indication	Check code			Wireless remote controller				Check code name	Judging device
	Outdoor unit 7-segment display	AI-NET central control display	Sensor block display of receiving unit	Sensor block display of receiving unit					
				Operation	Timer	Ready	Flash		
C05	—	—	—	—				Sending error in TCC-LINK central control device	TCC-LINK
C06	—	—	—	—				Receiving error in TCC-LINK central control device	TCC-LINK
C12	—	—	—	—				Batch alarm of general-purpose equipment control interface	General-purpose equipment, I/F
P30	Differs according to error contents of unit with occurrence of alarm			—				Group control follower unit error	TCC-LINK
	—	—	—	(L20 is displayed.)				Decrease of No. of indoor units	

TCC-LINK: TOSHIBA Carrier Communication Link.

12 Specifications

Model	Sound power level (dBA)		Weight (kg) Main unit (Ceiling panel)
	Cooling	Heating	
MMU-AP0094HP-E	*	*	18 (4)
MMU-AP0124HP-E	*	*	18 (4)
MMU-AP0154HP-E	*	*	20 (4)
MMU-AP0184HP-E	*	*	20 (4)
MMU-AP0244HP-E	*	*	20 (4)
MMU-AP0274HP-E	*	*	20 (4)
MMU-AP0304HP-E	*	*	20 (4)
MMU-AP0364HP-E	*	*	25 (4)
MMU-AP0484HP-E	*	*	25 (4)
MMU-AP0564HP-E	*	*	25 (4)

* Under 70 dBA

Declaration of Conformity

Manufacturer: **TOSHIBA CARRIER (THAILAND) CO., LTD.**
144 / 9 Moo 5, Bangkadi Industrial Park, Tivanon Road,
Amphur Muang, Pathumthani 12000, Thailand

Authorized Representative / TCF holder: Nick Ball
Toshiba EMEA Engineering Director
Toshiba Carrier UK Ltd.
Porsham Close, Belliver Industrial Estate,
PLYMOUTH, Devon, PL6 7DB.
United Kingdom

Hereby declares that the machinery described below:

Generic Denomination: Air Conditioner

Model / type: MMU-AP0094HP-E, MMU-AP0124HP-E, MMU-AP0154HP-E, MMU-AP0184HP-E,
MMU-AP0244HP-E, MMU-AP0274HP-E, MMU-AP0304HP-E, MMU-AP0364HP-E,
MMU-AP0484HP-E, MMU-AP0564HP-E

Commercial name: Super Modular Multi System Air Conditioner
Super Heat Recovery Multi System Air Conditioner
Mini-Super Modular Multi System Air Conditioner (MiNi-SMMS series)

Complies with the provisions of the "Machinery" Directive (Directive 2006/42/EC) and the regulations transposing into national law

Complies with the provisions of the following harmonized standard:
EN 378-2: 2008+A2: 2012

NOTE

This declaration becomes invalid if technical or operational modifications are introduced without the manufacturer's consent.

Warnings on Refrigerant Leakage

Check of Concentration Limit

The room in which the air conditioner is to be installed requires a design that in the event of refrigerant gas leaking out, its concentration will not exceed a set limit.

The refrigerant R410A which is used in the air conditioner is safe, without the toxicity or combustibility of ammonia, and is not restricted by laws to be imposed which protect the ozone layer. However, since it contains more than air, it poses the risk of suffocation if its concentration should rise excessively. Suffocation from leakage of R410A is almost non-existent. With the recent increase in the number of high concentration buildings, however, the installation of multi air conditioner systems is on the increase because of the need for effective use of floor space, individual control, energy conservation by curtailing heat and carrying power etc.

Most importantly, the multi air conditioner system is able to replenish a large amount of refrigerant compared with conventional individual air conditioners. If a single unit of the multi conditioner system is to be installed in a small room, select a suitable model and installation procedure so that if the refrigerant accidentally leaks out, its concentration does not reach the limit (and in the event of an emergency, measures can be made before injury can occur).

In a room where the concentration may exceed the limit, create an opening with adjacent rooms, or install mechanical ventilation combined with a gas leak detection device. The concentration is as given below.

$$\frac{\text{Total amount of refrigerant (kg)}}{\text{Min. volume of the indoor unit installed room (m}^3\text{)}} \leq \text{Concentration limit (kg/m}^3\text{)}$$

The concentration limit of R410A which is used in multi air conditioners is 0.3 kg/m³.

▼ NOTE 1

If there are 2 or more refrigerating systems in a single refrigerating device, the amounts of refrigerant should be as charged in each independent device.

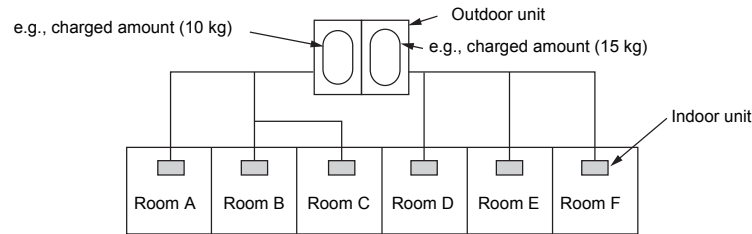

For the amount of charge in this example:

The possible amount of leaked refrigerant gas in rooms A, B and C is 10 kg.

The possible amount of leaked refrigerant gas in rooms D, E and F is 15 kg.

▼ NOTE 2

The standards for minimum room volume are as follows.

- 1) No partition (shaded portion)

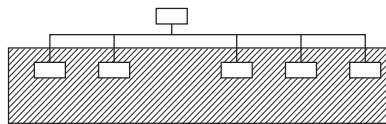

Important

- 2) When there is an effective opening with the adjacent room for ventilation of leaking refrigerant gas (opening without a door, or an opening 0.15 % or larger than the respective floor spaces at the top or bottom of the door).

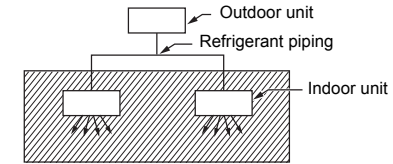

- 3) If an indoor unit is installed in each partitioned room and the refrigerant piping is interconnected, the smallest room of course becomes the object. But when a mechanical ventilation is installed interlocked with a gas leakage detector in the smallest room where the density limit is exceeded, the volume of the next smallest room becomes the object.

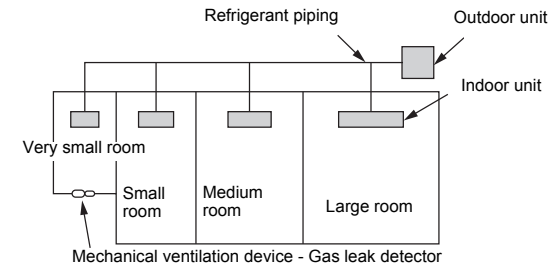

▼ NOTE 3

The minimum indoor floor area compared with the amount of refrigerant is roughly as follows: (When the ceiling is 2.7 m high)

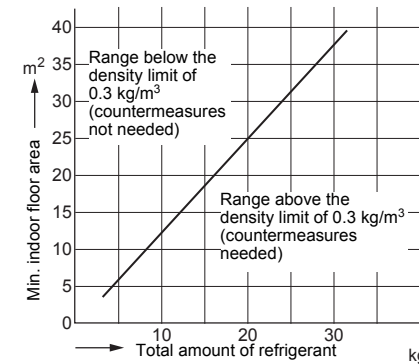

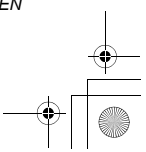
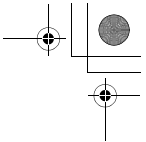

Confirmation of indoor unit setup

Prior to delivery to the customer, check the address and setup of the indoor unit, which has been installed in this time and fill the check sheet (Table below). Data of four units can be entered in this check sheet. Copy this sheet according to the No. of the indoor units. If the installed system is a group control system, use this sheet by entering each line system into each installation manual attached to the other indoor units.

REQUIREMENT

This check sheet is required for maintenance after installation. Fill this sheet and then pass this Installation Manual to the customers.

Indoor unit setup check sheet

Indoor unit		Indoor unit		Indoor unit		Indoor unit	
Room name	Room name	Room name	Room name	Room name	Room name	Room name	Room name
Model	Model	Model	Model	Model	Model	Model	Model
Check indoor unit address. (For check method, refer to APPLICABLE CONTROLS in this manual.)							
*In case of a single system, it is unnecessary to enter the indoor address. (CODE NO.: Line [12], Indoor [13], Group [14], Central control [03])							
Line	Indoor	Group	Line	Indoor	Group	Line	Indoor
Central control address		Central control address		Central control address		Central control address	
Various setup		Various setup		Various setup		Various setup	

Have you changed high ceiling setup? If not, fill check mark [x] in [NO CHANGE], and fill check mark [x] in [ITEM] if changed, respectively. (For check method, refer to APPLICABLE CONTROLS in this manual.) * In case of replacement of jumper blocks on indoor microcomputer P.C. board, setup is automatically changed.

High ceiling setup (CODE NO. [5d])	High ceiling setup (CODE NO. [5d])	High ceiling setup (CODE NO. [5d])	High ceiling setup (CODE NO. [5d])
<input type="checkbox"/> NO CHANGE	<input type="checkbox"/> NO CHANGE	<input type="checkbox"/> NO CHANGE	<input type="checkbox"/> NO CHANGE
<input type="checkbox"/> STANDARD	<input type="checkbox"/> STANDARD	<input type="checkbox"/> STANDARD	<input type="checkbox"/> STANDARD
<input type="checkbox"/> HIGH CEILING 1	<input type="checkbox"/> HIGH CEILING 1	<input type="checkbox"/> HIGH CEILING 1	<input type="checkbox"/> HIGH CEILING 1
<input type="checkbox"/> HIGH CEILING 3	<input type="checkbox"/> HIGH CEILING 3	<input type="checkbox"/> HIGH CEILING 3	<input type="checkbox"/> HIGH CEILING 3

Have you changed lighting time of filter sign? If not, fill check mark [x] in [NO CHANGE], and fill check mark [x] in [ITEM] if changed, respectively. (For check method, refer to APPLICABLE CONTROLS in this manual.)

Filter sign lighting time (CODE NO. [01])	Filter sign lighting time (CODE NO. [01])	Filter sign lighting time (CODE NO. [01])	Filter sign lighting time (CODE NO. [01])
<input type="checkbox"/> NO CHANGE	<input type="checkbox"/> NO CHANGE	<input type="checkbox"/> NO CHANGE	<input type="checkbox"/> NO CHANGE
<input type="checkbox"/> NONE	<input type="checkbox"/> NONE	<input type="checkbox"/> NONE	<input type="checkbox"/> NONE
<input type="checkbox"/> 150H	<input type="checkbox"/> 150H	<input type="checkbox"/> 150H	<input type="checkbox"/> 150H
<input type="checkbox"/> 2500H	<input type="checkbox"/> 2500H	<input type="checkbox"/> 2500H	<input type="checkbox"/> 2500H
<input type="checkbox"/> 5000H	<input type="checkbox"/> 5000H	<input type="checkbox"/> 5000H	<input type="checkbox"/> 5000H
<input type="checkbox"/> 10000H	<input type="checkbox"/> 10000H	<input type="checkbox"/> 10000H	<input type="checkbox"/> 10000H

Have you changed detected temp. shift value? If not, fill check mark [x] in [NO CHANGE], and fill check mark [x] in [ITEM] if changed, respectively. (For check method, refer to APPLICABLE CONTROLS in this manual.)

Detected temp. shift value setup (CODE NO. [06])	Detected temp. shift value setup (CODE NO. [06])	Detected temp. shift value setup (CODE NO. [06])	Detected temp. shift value setup (CODE NO. [06])
<input type="checkbox"/> NO CHANGE	<input type="checkbox"/> NO CHANGE	<input type="checkbox"/> NO CHANGE	<input type="checkbox"/> NO CHANGE
<input type="checkbox"/> NO SHIFT	<input type="checkbox"/> NO SHIFT	<input type="checkbox"/> NO SHIFT	<input type="checkbox"/> NO SHIFT
<input type="checkbox"/> +1°C	<input type="checkbox"/> +1°C	<input type="checkbox"/> +1°C	<input type="checkbox"/> +1°C
<input type="checkbox"/> +2°C	<input type="checkbox"/> +2°C	<input type="checkbox"/> +2°C	<input type="checkbox"/> +2°C
<input type="checkbox"/> +3°C	<input type="checkbox"/> +3°C	<input type="checkbox"/> +3°C	<input type="checkbox"/> +3°C
<input type="checkbox"/> +4°C	<input type="checkbox"/> +4°C	<input type="checkbox"/> +4°C	<input type="checkbox"/> +4°C
<input type="checkbox"/> +5°C	<input type="checkbox"/> +5°C	<input type="checkbox"/> +5°C	<input type="checkbox"/> +5°C
<input type="checkbox"/> +6°C	<input type="checkbox"/> +6°C	<input type="checkbox"/> +6°C	<input type="checkbox"/> +6°C

Have you incorporated the following parts sold separately? If incorporated, fill check mark [x] in each [ITEM]. (When incorporating, the setup change is necessary in some cases. For setup change method, refer to Installation Manual attached to each part sold separately.)

Incorporation of parts sold separately	Incorporation of parts sold separately	Incorporation of parts sold separately	Incorporation of parts sold separately
<input type="checkbox"/> Others ()	<input type="checkbox"/> Others ()	<input type="checkbox"/> Others ()	<input type="checkbox"/> Others ()
<input type="checkbox"/> Others ()	<input type="checkbox"/> Others ()	<input type="checkbox"/> Others ()	<input type="checkbox"/> Others ()

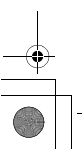
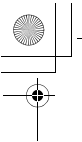

TOSHIBA CARRIER (THAILAND) CO.,LTD.

**144/9 MOO 5, BANGKADI INDUSTRIAL PARK, TIVANON ROAD, TAMBOL BANGKADI,
AMPHUR MUANG, PATHUMTHANI 12000, THAILAND.**

1114119501