

# TOSHIBA

Leading Innovation >>>

## AIR CONDITIONER (MULTI TYPE) Installation Manual

---

### Air to Air Heat Exchanger with DX Coil Unit

Model name: \_\_\_\_\_

Model with a humidifier

**MMD-VNK502HEXE**  
**MMD-VNK802HEXE**  
**MMD-VNK1002HEXE**  
**MMD-VNK1002HEXE2**

Model without a humidifier

**MMD-VN502HEXE**  
**MMD-VN802HEXE**  
**MMD-VN1002HEXE**  
**MMD-VN1002HEXE2**

For commercial use

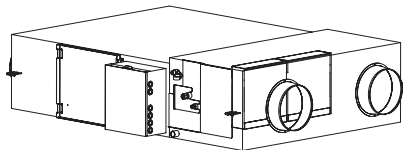

**Original instruction**

Please read this Installation Manual carefully before installing the Air to Air Heat Exchanger with DX Coil Unit.

- This Manual describes the installation method of the Air to Air Heat Exchanger with DX Coil Unit.
- For installation of the outdoor unit, follow the Installation Manual attached to the outdoor unit.

**ADOPTION OF NEW REFRIGERANT**

This Air Conditioner is a new type which adopts a new refrigerant HFC (R410A) instead of the conventional refrigerant R22 in order to prevent destruction of the ozone layer.

# Contents

<b>1</b>	<b>Precautions for Safety</b> .....	<b>2</b>
<b>2</b>	<b>Accessory Parts</b> .....	<b>4</b>
<b>3</b>	<b>Restrictions on System Construction</b> .....	<b>5</b>
<b>4</b>	<b>Selection of Installation Place</b> .....	<b>5</b>
<b>5</b>	<b>Installation of Indoor Unit</b> .....	<b>6</b>
<b>6</b>	<b>Drain Piping Work</b> .....	<b>8</b>
<b>7</b>	<b>Water Supply Piping for a Humidifier (VNK type only)</b> .....	<b>8</b>
<b>8</b>	<b>Installation of Ducts</b> .....	<b>9</b>
<b>9</b>	<b>Refrigerant Piping and Vacuuming</b> .....	<b>9</b>
<b>10</b>	<b>Electric Wiring</b> .....	<b>11</b>
<b>11</b>	<b>System Configuration</b> .....	<b>14</b>
<b>12</b>	<b>Advanced System</b> .....	<b>16</b>
<b>13</b>	<b>Advanced Control</b> .....	<b>18</b>
<b>14</b>	<b>Fan Characteristics</b> .....	<b>22</b>
<b>15</b>	<b>Test Run</b> .....	<b>24</b>
<b>16</b>	<b>Maintenance</b> .....	<b>25</b>
<b>17</b>	<b>Troubleshooting</b> .....	<b>28</b>

Thank you for purchasing this Toshiba Air to Air Heat Exchanger with DX Coil Unit. This Installation Manual describes the installation method of the Air to Air Heat Exchanger with DX Coil Unit. For installation of outdoor units, follow the Installation Manual supplied with the outdoor unit. Moreover, as this installation manual includes the important articles concerning the "Machinery" Directive (Directive 2006/42/EC), please read through the manual and make sure you understand it. After installation, give this Installation Manual, the Owner's Manual and the Installation Manual supplied with the outdoor unit to the customer and tell the customer to keep them safe.

Prepare an exclusive power source for indoor units, independent to that for outdoor units. Y-shaped branching joints or a branching header (separately purchased) are required for connecting pipes between indoor and outdoor units. Choose either of them considering the system capacity concerning piping. For installing branching pipes, refer to the installation manual of the Y-shaped branching unit or branching header (separately purchased). Outdoor connecting branching joints are required for connecting between outdoor units.

**Generic Denomination: Air conditioner (Air to Air Heat Exchanger with DX Coil Unit)**

**Definition of Qualified Installer or Qualified Service Person**

The Air to Air Heat Exchanger with DX Coil Unit must be installed, maintained, repaired and removed by a qualified installer or qualified service person. When any of these jobs is to be done, ask a qualified installer or qualified service person to do them for you.

A qualified installer or qualified service person is an agent who has the qualifications and knowledge described in the table below.





Agent	Qualifications and knowledge which the agent must have
Qualified installer	<ul style="list-style-type: none"> <li>• The qualified installer is a person who installs, maintains, relocates and removes the Air to Air Heat Exchanger with DX Coil Units made by Toshiba Carrier Corporation. He or she has been trained to install, maintain, relocate and remove the Air to Air Heat Exchanger with DX Coil Units made by Toshiba Carrier Corporation or, alternatively, he or she has been instructed in such operations by an individual or individuals who have been trained and is thus thoroughly acquainted with the knowledge related to these operations.</li> <li>• The qualified installer who is allowed to do the electrical work involved in installation, relocation and removal has the qualifications pertaining to this electrical work as stipulated by the local laws and regulations, and he or she is a person who has been trained in matters relating to electrical work on the Air to Air Heat Exchanger with DX Coil Units made by Toshiba Carrier Corporation or, alternatively, he or she has been instructed in such matters by an individual or individuals who have been trained and is thus thoroughly acquainted with the knowledge related to this work.</li> <li>• The qualified installer who is allowed to do the refrigerant handling and piping work involved in installation, relocation and removal has the qualifications pertaining to this refrigerant handling and piping work as stipulated by the local laws and regulations, and he or she is a person who has been trained in matters relating to refrigerant handling and piping work on the Air to Air Heat Exchanger with DX Coil Units made by Toshiba Carrier Corporation or, alternatively, he or she has been instructed in such matters by an individual or individuals who have been trained and is thus thoroughly acquainted with the knowledge related to this work.</li> <li>• The qualified installer who is allowed to work at heights has been trained in matters relating to working at heights with the Air to Air Heat Exchanger with DX Coil Units made by Toshiba Carrier Corporation or, alternatively, he or she has been instructed in such matters by an individual or individuals who have been trained and is thus thoroughly acquainted with the knowledge related to this work.</li> </ul>
Qualified service person	<ul style="list-style-type: none"> <li>• The qualified service person is a person who installs, repairs, maintains, relocates and removes the Air to Air Heat Exchanger with DX Coil Units made by Toshiba Carrier Corporation. He or she has been trained to install, repair, maintain, relocate and remove the Air to Air Heat Exchanger with DX Coil Units made by Toshiba Carrier Corporation or, alternatively, he or she has been instructed in such operations by an individual or individuals who have been trained and is thus thoroughly acquainted with the knowledge related to these operations.</li> <li>• The qualified service person who is allowed to do the electrical work involved in installation, repair, relocation and removal has the qualifications pertaining to this electrical work as stipulated by the local laws and regulations, and he or she is a person who has been trained in matters relating to electrical work on the Air to Air Heat Exchanger with DX Coil Units made by Toshiba Carrier Corporation or, alternatively, he or she has been instructed in such matters by an individual or individuals who have been trained and is thus thoroughly acquainted with the knowledge related to this work.</li> <li>• The qualified service person who is allowed to do the refrigerant handling and piping work involved in installation, repair, relocation and removal has the qualifications pertaining to this refrigerant handling and piping work as stipulated by the local laws and regulations, and he or she is a person who has been trained in matters relating to refrigerant handling and piping work on the Air to Air Heat Exchanger with DX Coil Units made by Toshiba Carrier Corporation or, alternatively, he or she has been instructed in such matters by an individual or individuals who have been trained and is thus thoroughly acquainted with the knowledge related to this work.</li> <li>• The qualified service person who is allowed to work at heights has been trained in matters relating to working at heights with the Air to Air Heat Exchanger with DX Coil Units made by Toshiba Carrier Corporation or, alternatively, he or she has been instructed in such matters by an individual or individuals who have been trained and is thus thoroughly acquainted with the knowledge related to this work.</li> </ul>

**Definition of Protective Gear**

When the Air to Air Heat Exchanger with DX Coil Unit is to be transported, installed, maintained, repaired or removed, wear protective gloves and 'safety' work clothing. In addition to such normal protective gear, wear the protective gear described below when undertaking the special work detailed in the table below. Failure to wear the proper protective gear is dangerous because you will be more susceptible to injury, burns, electric shocks and other injuries.

Work undertaken	Protective gear worn
All types of work	Protective gloves 'Safety' working clothing
Electrical-related work	Gloves to provide protection for electricians and from heat
Work done at heights (50 cm or more)	Helmets for use in industry
Transportation of heavy objects	Shoes with additional protective toe cap
Repair of outdoor unit	Gloves to provide protection for electricians and from heat

## ■ Warning indications on the air conditioner unit

Warning indication	Description		
 <table border="1"> <tr> <td><b>WARNING</b></td> </tr> <tr> <td><b>ELECTRICAL SHOCK HAZARD</b> Disconnect all remote electric power supplies before servicing.</td> </tr> </table>	<b>WARNING</b>	<b>ELECTRICAL SHOCK HAZARD</b> Disconnect all remote electric power supplies before servicing.	<b>WARNING</b>  <b>ELECTRICAL SHOCK HAZARD</b> Disconnect all remote electric power supplies before servicing.
<b>WARNING</b>			
<b>ELECTRICAL SHOCK HAZARD</b> Disconnect all remote electric power supplies before servicing.			
 <table border="1"> <tr> <td><b>WARNING</b></td> </tr> <tr> <td>Moving parts. Do not operate unit with inspection cover removed. Stop the unit before the servicing.</td> </tr> </table>	<b>WARNING</b>	Moving parts. Do not operate unit with inspection cover removed. Stop the unit before the servicing.	<b>WARNING</b>  Moving parts. Do not operate unit with inspection cover removed. Stop the unit before the servicing.
<b>WARNING</b>			
Moving parts. Do not operate unit with inspection cover removed. Stop the unit before the servicing.			
 <table border="1"> <tr> <td><b>CAUTION</b></td> </tr> <tr> <td>High temperature parts. You might get burned when removing this cover.</td> </tr> </table>	<b>CAUTION</b>	High temperature parts. You might get burned when removing this cover.	<b>CAUTION</b>  High temperature parts. You might get burned when removing this cover.
<b>CAUTION</b>			
High temperature parts. You might get burned when removing this cover.			
 <table border="1"> <tr> <td><b>CAUTION</b></td> </tr> <tr> <td>Do not touch the aluminum fins of the unit. Doing so may result in injury.</td> </tr> </table>	<b>CAUTION</b>	Do not touch the aluminum fins of the unit. Doing so may result in injury.	<b>CAUTION</b>  Do not touch the aluminium fins of the unit. Doing so may result in injury.
<b>CAUTION</b>			
Do not touch the aluminum fins of the unit. Doing so may result in injury.			

# 1 Precautions for Safety

## ⚠ WARNING

### General

- Before starting to install the Air to Air Heat Exchanger with DX Coil Unit, read carefully through the Installation Manual, and follow its instructions to install the Air to Air Heat Exchanger with DX Coil Unit.
- Install the Air to Air Heat Exchanger with DX Coil Unit at least 2.5 m above the floor level since otherwise the users may injure themselves or receive electric shocks if they poke their fingers or other objects into the Air to Air Heat Exchanger with DX Coil Unit while it is running.
- Before opening the electrical control cover, inspection cover or maintenance cover of the Air to Air Heat Exchanger with DX Coil Unit, set the circuit breaker to the OFF position. Failure to set the circuit breaker to the OFF position may result in electric shocks through contact with the interior parts.
- Only a qualified installer (\*1) or qualified service person (\*1) is allowed to undertake work at heights using a stand of 50 cm or more or to remove the electrical control cover, inspection cover or maintenance cover of the Air to Air Heat Exchanger with DX Coil Unit to undertake work.
- When working at heights, use a ladder which complies with the ISO 14122 standard, and follow the procedure in the ladder's instructions. Also wear a helmet for use in industry as protective gear to undertake the work.
- Only a qualified installer (\*1) or qualified service person (\*1) is allowed to carry out the electrical work of Air to Air Heat Exchanger with DX Coil Unit.
- Under no circumstances must this work be done by an unqualified individual since failure to carry out the work properly may result in electric shocks and / or electrical laws.
- Electrical wiring work shall be conducted according to law and regulation in the community and Installation manual. Failure to do so may result in electrocution / short circuit.
- When repairing the electrical parts or undertaking other electrical jobs, wear gloves to provide protection for electricians and from heat. Failure to wear this protective gear may result in burn.
- Before carrying out the installation, maintenance, repair or removal work be sure to set the circuit breaker for the Air to Air Heat Exchanger Unit to the OFF position. Otherwise, electric shocks may result.
- Place a "Work in progress" sign near the circuit breaker while the installation, maintenance, repair or removal work is being carried out. There is a danger of electric shocks if the circuit breaker is set to ON by mistake.
- When cleaning the filter, heat exchange element or humidifier of the Air to Air Heat Exchanger with DX Coil Unit, set the circuit breaker to OFF without fail, and place a "Work in progress" sign near the circuit breaker before proceeding with the work.
- Before opening the electrical control cover, inspection cover and maintenance cover of the Air to Air Heat Exchanger with DX Coil Unit, set the circuit breaker to the OFF position.
- Failure to set the circuit breaker to the OFF position may result in electric shocks through contact with the interior parts. Only a qualified installer (\*1) or qualified service person (\*1) is allowed to remove the electrical control cover, inspection cover and maintenance cover of the Air to Air Heat Exchanger with DX Coil Unit and do the work required.
- Only a qualified installer (\*1) or qualified service person (\*1) is allowed to undertake work at heights using a stand of 50 cm or more or to remove the electrical control box cover, inspection cover or maintenance cover of the Air to Air Heat Exchanger with DX Coil Unit to undertake work.
- When working at heights, use a ladder which complies with the ISO 14122 standard, and follow the procedure in the ladder's instructions. Also wear a helmet for use in industry as protective gear to undertake the work.
- When cleaning the filter, heat exchange element or humidifier of the Air to Air Heat Exchanger with DX Coil Unit, set the circuit breaker to OFF without fail, and place a "Work in progress" sign near the circuit breaker before proceeding with the work.
- Do not install the Air to Air Heat Exchanger with DX Coil Unit in a location that may be subject to a risk of expire to a combustible gas. If a combustible gas leaks and becomes concentrated around the unit, a fire may occur.
- Do not place any combustion appliance in a place where it is directly exposed to the wind of Air to Air Heat Exchange with DX Coil unit, otherwise it may cause imperfect combustion.
- If refrigerant gas has leaked during the installation work, ventilate the room immediately. If the leaked refrigerant gas comes in contact with fire, noxious gas may be generated.
- After the installation or servicing work, check the refrigerant gas does not leak.
- If refrigerant gas leaks in the room, poisonous gas generates when gas touches to fire such as fan heater, stove or cooking stove though the refrigerant gas itself is innocuous.
- Inspect the Air to Air Heat Exchanger with DX Coil Unit for any falling hazard of the unit before maintenance or repair.
- Do not modify the products. Do not also disassemble or modify the parts. It may cause a fire, electric or injury.

### Selection of installation location

- Install the Air to Air Heat Exchanger with DX Coil Unit securely in a location where the base can sustain the weight adequately. If the strength is insufficient, the unit may fall down resulting in human injury.
- Do not install the unit in places 1) with high temperature 2) where the unit is subject to direct fire 3) where much oil smoke is generated. Otherwise, a fire may result.

- Do not install the unit in a machinery factory or a chemical plant, where a toxic gas containing acid, alkali, an organic solvent, or paint, or a gas containing a corrosive substance is generated. Gas poisoning or a fire may result.
- Do not install in a location where flammable gas may leak or accumulate around the unit, it may ignite and cause a fire.
- Install the unit so that the air discharge is located at least 1.5 m from the nearest fire alarm. Otherwise, when a fire occurs, the fire alarm may be late to detect it, or may not detect it at all.

#### Installation

- Transport it by the truck or the forklift. Transport it by six people or more when the person transports it temporarily. The waist etc. might be hurt when not following it.
- When transporting the Air to Air Heat Exchanger with DX Coil Unit, wear shoes with additional protective toe caps, protective gloves, and other protective clothing.
- When transporting the Air to Air Heat Exchanger with DX Coil Unit, do not take hold of the bands around the packing carton. You may injure yourself if the bands should break.
- When the Air to Air Heat Exchanger with DX Coil Unit is to be suspended, the designated hanging bolts (M12) and nuts (M12) must be used
- Install the Air to Air Heat Exchanger with DX Coil Unit at enough strong place to withstand the weight of the unit. If the strength is not enough, the unit may fall down resulting in injury
- Follow the instructions in the Installation Manual to install the Air to Air Heat Exchanger with DX Coil Unit. Failure to follow these instructions may cause the product to fall down or topple over or give rise to noise, vibration, water leakage, etc.
- Wear protective gloves and safety work clothing during installation, servicing and removal.
- Do not touch the aluminum fin of the Air to Air Heat Exchanger with DX Coil Unit or outdoor unit. You may injure yourself if you do so. If the fin must be touched for some reason, first put on protective gloves and safety work clothing, and then proceed.
- Tighten the flare nut with a torque wrench in the specified manner. Excessive tighten of the flare nut may cause a crack in the flare nut after a long period, which may result in refrigerant leakage.
- When working at heights, put a sign in place so that no-one will approach the work location, before proceeding with the work. Parts and other objects may fall from above, possibly injuring a person below.
- Before starting to install the Air to Air Heat Exchanger with DX Coil Unit, read carefully through the Installation Manual, and follow its instructions to install the Air to Air Heat Exchanger with DX Coil Unit.
- Only a qualified installer (\*1) or qualified service person (\*1) is allowed to install the Air to Air Heat Exchanger with DX Coil Unit. If the Air to Air Heat Exchanger with DX Coil Unit is installed by an unqualified individual, a fire, electric shocks, injury, water leakage, noise and / or vibration may result.
- Upon completion of the installation work, check for the insulation resistance. Then conduct a test run to check that the Air to Air Heat Exchanger with DX Coil Unit is operating properly.
- After the work has finished, be sure to use an insulation tester set (500 V Megger) to check the resistance is 1 MΩ or more between the charge section and the non-charge metal section (Earth section). If the resistance value is low, a disaster such as a leak or electric shock is caused at user's side.
- Before starting to install the Air to Air Heat Exchanger with DX Coil Unit, read carefully through the Installation Manual, and follow its instructions to install the Air to Air Heat Exchanger with DX Coil Unit.
- Follow the instructions in the Installation Manual to install the Air to Air Heat Exchanger with DX Coil Unit. Failure to follow these instructions may cause the product to fall down or topple over or give rise to noise, vibration, water leakage, etc.
- Before operating the Air to Air Heat Exchanger with DX Coil Unit after having completed the work, check that the electrical control cover, inspection cover and maintenance cover are closed, and set the circuit breaker to the ON position. You may receive an electric shock if the power is turned on without first conducting these checks.
- Install the unit in the prescribed manner for protection against strong wind and earthquake. Incorrect installation may result in the unit falling down, or other accidents.
- Attach an anti bird net or the like to the outside air intake. Remove any foreign object such as a nest; otherwise, an oxygen shortage may occur in the room.
- Leave ample space between the outside air intake and the outlet for combustion gas. Otherwise, an oxygen shortage may occur in the room.
- When metallic ducts pass through a wooden construction covered with a metal lath, wire lath, or metal plate, install the ducts so that they are not electrically in contact with the metal parts of wooden construction. If a short circuit occurs, a fire may result.
- Use the supplied or specified parts for installation. Otherwise, the unit falling down, water leakage, an electric shock, or a fire may result.
- Perform anti-freezing work if the installation place is subject to freezing. Otherwise, the solenoid valve or pipes are damaged and water leakage may result.
- Do not install the unit in a place where the outside temperature (especially around the unit or the air grill) falls below 0 °C. Otherwise, water in the pipes, in the humidifying element, or in the solenoid valve freezes and a breakdown or water leakage may result.
- If the ducts pass through a fire protection zone, use a noncombustible duct and install a fire damper. The flame may spread when a fire occurs.

- Install the ducts to the outside inclined downward so that rainwater does not enter the ducts. Otherwise, water will enter the room and household goods will become wet.
- Insulate the ducts from heat using a heat insulator to prevent condensation. Otherwise, furniture may be damaged.
- If it is hot and humid in the ceiling cavity, install a ventilator. Otherwise, a fire or a short circuit may result.
- Install drain pipes to drain water securely referring to the Installation Manual. In addition, insulate the pipes from heat to prevent condensation. Inappropriate piping results in water leaking into the room and the ceiling, floor or furniture may be damaged.

#### Explanations given to user

- After the installation work, Follow the Owner's manual to explain to the customer how to use and maintain the unit.
- Do not place any combustion appliance in a place where it is directly exposed to the wind of Air to Air Heat Exchanger with DX Coil Unit, otherwise it may cause imperfect combustion.
- For safety, turn off the unit if you do not use it for a long time. A fire or an electric shock may result due to insulation degradation.

#### Relocation

- Only a qualified installer (\*1) or qualified service person (\*1) is allowed to relocate the Air to Air Heat Exchanger with DX Coil Unit. It is dangerous for the Air to Air Heat Exchanger with DX Coil Unit to be relocated by an unqualified individual since a fire, electric shocks, injury, water leakage, noise and / or vibration may result.
- For the refrigerant recovery work (collection of refrigerant from the pipe to the compressor), stop the compressor before disconnecting the refrigerant pipe. If the refrigerant pipe is disconnected while the compressor is working with the valve open, the compressor sucks air and the refrigeration cycle is overpressurized, which may cause a burst or injury.

#### Refrigerant piping

- Install the refrigerant pipe securely during the installation work before operating the compressor. If the compressor is operated with the valve open and without refrigerant pipe, the compressor sucks air and the refrigeration cycles is over pressurized, which may cause a injury.
- Do not use any refrigerant different from the one specified for complement or replacement. Otherwise, abnormally high pressure may be generated in the refrigeration cycle, which may result in a failure or explosion of the product or an injury to your body.
- Only a qualified installer (\*1) or qualified service person (\*1) is allowed to do installation work. If installation is carried out by an unqualified individual, a fire, electric shocks, injury, water leakage, noise and / or vibration may result.

#### Electrical wiring

- Use wiring that meets the specifications in the Installation Manual and the stipulations in the local regulations and laws. Use of wiring which does not meet the specifications may give rise to electric shocks, electrical leakage, smoking and / or a fire.
- Be sure to connect earth wire. (Grounding work)
- Incomplete earthing cause an electric shock.
- Do not connect earth wires to gas pipes, water pipes, lightning rods or earth wires for telephone wires
- After completing the repair or relocation work, check that the earth wires are connected properly.
- Install a circuit breaker that meets the specifications in the installation manual and the stipulations in the local regulations and laws.
- Install the circuit breaker where it can be easily accessed by the agent.
- When installing the circuit breaker outdoors, install one which is designed to be used outdoors.
- When you have noticed that some kind of trouble (such as when an error display has appeared, there is a smell of burning, abnormal sounds are heard, the Air to Air Heat Exchanger with DX Coil Unit falls to cool or heat, or water is leaking) has occurred in the Air to Air Heat Exchanger with DX Coil Unit, do not touch the Air to Air Heat Exchanger with DX Coil Unit yourself but set the circuit breaker to the OFF position, and contact a qualified service person (\*1). Take steps to ensure that the power will not be turned on (by marking "out of service" near the circuit breaker, for instance) until qualified service person arrives. Continuing to use the Air to Air Heat Exchanger with DX Coil Unit in the trouble status may cause mechanical problems to escalate or result in electric shocks, etc.
- Upon completion of the installation work, tell the user where the circuit breaker is located. If the user does not know where the circuit breaker is, he or she will not be able to turn it off in the event that trouble has occurred in the Air to Air Heat Exchanger with DX Coil Unit.
- Use the rated voltage. Otherwise, a fire or an electric shock may result.
- Connect power cords or connection wires securely so that the power supply cover is attached properly. Otherwise, a fire or an electric shock may result.
- Do not install the unit or the switch in a humid place such as a bathroom. Otherwise, a fire or an electric shock may result.

(\*1) Refer to the "Definition of Qualified Installer or Qualified Service Person."

**⚠ CAUTION****New Refrigerant Air to Air Heat Exchanger with DX Coil Unit Installation**







- THIS Air to Air Heat Exchanger with DX Coil Unit ADOPTS THE NEW HFC REFRIGERANT (R410A) WHICH DOES NOT DESTROY OZONE LAYER.
- The characteristics of R410A refrigerant are; easy to absorb water, oxidizing membrane or oil, and its pressure is approx. 1.6 times higher than that of refrigerant R22. Accompanied with the new refrigerant, refrigerating oil has also been changed. Therefore, during installation work, be sure that water, dust, former refrigerant, or refrigerating oil does not enter the refrigerating cycle.
- To prevent charging an incorrect refrigerant and refrigerating oil, the sizes of connecting sections of charging port of the main unit and installation tools are changed from those for the conventional refrigerant.
- Accordingly the exclusive tools are required for the new refrigerant (R410A).
- For connecting pipes, use new and clean piping designed for R410A, and please care so that water or dust does not enter.

**To Disconnect the Appliance from Main Power Supply.**

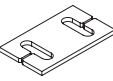
- Means for disconnection having a contact separation in all poles at least 3 mm must be incorporated in the fixed wiring in accordance with the wiring rules.

**The installation fuse (All Types Can Be Used) must be used for the power supply line of this Air to Air Heat Exchanger with DX Coil Unit.**

## 2 Accessory Parts

Name	Quantity	Shape	Usage
Installation manual	1	This manual	(Be sure to hand it to the customers.)
CD-ROM (Owner's manual, Installation manual)	1	—	(For other languages that do not appear in this manual, please refer to the enclosed CD-ROM.)
Owner's manual	1	—	(Be sure to hand it to the customers.)
Insulation (VNK type only)	1		For strainers
Insulation	4		For insulation of hanging brackets
Insulation (VNK type only)	1		For water supply pipes
Duct connectors	4		Connector with ducts
Screws	24		For duct connectors
Banding band	4		For anchoring the insulated pipes
Heat insulator	2		For heat insulation of pipe connecting section

### ■ Separately sold parts

The remote controller (NRC-01HE) is sold separately. For the installation of these products, follow the installation manual supplied with it.

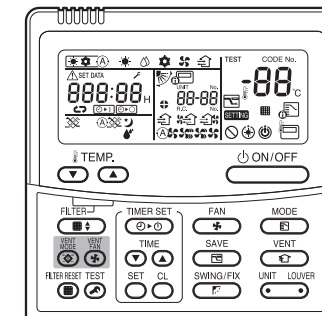

## 3 Restrictions on System Construction

### ■ System combinations available

The Air to Air Heat Exchanger with DX Coil Unit can be connected to a Super Module Multi system -i.

### ■ Range of combination

- The Air to Air Heat Exchanger with DX Coil Unit can be connected with either one of the following multi systems:
  - System with Air to Air Heat Exchanger with DX Coil Unit and air conditioner indoor units
  - Air to Air Heat Exchanger with DX Coil Unit system
- The overall capacity (HP) of air conditioner indoor units and Air to Air Heat Exchanger with DX Coil Unit should be 80 to 135 % of that of outdoor units.
- When calculating the connection capacity of the indoor unit, use the following horse power:

Model name	MMD-	VNK502HEXE VN502HEXE	VNK802HEXE VN802HEXE	VNK1002HEXE(2) VN1002HEXE(2)
HP		1.0	1.7	2.0

#### System with Air to Air Heat Exchanger with DX Coil Unit and air conditioner indoor units

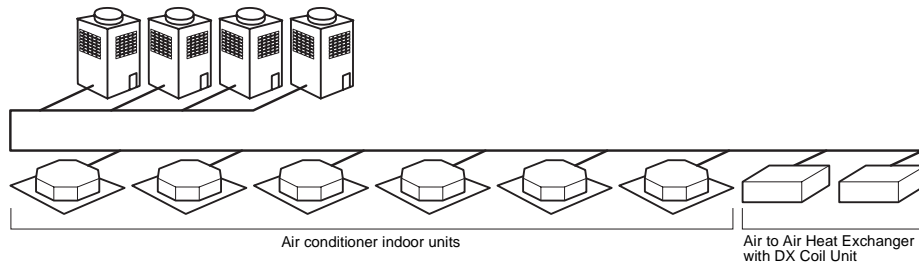

#### Air to Air Heat Exchanger with DX Coil Unit system

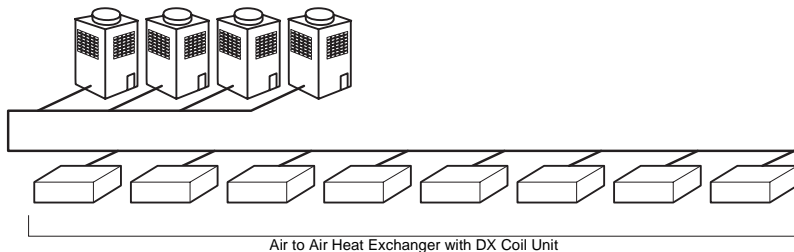

The Air to Air Heat Exchanger with DX Coil Unit and the concealed duct type fresh air intake unit cannot be used together in the same system.

## 4 Selection of Installation Place

### ⚠ CAUTION

- Do not install the Air to Air Heat Exchanger with DX Coil Unit in a location subject to a risk of exposure to a combustible gas. If a combustible gas leaks and stays around the unit, a fire may occur.
- Install the unit so that the air discharge is located at least 1.5 m from the nearest fire alarm. Otherwise, when a fire occurs, the fire alarm may be late to detect it, or may not detect it at all.

Install the indoor unit in a place where cool / warm air circulates evenly.

#### Avoid installing in the following places.

- Places where the outside temperature falls below 5 °C. (If the temperature around the unit falls below 5 °C, water in humidifier freezes and the water will leak. (VNK type only))
- Places where air pipes are installed in the ceiling cavity.
- Place exposed to air with high salt content (seaside area)
- Place exposed to large quantities of sulfide gas (hot spring). (Should the unit be used in these places, special protective measures are needed.)
- A restaurant kitchen where a lot of oil is used or place near machines in a factory (Oil adhering to the heat exchanger and resin part (turbo fan) in the indoor unit may reduce the performance, generate mist or dew drop, or deform or damage resin parts.)
- Places where obstacles disturbing the air current such as a ventilation hole or lighting apparatus are near the unit. (The performance of the unit may be deteriorated or the unit may not work due to disturbance of the air current.)
- Do not use the air conditioner for special purposes such as preserving food, precision instruments, or art objects, or where breeding animals or growing plants are kept. (This may degrade the quality of preserved materials.)
- Place where any of high-frequency appliances (including inverter devices, private power generators, medical equipment, and communication equipment) and inverter-type fluorescent light is installed. (A malfunction of the air conditioner, abnormal control, or problems due to noise to such appliances / equipment may occur.)
- Places where there is something that must not become wet. When the humidity reaches 80 % or

- more, or when the draining pipe is clogged, water droplets may fall from the unit.
- Place near a door or window exposed to humid outside air (Dew dropping may form.).
- Place where special spray is used frequently.
- Places such as outdoors or under the eaves (where rain may fall directly on the unit).
- Do not use the unit in chemical plants with a cooling system which uses liquid carbon dioxide, etc.

### ■ Installation space

Leave ample space for installation or servicing.

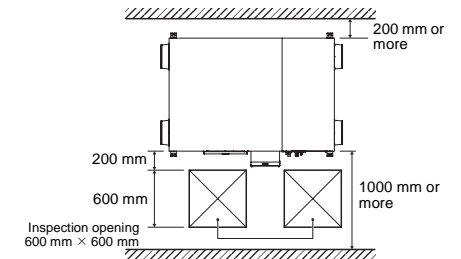

#### REQUIREMENT

- Before installing indoor units, attach any accessories (drain-up kit, etc.: separately purchased) to them. In addition, make inspection opening on both sides of each unit.
- The size of inspection opening should be 600 mm x 600 mm.

## ■ Installation in high-humidity places

- **Do not use the unit in a kitchen or bathroom.**

If the unit is used in a place where much oil smoke is generated or a place with high humidity, the filter or the heat exchanging element will become clogged and the unit will not work.

- **Be careful of dewing and frosting.**

- In cold regions, the surface of the unit or the duct connector may be affected by condensation or frosting depending on the outdoor air conditions or temperature / humidity of the ceiling cavity even though the conditions for use are observed. In this case, add a heat insulator.

- Water droplets may fall if the unit is operated in wet conditions.

In particular, high humidity may occur even during non-rainy season if the unit is installed in the following locations:

1. Ceiling of a tile roof
2. Ceiling of a slate roof

In this case, attach thermal insulators (glass wool, etc.) on the unit's surface.

Take care so that you can remove the side board (service panel) easily even when insulators are attached.

Also insulate the duct and its connectors sufficiently.

- Do not install the unit in a place where there is something that must not become wet. Depending on the temperature or humidity of outdoor air and the installation place, water droplets may fall from the unit.
- As shown in the figure to the below, suppose a high temp absorbing air condition A and a low temp absorbing air condition B are plotted on the air line figure, then a high temp air A is heat-exchanged by the unit and goes out of the saturation curve as shown by Point C. In this case, the unit will be dewed or frosted. To avoid this, heating a low temp air B up to B' is required so as to get C' below the saturation curve, before using the unit.

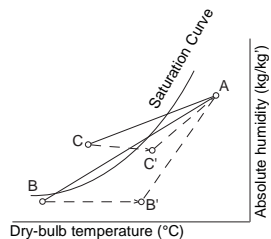

- **Do not install the unit near a water heater.**

# 5 Installation of Indoor Unit

## ⚠ WARNING

- **Install the air conditioner at enough strong place to withstand the weight of the unit.**  
If the strength is not enough, the unit may fall down resulting in injury.
- **To provide against strong wind or an earthquake, install the unit appropriately.**  
Inappropriate installation may result in the unit falling down and causing an accident.

## NOTE

### Strictly comply with the following rules to prevent damage of the indoor units and human injury.

- Do not put a heavy article on the indoor unit. (Even units are packaged)
- Carry in the indoor unit as it is packaged if possible. If carrying in the indoor unit unpacked by necessity, be sure to use buffering cloth, etc. to not damage the unit.
- To move the indoor unit, hold the hooking metals (4 positions) only.  
Do not apply force to the other parts (refrigerant pipe, drain pan, foamed parts, or resin parts, etc.).  
Before you handle hanging brackets, put on thick gloves for protection.
- Supplied accessories are placed near the electrical control box. Do not dispose of the accessories with the packaging. (See the figure on the right.)
- When a vibration-proof hanging bracket is attached to a hanging bolt, confirm that the unit does not vibrate more through using the vibration-proof hanging bracket.

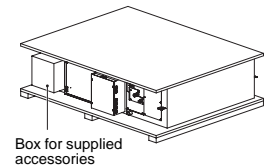

- Use a forklift to carry the unit. As it is packed in a cardboard box, do not drag or push it.
- Suction duct length must be longer than 850 mm.
- Helmet must be worn to protect your head from falling objects.  
Especially, when you work under an inspection opening, helmet must be worn to protect your head from falling objects from the opening.

## ■ External dimensions

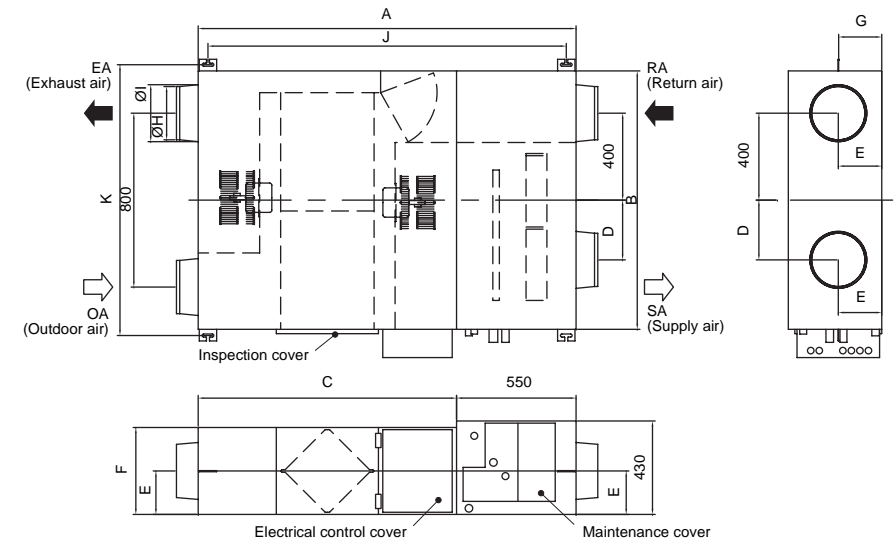

Unit: mm

Model No.	A	B	C	D	E	F
MMD-VNK502HEXE, VN502HEXE	1,690	1140	1140	250	175	350
MMD-VNK802HEXE, VN802HEXE	1,739	1189	1189	275	200	400
MMD-VNK1002HEXE, VN1002HEXE	1,739	1189	1189	275	200	400
MMD-VNK1002HEXE2, VN1002HEXE2	1,739	1189	1189	275	200	400

Model No.	G	H	I	J	K	Duct diameter	Diameter of refrigerant piping at the gas side (L)	Diameter of refrigerant piping at the liquid side (M)
MMD-VNK502HEXE, VN502HEXE	175	Ø195	Ø212	1601	1197	Ø200	Ø9.5	Ø6.4
MMD-VNK802HEXE, VN802HEXE	200	Ø245	Ø262	1650	1246	Ø250	Ø12.7	Ø6.4
MMD-VNK1002HEXE, VN1002HEXE	200	Ø245	Ø262	1650	1246	Ø250	Ø12.7	Ø6.4
MMD-VNK1002HEXE2, VN1002HEXE2	200	Ø245	Ø262	1650	1246	Ø250	Ø12.7	Ø6.4

Center of gravity

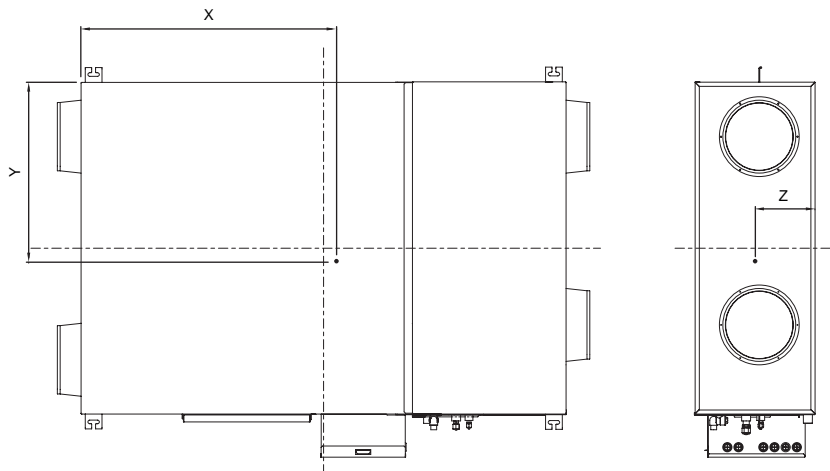

Model No.	X	Y	Z	Weight
MMD-VNK502HEXE	902	643	174	91
MMD-VNK802HEXE	901	667	199	111
MMD-VNK1002HEXE	900	667	199	112
MMD-VNK1002HEXE2	894	666	199	114
MMD-VN502HEXE	870	642	174	84
MMD-VN802HEXE	856	663	198	100
MMD-VN1002HEXE	853	663	198	101
MMD-VN1002HEXE2	858	662	198	103

■ Installing the indoor unit

Attaching the duct connector

Attach 4 duct connectors to the unit using the six screws supplied for each connector.

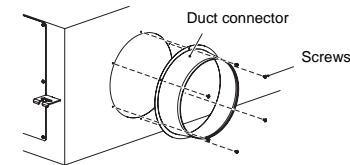

Attaching the washers and nuts

- 1 Procure the hanging bolts, nuts, and washers locally.
- 2 Attach the washers and nuts to the hanging bolt (M12) as shown in the figure on the right.

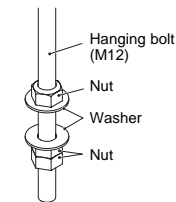

Fixing the unit

- 1 Fit the hanging bracket on the hanging bolt, then adjust the position of the unit so that it is level.
- 2 Tighten the bolts securely using a double nut to prevent the bolts from becoming loose.
  - If the bolts are not tightened securely, the unit will vibrate and an accident may occur.
  - Tighten the bolts so that they can bear the weight of the unit.
- 3 Confirm that the unit is installed level.
  - Confirm that the unit is installed level or is inclined within 1 °(downward) against the drain outlet using a spirit level.
  - Do not set the unit inclined (upward) against the drain outlet; otherwise, water will leak from the unit.

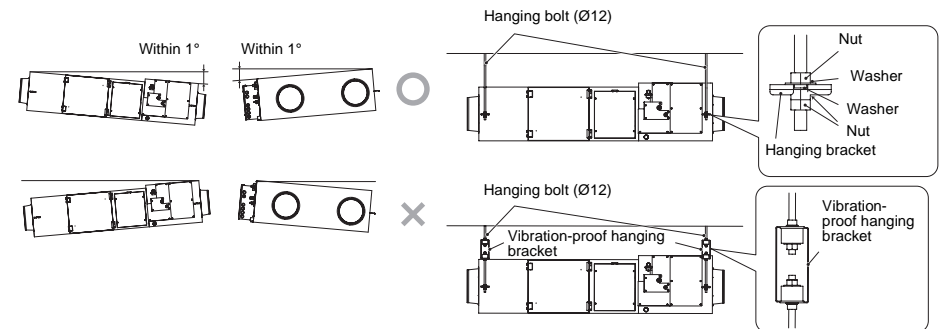

⚠ CAUTION

To preventing vibration, use vibration proof hanging brackets (procured locally).



## 6 Drain Piping Work

### CAUTION

Install drain pipes to drain water securely referring to the Installation Manual. In addition, insulate the pipes from heat to prevent condensation. (Inappropriate piping results in water leaking into the room and furniture may be damaged.)

### REQUIREMENT

- Install drain pipes to prevent water from leaking.
- Set the drain pipe with downward slope (1/100 or more), and do not make swelling or trap on the piping. It may cause an abnormal sound.
- For length of the traversing drain pipe, restrict to 20 m or less.  
In case of a long pipe, provide support brackets with interval of 1.5 - 2 m in order to prevent waving.
- Set the collective piping as shown in the below figure.
- Do not apply force to the connecting part of the drain pipe.
- Perform heat insulation of the drain pipes of the indoor unit.
- Perform heat insulation of the connecting part with the indoor unit.  
An incomplete heat insulation causes dew dropping.
- If the installation place is subject to freezing, perform anti-freezing work.

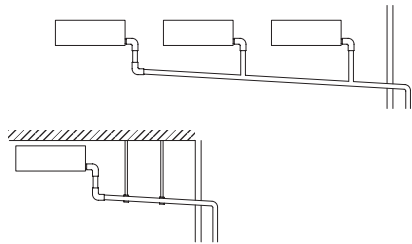

### Piping / heat insulating material

Procure the following materials for piping and heat insulating locally.

Piping	Hard vinyl chloride pipe VP25 (Outer dia. : Ø32 mm)
	Elbow for VP25
Heat insulator	Foam polyethylene: Thickness 10 mm or more

### Connecting drain pipe

- Connect the elbow for vinyl chloride pipe VP25 downward to the drain outlet.
- Position the tip of the drain pipe so that water can be drained, and open the other end.

### NOTE

- Connect hard vinyl chloride pipes securely using an adhesive for vinyl chloride to avoid water leakage.
- It takes some time until the adhesive is dried and hardened (refer to the manual of the adhesive). Do not apply stress to the joint with the drain pipe during this time period.

### Drain-up

For the installation instruction of a drain-pump kit (sold separately), refer to the Installation Manual supplied with the drain-pump kit.

### Check the draining

In the test run, check that water drain is properly performed and water does not leak from the connecting part of the pipes.

### REQUIREMENT

- Check draining also when installed in heating period.
- Using a pitcher or hose, pour water (1500 - 2000 cc) into the discharge port before installation of the maintenance cover.

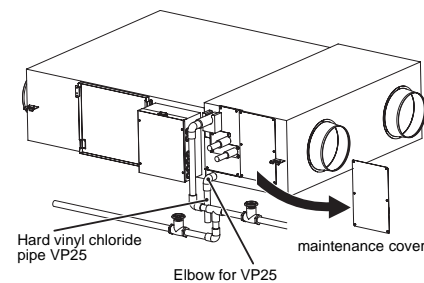

## 7 Water Supply Piping for a Humidifier (VNK type only)

### CAUTION

Install the water supply pipes after washing the inside of them with water.

Install a drain valve on the water supply pipe, then drain the water until the drained water runs clear. Do not to allow cutting fluid or detergent to enter the pipes.

The water quality of the humidifiers supply water should meet public waterworks standards, and have a hardness less than 100 mg/l. If the supply water does not meet these standards, use a deionizer.

### NOTE

- If the installation place is subject to freezing, perform anti-freezing work.
- Do not connect the water supply pipe directly to the public water pipe. Use a cistern tank (procured locally).
- Use water which meets the following conditions:
  - Water pressure:  $2 \times 10^4$  Pa to  $49 \times 10^4$  Pa
  - Water temperature: 5 °C to 40 °C
- Attach a service valve or drain valve (procured locally) near the water intake.  
While the humidifier is not in operation, the water inside the pipes and cistern tank does not flow and becomes stagnant.  
If the stagnant water is used for water supply in the initial stages of using the humidifier (heater), a smell may come out or bacteria may multiply.  
If you do not use the humidifier for a long time, drain off water from the pipes and from the cistern tank.  
Before the season for using the humidifier (heater) arrives, open the drain / water supply valves to exchange the water inside the pipes.
- Close the water supply valve when the season for using the humidifier (heater) has passed.
- Prevent corrosive gas, salt, or oil mist from entering the air.
- Clean the strainer for water supply when the season for using the humidifier (heater) arrives.
- Fix the water supply pipes so that excessive force is not applied to them.
- Arrange the pipes so that they do not obstruct opening the maintenance cover for the heat transfer element / humidification element or removing the humidification element.
- Do not allow cutting fluid from being mixed with the supplying water as it causes the humidifying unit or drain pan to deteriorate. If cutting fluid sticks to it, wash it immediately in a sufficient amount of water.
- Use 2 wrenches, to connect a pipe to a single union pipe joint or to remove it from the single union pipe joint.
- Drain off water from the cistern tank when the humidifier is not used.

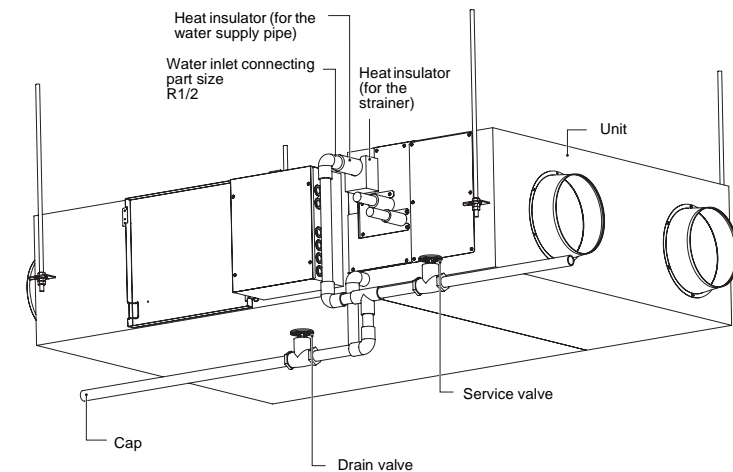

## 8 Installation of Ducts

### CAUTION

#### Insulate the ducts to prevent condensation.

Inappropriate installation results in water leaking into the room and furniture may be damaged.  
Suction duct length must be longer than 850 mm.

### ■ Installing ducts

- 1 Insert the duct into the duct connector, then fix the duct using aluminum tape to prevent air from leaking.
- 2 Hang the duct from the ceiling so that excessive force is not applied to the unit.
- 3 Leave sufficient space between the room air discharge and the room air intake.
- 4 Install 2 ducts to the outside inclined downward between 1/100 and 1/50 so that water does not enter the ducts.

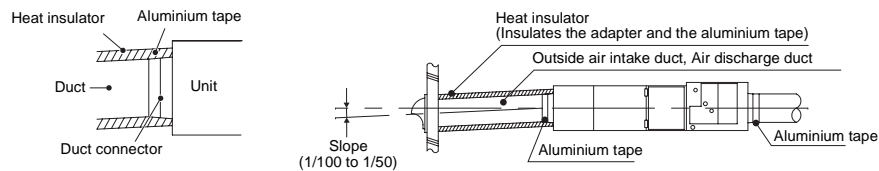

- 5 Insulate 2 ducts to the outside and the SA (supply air) using a heat insulator to prevent condensation.

(Material of insulator: glass wool, 25 mm thick)

### NOTE

- Refrain from the following duct installation works.

- 1) Excessive bending
- 2) Multi-times bending
- 3) Making the connecting duct smaller
- 4) Bending near the exhaust air duct



- When metallic ducts pass through a wooden construction covered with a metal lath, wire lath, or metal plate, install the ducts so that they are not electrically in contact with the metal parts of wooden construction.
- Keep the temperature in the ceiling cavity at 5 °C or more; otherwise, freezing and water leakage may occur due to the built-in humidifier. (VNK type only)
- Even while the unit is not in operation, outside air may enter the room due to a pressure difference between the outside air and inside air, or outside wind. Using an electric damper is recommended.
- Install a ventilator in the ceiling cavity when it is hot and the humidity is high.
- When the outdoor hood for the air intake is located near a window and small insects gather around the light, they may get through the pipes and enter the room. Before installation, consider countermeasures such as setting up a filter box (Locally procured).
- Arrange the pipes so that supply air and exhaust air are not mixed.
- When a vent cap or a round hood for an outdoor hood is used, do not attach the hood to a place where rain may fall directly. In this case, using a rectangle hood is recommended.
- Stuff the cracks in the pipe penetration part with a noncombustible material such as mortar.

## 9 Refrigerant Piping and Vacuuming

### WARNING

- Ventilate the room if a refrigerant gas is leaking during the installation work.

If the leaking refrigerant gas comes in contact with fire, a toxic gas is generated.

- After installation, confirm that no refrigerant gas is leaking.

If the leaking refrigerant gas comes in contact with fire from a fan heater, a stove, or a gas range, a toxic gas is generated.

### NOTE

When the refrigerant pipe is long, provide support brackets at intervals of 2.5 - 3 m to clamp the refrigerant pipe. Otherwise, abnormal sound may be generated.

Use the flare nut attached with the indoor unit or R410A flare nut.

### ■ Permissible piping length and height difference

They vary depending on the outdoor unit.

For details, refer to the Installation Manual attached to the outdoor unit.

### ■ About the pipe material and size

Pipe material	Seamless phosphorous-deoxidized copper pipe			
Model name	MMD-	VNK502HEXE VN502HEXE	VNK802HEXE VN802HEXE	VNK1002HEXE(2) VN1002HEXE(2)
Pipe size (mm)	Gas side	Ø9.5	Ø12.7	Ø12.7
	Liquid side	Ø6.4	Ø6.4	Ø6.4

### ■ Refrigerant piping at the liquid / gas side

#### Flaring

- 1 Cut the pipe with a pipe cutter.

Remove burrs completely.

Remaining burrs may cause gas leakage.

- 2 Insert a flare nut into the pipe, and flare the pipe.

As the flaring sizes of R410A differ from those of refrigerant R22, the flare tools newly manufactured for R410A are recommended.

However, the conventional tools can be used by adjusting projection margin of the copper pipe.

#### Projection margin in flaring: B (Unit: mm)

Rigid (Clutch type)

Outer dia. of copper pipe	R410A tool used	Conventional tool used
6.4, 9.5	0 to 0.5	1.0 to 1.5
12.7		

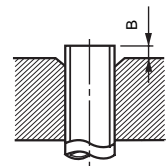

**Flaring dia. meter size: A (Unit: mm)**

Outer dia. of copper pipe	A <sup>+0</sup> / <sub>-0.4</sub>
	R410A
6.4	9.1
9.5	13.2
12.7	16.6

\* In case of flaring for R410A with the conventional flare tool, pull it out approx. 0.5 mm more than that for R22 to adjust to the specified flare size. The copper pipe gauge is useful for adjusting projection margin size.



- The pressure of gas in the unit is the same as the atmospheric pressure. Therefore, no air leaking sound comes out when the flare nut is loosened. This is not anything unusual.
- Use 2 wrenches to perform piping of indoor units.



- Refer to the table below for tightening torque.

Outer diameter of connecting pipe (mm)	Tightening torque (N•m)
Ø6.4	14 to 18 (1.4 to 1.8 kgf•m)
Ø9.5	33 to 42 (3.3 to 4.2 kgf•m)
Ø12.7	50 to 62 (5.0 to 6.2 kgf•m)

**Tightening torque of flare pipe connections**

Pressure of R410A is higher than that of R22.

(Approx. 1.6 times) Therefore, using a torque wrench, tighten the flare pipe connecting sections which connect the indoor and outdoor units of the specified tightening torque.

Incorrect connections may cause not only a gas leak, but also a trouble of the refrigeration cycle.

**REQUIREMENT**

Tightening with an excessive torque may crack the nut depending on installation conditions. Tighten the nut within the specified tightening torque.

**Leak check test and vacuuming**

Refer to the Installation Manual of the outdoor unit for leak check test, vacuuming, adding a refrigerant, or checking gas leakage.

**REQUIREMENT**

Do not turn on the indoor unit before leak check test and vacuuming are finished; otherwise, the electric expansion valve is closed fully and vacuuming from the liquid or gas side is not performed properly. If the indoor unit should be turned on, perform vacuuming from both the liquid side and the gas side.

**Opening the valve fully**

Open the valves of the designated outdoor unit fully.

**Heat insulation**

Apply heat insulation for the pipes separately at liquid side and gas side.

- For the heat insulation to the pipes at gas side, be sure to use the material with heat-resisting temperature 248 °F (120 °C) or higher.
- Using the attached heat insulation material, apply the thermal insulation to the pipe connecting section of the indoor unit securely without gap.

**REQUIREMENT**

- Apply the heat insulation to the pipe connecting section of the indoor unit securely up to the root without exposure of the pipe. (The pipe exposed to the outside causes water leak.)
- Wrap heat insulator with its slits facing up (ceiling side).

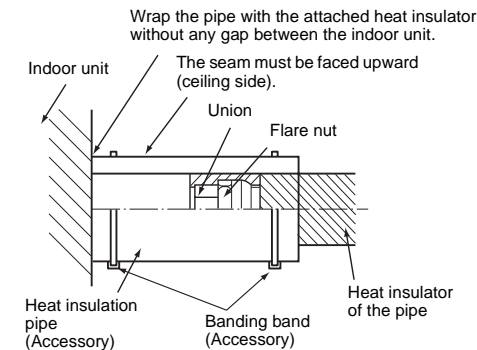

# 10 Electric Wiring

## ⚠ WARNING

- Use predefined wires and connect them certainly. Keep the connecting terminals free from external force. Improper wire connection or clamping may result in exotherm, fire or malfunction.
- Connect earth wire. (grounding work) Incomplete grounding cause an electric shock. Do not connect ground wires to gas pipes, water pipes, lightning rods or ground wires for telephone wires.
- The electric work must satisfy all local, national and international regulations. Use an exclusive power supply circuit for the unit at the rated voltage. Capacity shortage of power circuit or incomplete installation may cause an electric shock or a fire.

## ⚠ CAUTION

Be sure to install an earth leakage breaker. If an earth leakage breaker is not installed, an electric shock may be caused.

## REQUIREMENT

- Perform electrical wiring according to local regulations of each region.
- Perform electrical wiring of the outdoor unit according to the Installation Manual of the outdoor unit.
- Do not connect 220-240 V power to the communication terminal blocks (U, U, A, B) for control wiring. (Otherwise, the system will fail.)
- Perform electrical wiring so that wires do not come in contact with hot parts of the pipes; otherwise, heat from the pipes melts the covering of wires and an accident may result.
- After connecting wires to the terminal blocks, provide a trap and fix wires with the cord clamp.
- Arrange the transition wiring and the refrigerant piping so that they are in the same group.
- Do not turn on the indoor unit before vacuuming of refrigerant piping is finished.

## ■ Power specifications

Wiring and remote controller wire should be locally procured. See the table below for the power specifications. If the capacity is too small, the unit will suffer from overheating or burnout. Refer to the Installation Manual of the outdoor unit for the power capacity or electric wire specifications of the outdoor unit.

Model name MMD-	Item	Power supply for Air to Air Heat Exchanger with DX Coil Unit (*1)		
		Power supply		Wiring for the power supply
Air to Air Heat Exchanger with DX Coil Unit	VNK502HEXE VN502HEXE VNK802HEXE VN802HEXE	I-phase 50 Hz 220-240 V I-phase 60 Hz 220 V	Current rating (Fuse rating) of circuit breaker (switch) for indoor units should be selected by the accumulated total current values of the indoor units.	cable 3-core 2.5 mm <sup>2</sup> , in conformity with Design 60245 IEC66
	VNK1002HEXE VN1002HEXE	I-phase 50 Hz 220-240 V		
	VNK1002HEXE2 VN1002HEXE2	I-phase 60 Hz 220 V		

(\*1)  
• For the power supply of the indoor unit, prepare the exclusive power supply separated from that of the outdoor unit.

Model name MMD-	Item	Communication line	
		Indoor / Outdoor inter-unit wiring (*2) (2 cables) Central control line wiring (*3) (2 cables)	Remote controller wiring (*4)
Air to Air Heat Exchanger with DX Coil Unit	VNK502HEXE VN502HEXE VNK802HEXE VN802HEXE VNK1002HEXE VN1002HEXE VNK1002HEXE2 VN1002HEXE2	(Up to 1000 m) 2-core, non-polarity shield wire: 1.25 mm <sup>2</sup> (Up to 2000 m) 2-core, non-polarity shield wire: 2.00 mm <sup>2</sup>	2-core, non-polarity: 0.5 to 2.0 mm <sup>2</sup>

- (\*2) (\*3)  
• 2-core with non-polarity wires are used for the Indoor / Outdoor inter-unit wiring and Central controller wiring.  
• To prevent noise trouble, use 2-core shield wire.  
• The length of the communication line means the total length of the inter-unit wire length between indoor and outdoor units added with the central control system wire length.
- (\*4)  
• 2-core with non-polarity wire is used for wiring of the remote controller wiring and group remote controllers wiring.

Remote controller wiring, remote controller inter-unit wiring	2-core, non-polarity: 0.5 mm <sup>2</sup> to 2.0 mm <sup>2</sup>
---	--

Total wire length of remote controller wiring and remote controller inter-unit wiring = L + L <sub>1</sub> + L <sub>2</sub> + ... L <sub>n</sub>	For wired type only	Up to 500 mm
	When wireless type is included	Up to 400 mm
Total wire length of remote controller inter-unit wiring = L <sub>1</sub> + L <sub>2</sub> + ... L <sub>n</sub>		Up to 200 mm

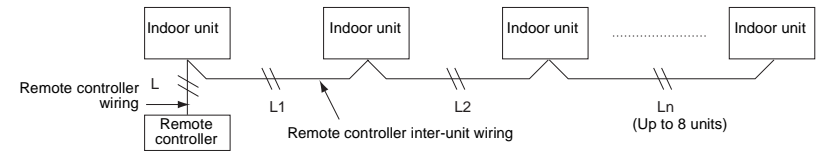

On the outside of the unit, do not allow the wire for the remote controller (communication wire) and the wire for AC220-240 V to come into contact or put them together in one electrical conduit; otherwise, the control system may have trouble due to noise.

### ■ Connection diagram

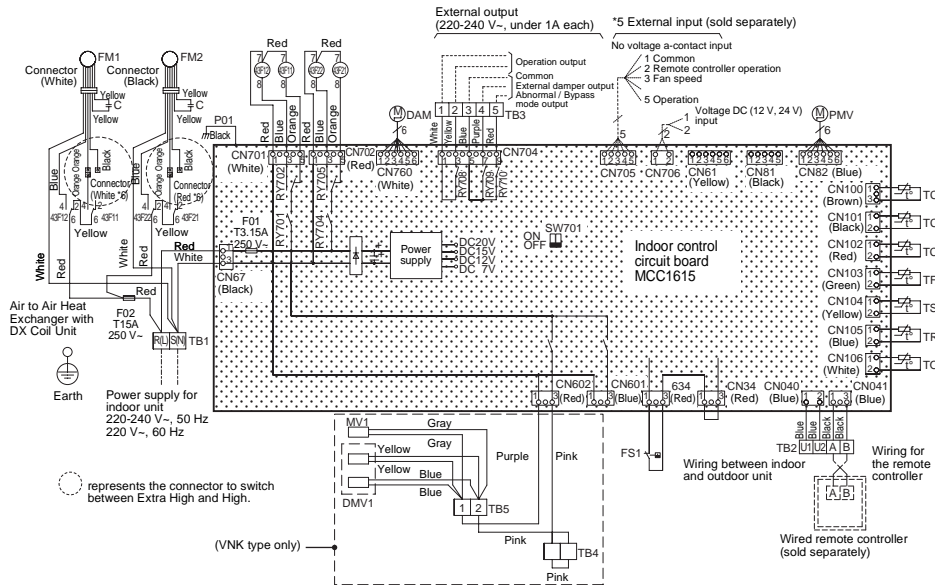

Code	Parts name	Code	Parts name	Code	Parts name
CN***	Connector	TFA	TFA sensor	DMV1 *1	Decompression magnetic valve
F01	Fuse (Printed circuit board)	TCJ, TC1, TC2	Indoor coil sensor	PMV	Pluse modulating valve
F02	Fuse (Motor)	TB1	Terminal block (power source)	SW701	DIP switch
FM1	Air supplying motor	TB2	Terminal block (communication)	43F11, 43F12	Relay for air supplying motor
FM2	Air exhausting motor	TB3	Terminal block (external output)	43F21, 43F22	Relay for air exhausting motor
DAM	Damper motor	TB4 *1	Terminal block (Humidistat)	RY701, RY702	Relay for air supplying motor
TRA	TRA sensor	TB5 *1	Terminal block (Magnetic valve)	RY704, RY705	Relay for exhausting motor
TOA	TOA sensor	FS1	Float switch		
TSA	TSA sensor	MV1 *1	Magnetic Valve		

\*1: VNK type only

- The dotted line represents a wire procured locally, and the dashed line represents an option sold separately.
- represents a terminal block, —○— represents a connection terminal, □○ represents a connector on the printed circuit board and □○ represents a short circuit connector.
- ⊕ represents a protective earth.
- represents a printed circuit board.
- Using a no voltage a-contact input of the external input (sold separately), the following operations are available:  
 Between 1 and 2: Selecting the remote controller operation (Invalid / Valid)  
 Between 1 and 3: Adjusting the fan speed (Low / High)  
 Between 1 and 5: Operation (ON/OFF)  
 Use a microcurrent contact (DC12 V, 1 mA). In addition, ON/OFF operation is possible when using a voltage of DC12 V or 24 V.
- Orange wire (High) is connected as factory default. To switch to "Extra High", connect black wire's connector instead of orange.
- The unit cannot run when the temperature of the outdoor air is below -15 °C.

### ■ Switches and connectors on the circuit board

Remove the 4 screws to detach the cover.

\* Refer to "Advanced System" for how to set the switch.

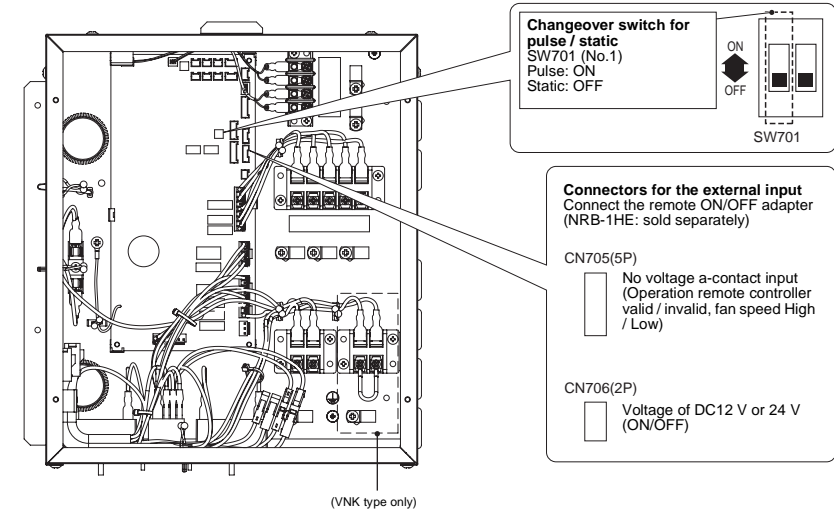

## Wiring connection

### NOTE

- When performing transition wiring for the remote controllers, polarity is not needed to be considered when connecting wires to the terminal A and B on the indoor unit terminal block.
- Leave an extra length of 100 mm for each wiring so that servicing can be performed more easily.
- Low voltage circuit is applied for the remote controller.

Perform wiring so that each wire corresponds with the proper terminal number; otherwise, an electrical fault may occur.

### Wiring in the electrical control box of the indoor unit

Fix the wires using a cord clamp. Do not stretch them tight for wiring.

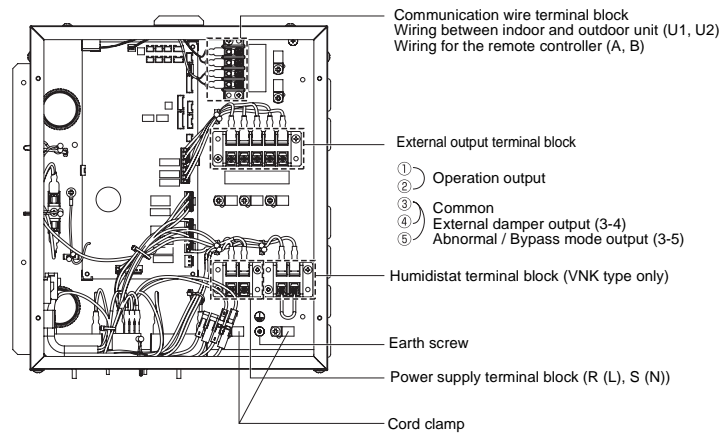

## Wiring the indoor unit

Connect the wire matching the terminal numbers.  
Incorrect connection causes a trouble.

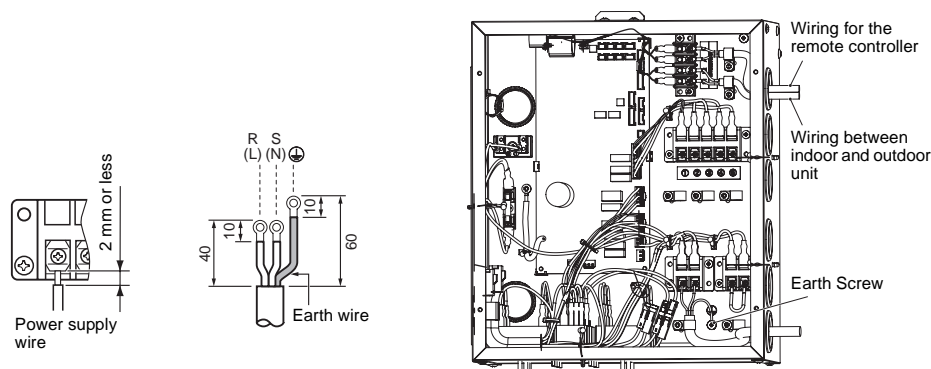

## Remote controller wiring

### Wiring diagram

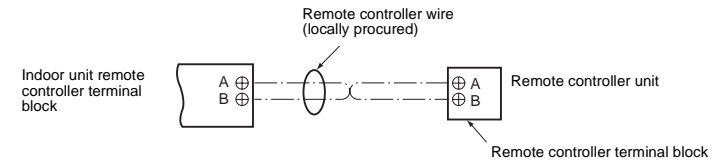

\* Use a 0.5 mm<sup>2</sup> to 2 mm<sup>2</sup> wire.

## Address setting

Refer to the Installation Manual of the outdoor unit for address setting.

\* When the Air to Air Heat Exchanger with DX Coil Unit system linked with indoor air conditioners is used, set the Air to Air Heat Exchanger with DX Coil Unit as "Follower", referring to "Setting the address manually using the remote controller" in the Installation Manual of the outdoor unit.

## Switching between Extra High and High

When switching to Extra High, connect the black lead wire (Extra High) to the connector.

\* The Orange lead wire (High) is connected as factory default.

\* Connect the black lead wire both to the air supplying motor (white connector) and the air exhausting motor (red connector).

\* Refer to "Connection diagram" for the connection method.

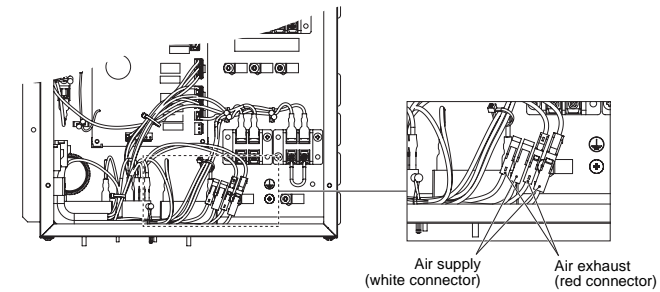

## Wiring between indoor and outdoor units

**NOTE**

An outdoor unit connected with control wiring between indoor and outdoor units wire becomes automatically the header unit.

### Wiring example

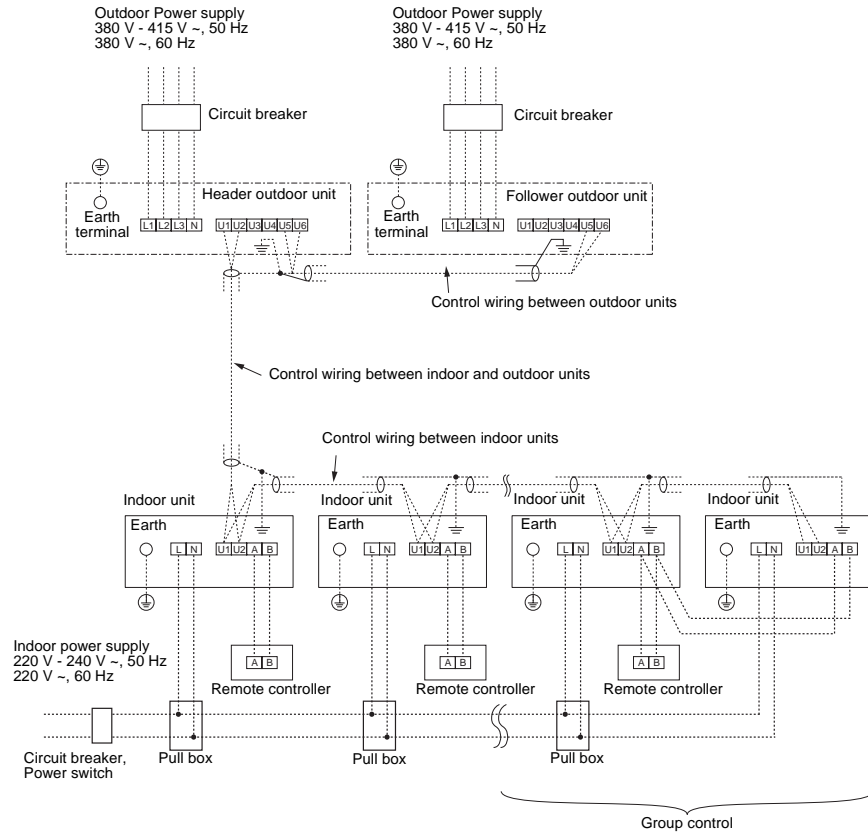

# 11 System Configuration

Settings and electric wiring differ depending on the system configuration. Perform electric wiring according to the system examples shown in the table below.

System example	Operation
<p><b>A. Air to Air Heat Exchanger with DX Coil Unit system</b></p>	<p>You can use the remote controller to ON/OFF running the Air to Air Heat Exchanger with DX Coil Unit.</p> <p><b>Remote controller for the Air to Air Heat Exchanger with DX Coil Unit (NRC-01HE)</b></p> <p>You can select the operation mode, start and stop the unit, control the ventilation FAN speed, select the ventilation mode, and adjust the temperature.</p> <p><b>Main remote controller (RBC-AMT32E)</b></p> <ul style="list-style-type: none"> <li>You can select the operation mode, start and stop the unit, and adjust the temperature.</li> <li>You cannot change the ventilation FAN speed or ventilation mode.</li> </ul> <p><b>If two remote controllers are used, the latter operation overrides the former and their indications always reflect the result of the latter operation.</b></p>
<p><b>B. Air to Air Heat Exchanger with DX Coil Unit system linked with air conditioners</b></p>	<p>You can use the remote controller to ON/OFF running Air conditioners and Air to Air Heat Exchanger with DX Coil Unit.</p> <p><b>Remote controller for the Air to Air Heat Exchanger with DX Coil Unit (NRC-01HE)</b></p> <p>You can select the operation mode, start and stop the unit, control the ventilation FAN speed, select the ventilation mode, and adjust the temperature.</p> <p><b>Main remote controller (RBC-AMT32E)</b></p> <ul style="list-style-type: none"> <li>You can select the operation mode, start and stop the unit, and adjust the temperature.</li> <li>You cannot change the ventilation FAN speed or ventilation mode.</li> </ul> <p><b>If two remote controllers are used, the latter operation overrides the former and their indications always reflect the result of the latter operation.</b></p> <ul style="list-style-type: none"> <li>You can start and stop only the Air to Air Heat Exchanger with DX Coil Unit in the system using NRC-01HE. For this operation, it is necessary to change the settings.</li> <li>Setting modifications are required for separate control. Refer to "13. Advanced Control" on page 18.</li> <li>When the Air to Air Heat Exchanger with DX Coil Unit system linked with indoor air conditioners is used, set the Air to Air Heat Exchanger with DX Coil Unit as "Follower", referring to "Setting the address manually using the remote controller" in the Installation Manual of the outdoor unit.</li> </ul>

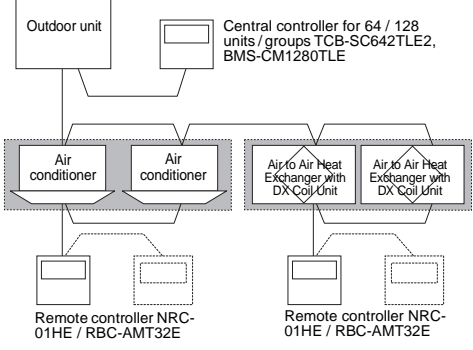
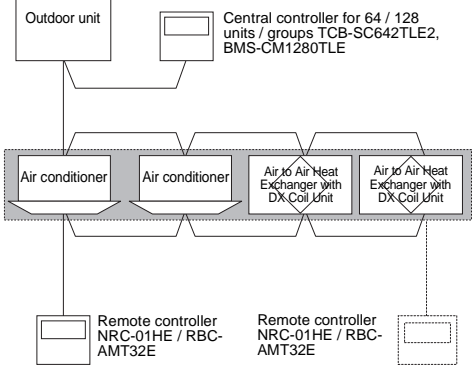
System example	Operation
<p><b>C. Central control system</b> (When controlling groups of air conditioners and the Air to Air Heat Exchanger with DX Coil Unit separately)</p> 	<p>The Central controller can be used to ON/OFF the whole system and separately ON/OFF groups of air conditioners and the Air to Air Heat Exchanger with DX Coil Unit.</p> <p>The Central controller cannot be used to control the ventilation FAN speed or select the ventilation mode of the Air to Air Heat Exchanger with DX Coil Unit.</p> <p>If two remote controllers are used, the latter operation overrides the former and their indications always reflect the result of the latter operation.</p> <ul style="list-style-type: none"> <li>Use NRC-01HE or RBC-AMT32E to control only the group of the Air to Air Heat Exchanger with DX Coil Unit. You cannot control the ventilation FAN speed or select the ventilation mode when using RBC-AMT32E.</li> </ul>
<p><b>D. Central control system</b> (When controlling the Air to Air Heat Exchanger with DX Coil Unit system linked with air conditioners)</p> 	<p>The Central controller can be used to ON/OFF the whole system.</p> <p>The compliant manager cannot be used to control the ventilation FAN speed or select the ventilation mode of the Air to Air Heat Exchanger with DX Coil Unit.</p> <p>You can control the ventilation FAN speed and select the ventilation mode of the Air to Air Heat Exchanger with DX Coil Unit using NRC-01HE.</p> <p>You cannot control the ventilation FAN speed or select the ventilation mode of the Air to Air Heat Exchanger with DX Coil Unit using RBC-AMT32E.</p> <p>If two remote controllers are used, the latter operation overrides the former and their indications always reflect the result of the latter operation.</p> <ul style="list-style-type: none"> <li>You can start and stop only the Air to Air Heat Exchanger with DX Coil Unit in the system using NRC-01HE. For this operation, it is necessary to change the settings.</li> <li>Setting modifications are required for separate control. Refer to "13. Advanced Control" on page 18.</li> <li>When the Air to Air Heat Exchanger with DX Coil Unit system linked with indoor air conditioners is used, set the Air to Air Heat Exchanger with DX Coil Unit as "Follower", referring to "Setting the address manually using the remote controller" in the Installation Manual of the outdoor unit.</li> </ul>

\* The Air to Air Heat Exchanger and the Air to Air Heat Exchanger with DX Coil Unit cannot be used together in the same system.

## ■ Installing two remote controllers for the Air to Air Heat Exchanger with DX Coil Unit

For details on how to install the remote controller for the Air to Air Heat Exchanger with DX Coil Unit, refer to the Installation Manual accessory with the remote controller.

You can control one or multiple Air to Air Heat Exchanger with DX Coil Unit(s) using two remote controllers. (Up to two remote controllers can be installed.)

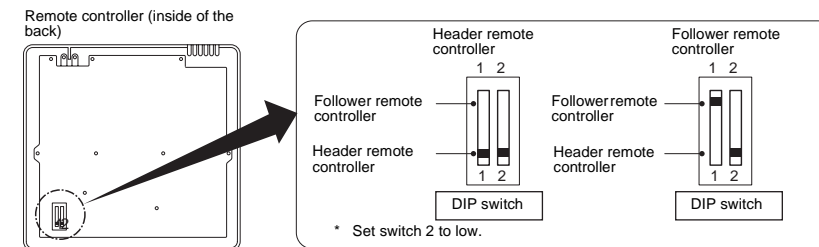

### How to install

When you want to use two remote controllers, follow the procedure below.

1. Set one remote controller as the header (factory default).
2. Set the other remote controller as the follower using the DIP switch. After that, the remote controller works as the follower.



# 12 Advanced System

## WARNING

- Use wiring that meets the specifications in the Installation Manual and the stipulations in the local regulations and laws. Use of wiring which does not meet the specifications may give rise to electric shocks, electrical leakage, smoking and / or a fire.
- When carrying out electric connection, use the wire specified in the Installation Manual and connect and fix the wire securely to prevent them applying external force to the terminals. Improper connection of fixing may result in fire.
- Electrical wiring work shall be conducted according to law and regulation in the community and Installation Manual. Failure to do so may result in electrocution or short circuit.

## REQUIREMENT

For the connecting procedure and electric wiring of External Input (sold separately), refer to the Installation Manual of Remote ON / OFF Adapter NRB-1HE.

### 1 Connecting to external devices by using remote control interface.

- Air to Air Heat Exchanger with DX coil unit receives ON-OFF signal from external devices such as central remote control. (Command) Air to Air Heat Exchanger with DX coil unit concurrently sends operating status signal (operating display, error display). (Reply)

#### 1) Connecting diagram

TCB-IFCB-4E2

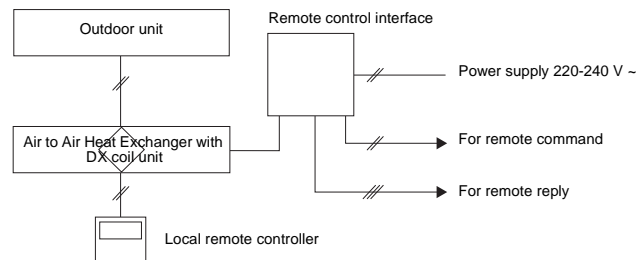

#### 2) Operating status display for remote control

TCB-IFCB-4E2

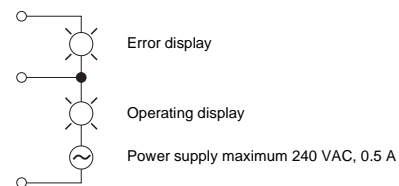

#### 3) Correspondence to ON-OFF signal from remote control

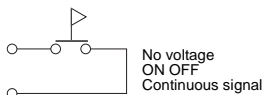

#### 4) Control priority type can be selected between remote priority control and last command priority control

## 2 Switching the remote controller between invalid / valid or low / high from an external device (separately sold External Input)

- Perform connection with one of the units in the group.
- Static signal only

Insert the remote ON/OFF adapter NRB-1HE (sold separately) into connector CN705.

- Transmission wire used to extend must be locally procured: Non-polarity, shielded wire (H05 VVC4V5-K or 60227 IEC 74) 0.5 mm<sup>2</sup>  
Maximum length: 50 m

If a polar contact such as a photocoupler is used with a no voltage a-contact, connect the positive pole to terminal (2), (3) or (4) and the negative pole to terminal (1).	Specification of the external contact: Contact for microcurrent DC12 V 1 mA
---	---

### 1) When switching the remote controller between invalid / valid from an external device

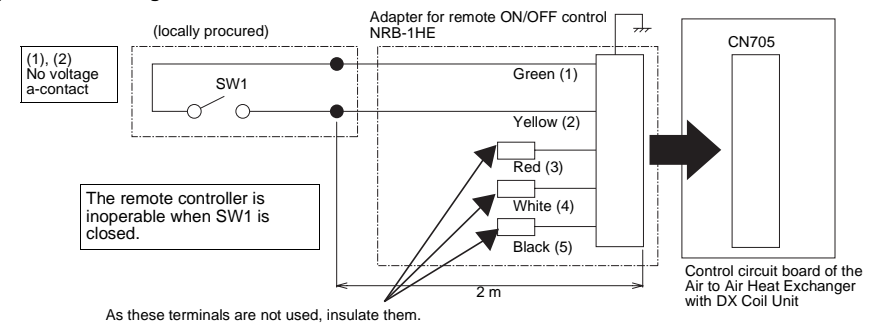

#### SW1 [Remote controller Invalid: ON, Valid: OFF]

- For NRC-01HE (remote controller for the Air to Air Heat Exchanger with DX Coil Unit), when one of the buttons below is pressed, the remote controller blinks and the operation is invalid.
  - \* [ON/OFF] button
  - \* [VENT] button
  - \* [VENT MODE] button
  - \* [VENT FAN] button
- For RBC-AMT32E (remote controller for the air conditioner), pressing the [ON/OFF] button has no effect.
- When the remote controller is inoperable, nighttime heat purge operation are not available.
- If a command is sent to one of the units in the group, the invalid / valid setting of the remote controller in the group can be switched.

2) When switching between low / high from an external device

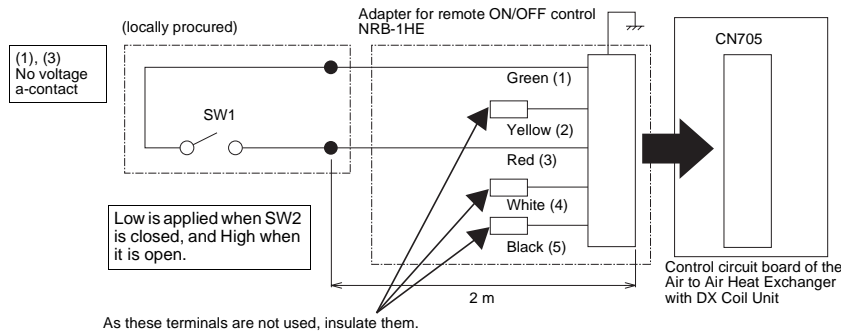

SW2 [Low: ON, High: OFF]

- For NRC-01HE (remote controller for the Air to Air Heat Exchanger with DX Coil Unit), the message on the display is changed. However, when the air conditioner operates Air to Air Heat Exchanger with DX Coil Unit system linked with air conditioners, ventilation fan speed (Low / High) is changed though the ventilation amount is not shown on the display.
- If a command is sent to one of the units in the group, all the Air to Air Heat Exchanger with DX Coil Units in the group operate together.
- The latter operation of the remote controller or the external device overrides the former.

3 Connecting an auxiliary fan or monitoring operation output (External Output)

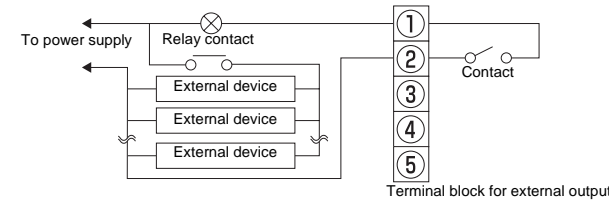
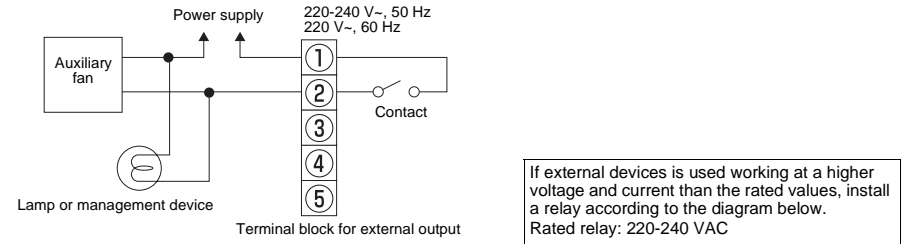

Connect to the terminal block for external output (1 and 2) in the electrical control box  
 Connection wire (locally procured): 2-core wire (H07 RN-F or 60245 IEC 66) 1.0 mm<sup>2</sup> to 2.5 mm<sup>2</sup>

Rated contact	
Maximum: 240 VAC, 1 A	24 VDC, 1 A
Minimum: 220 VAC, 100 mA	5 VDC, 100 mA

Contact is on during normal operation as factory default.

- Contact is off during nighttime heat purge operation or while fan operation is off to protect the unit.
- The operation output settings can be changed. Refer to "Setting for changing the operation output" on page 21.

4 Connecting an electric damper (electric shutter) (External Output)

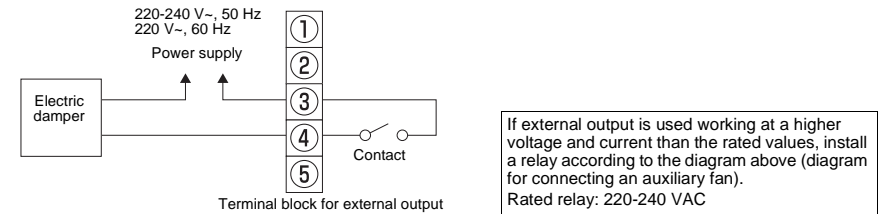

Connect to the terminal block for external output (3 and 4) in the electrical control box  
 Connection wire (locally procured): 2-core wire (H07 RN-F or 60245 IEC 66) 1.0 mm<sup>2</sup> to 2.5 mm<sup>2</sup>

Rated contact (3 to 5: Total value with abnormal signal output)	
Maximum: 240 VAC, 1 A	24 VDC, 1 A
Minimum: 220 VAC, 100 mA	5 VDC, 100 mA

The electric damper (electric shutter) works during normal operation, and nighttime heat purge operation.

- The electric damper (electric shutter) also works in the following circumstances:
  - While the operation is paused during nighttime heat purge operation
  - While operating in cold mode (Temperature is below  $-10^{\circ}\text{C}$ .)
- The electric damper (electric shutter) does not work in the following circumstances:
  - While the operation is stopped
  - Before the monitoring operation of nighttime heat purge operation starts

## 5 Monitoring an abnormal signal or the operation signal of bypass mode (External Output)

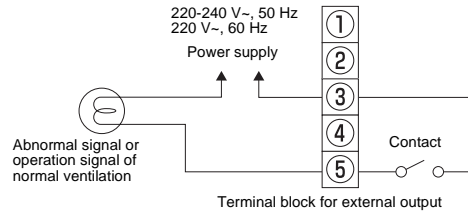

Connect to the terminal block for external output (3 and 5) in the electrical control box

Connection wire (locally procured): 2-core wire (H07 RN-F or 60245 IEC 66) 1.0 mm<sup>2</sup> to 2.5 mm<sup>2</sup>

Rated contact (3 and 4: Total value with output of the electric damper)

Maximum: 240 VAC, 1 A	24 VDC, 1 A
Minimum: 220 VAC, 100 mA	5 VDC, 100 mA

It is possible to monitor an abnormal signal or the operation signal of bypass mode from the Air to Air Heat Exchanger with DX Coil Unit.

Detection of an abnormal signal is possible, as factory default.

- To change settings so that the operation signal of bypass mode can be detected, refer to "Abnormal signal / bypass mode signal output setting" on page 22.

## 6 Connecting a humidistat, etc. (VNK type only)

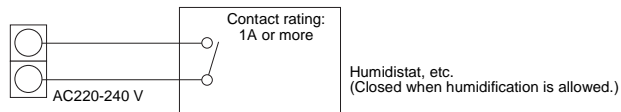

Remove the short wires fixed on the terminal block TB4 with screws. (You need not use these wires.)

Connect a humidistat, etc. to the terminal block using the screws.

# 13 Advanced Control

## REQUIREMENT

When using the Air to Air Heat Exchanger with DX Coil Unit for the first time, it will take some moments after the power has been turned on before the remote controller becomes available for operations: This is normal and is not indicative of trouble.

- Concerning the automatic addresses (The automatic addresses are set up by performing operations on the outdoor interface circuit board.)

While the automatic addresses are being set up, no remote controller operations can be performed. Setup takes up to 10 minutes (usually about 5 minutes).

- When the power is turned on after automatic address setup

It takes up to 10 minutes (usually about 3 minutes) for the outdoor unit to start operating after the power has been turned on.

Before the Air to Air Heat Exchanger with DX Coil Unit was shipped from the factory, all units are set to [STANDARD] (factory setting). If necessary, change the indoor unit settings.

The settings are changed by operating the wired remote controller.

- The settings cannot be changed using only a wireless remote controller, simple remote controller or group control remote controller by itself so install a wired remote controller separately as well.

## Changing the advanced control settings

### Basic procedure for changing the settings

Change settings while the power is turned off. (Be sure to stop operation.)

### CAUTION

Do not change any setting codes other than those in this manual; otherwise, the unit may not work or some problems may occur.

### Changing the settings of the Air to Air Heat Exchanger with DX Coil Unit (For NRC-01HE)

- For RBC-AMT32E, you can change settings using the same procedure as NRC-01HE. (Display position is different from that of NRC-01HE.)

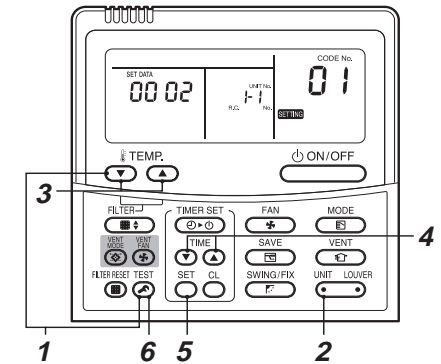

## 1 Push **TEST** button and temp. setup **TEMP.** button simultaneously for at least 4 seconds.

After a while, the display flashes as shown in the figure.

Confirm that the CODE No. is [01].

- If the CODE No. is not [01], push **TEST** button to erase the display content, and repeat the procedure from the beginning. (No operation of the remote controller is accepted for a while after **TEST** button is pushed.) (While Air to Air Heat Exchanger with DX Coil Unit are operated under the group control, "ALL" is displayed first. When **UNIT LOUVER** is pushed, the indoor unit number displayed following "ALL" is the header unit.)

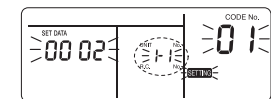

(\* Display content varies with the indoor unit model.)

## 2 Every time you press the **UNIT LOUVER** button, the unit numbers of the indoor units or the Air to Air Heat Exchanger with DX Coil Units in the group are displayed successively. Select the Air to Air Heat Exchanger with DX Coil Unit to change settings. When the unit is selected, the fan starts running to indicate which unit you have selected.

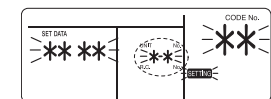

## 3 Using **TEMP. setup** **TEMP.** / **TEMP.** buttons, specify CODE No. [ \*\* ].

**4** Using TIMER time  $\nabla$  /  $\triangle$  buttons, select SET DATA [\*\*\*\*].

**5** Push  $\text{SET}$  button. When the display changes from flashing to lit, the setup is completed.

- To change settings of another indoor unit, repeat from Procedure 2.
- To change other settings of the selected indoor unit, repeat from Procedure 3.  
Use  $\text{SET}$  button to clear the settings.  
To make settings after  $\text{SET}$  button was pushed, repeat from Procedure 2.

**6** When settings have been completed, push  $\text{TEST}$  button to determine the settings.

When  $\text{TEST}$  button is pushed, "SETTING" flashes and then the display content disappears and the air conditioner enters the normal stop mode.

(While "SETTING" is flashing, no operation of the remote controller is accepted.)

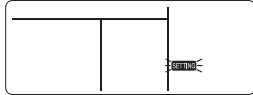

### Codes (DN codes) for changing settings

Codes in the table below are necessary for local advanced control.

Code	Description	SET DATA and description	Factory default	Note
01	Lighting-up hours of the Filter Sign	0000: None 0001: 150 H 0002: 2500 H 0003: 5000 H 0004: 10000 H	0002: 2500 H	Adjusting this setting is necessary for the header unit.
06	Detect temperature shift value when heating	0000: No shift 0001 - 0006: [SET DATA value] × 1 °C shift	0002: 2 °C shift	
31	Single operation of the fan	0000: Invalid 0001: Valid ON/OFF operation for the Air to Air Heat Exchanger with DX Coil Unit only	0000: Invalid	Adjusting this setting is necessary for the header unit. (System equipped with the Air to Air Heat Exchanger with DX Coil Unit and air conditioners)
32	Remote controller sensor	0000: Do not use 0001: Use	0000: Do not use	
48	Unbalanced ventilation Fan speed	0000: Normal 0001: SA (High) > EA (Low) active 0002: SA (Low) < EA (High) active * "High" may be "Extra High".	0000: Normal	Adjusting this setting is necessary for all the Air to Air Heat Exchanger with DX Coil Units in the group.
4C	Nighttime heat purge	0000: Invalid 0001-0048: Start after [Setting value] x 1 hour(s) * Setting for the time before the nighttime heat purge operation starts	0000: Nighttime heat purge OFF	Adjusting this setting is necessary for all the Air to Air Heat Exchanger with DX Coil Units in the group. (System equipped with the Air to Air Heat Exchanger with DX Coil Unit and air conditioners)
4E	Setting of the linked operation with external devices	0000: ON/OFF linked 0001: ON linked 0002: OFF linked * Specifies whether the ON/OFF operation of the Air to Air Heat Exchanger with DX Coil Unit is linked with the external device operation	0000: ON/OFF linked	Adjusting this setting is necessary for a Air to Air Heat Exchanger with DX Coil Unit to which an adapter for remote ON/OFF control (sold separately) is connected.
EA	Changing the ventilation mode	0002: Heat Exchange mode 0003: Automatic mode * Compatible with systems without a remote controller and RBC-AMT32E	0003: Automatic mode	*1
EB	Changing the ventilation Fan speed	0002: High 0003: Low 0004: Unbalanced * "High" may be "Extra High". * Compatible with systems without a remote controller and RBC-AMT32E	0002: High	*1
ED	Changing the operation output	0000: ON during normal operation 0001: ON during normal operation or nighttime heat purge operation 0002: ON during nighttime heat purge operation 0003: ON when SA fan is running 0004: ON when EA fan is running	0000: ON during normal operation	Adjusting this setting is necessary for a Air to Air Heat Exchanger with DX Coil Unit which transfers the operation output.
EE	Changing the abnormal signal / Bypass mode signal output	0000: ON when an abnormal signal is detected 0001: ON when the Bypass mode signal is detected	0000: ON when an abnormal signal is detected	Adjusting this setting is necessary for a Air to Air Heat Exchanger with DX Coil Unit which transfers the operation output.

\* Adjusting this setting is necessary for the header unit when using a system equipped with the Air to Air Heat Exchanger with DX Coil Unit only, and the Air to Air Heat Exchanger with DX Coil Unit with the smallest indoor unit address number when using a system equipped with the Air to Air Heat Exchanger with DX Coil Unit and air conditioners.

## ■ Group control

In a group control, a remote controller can control up to maximum 8 units.

- For wiring procedure and wiring method of the individual line (Identical refrigerant line) system, refer to "Electric Wiring" in this Manual.
- Wiring between indoor units in a group is performed in the following procedure. Connect the indoor units by connecting the remote controller inter-unit wires from the remote controller terminal blocks (A/B) of the indoor unit connected with a remote controller to the remote controller terminal blocks (A/B) of the other indoor unit. (Non-polarity)
- For address setup, refer to the Installation Manual attached to the outdoor unit.

## ■ Changing the time before the Filter Sign lights up

The time before the Filter Sign lights up can be changed according to the installation conditions.

- \* Adjust this setting for the header unit.
  - Select [01] in step 3 on page 18.
  - Select a value from the table on the below in step 4 on page 19 according to the preferred time before the Filter Sign lights up.

Code	SET DATA	0000	0001	0002	0003	0004
01	Time before the Filter Sign lights up	None	150H	2500H (Factory default)	5000H	10000H

## ■ For better heating performance

When it is hard to become hot due to the location of the indoor unit, room structure, etc., you can raise the detect temperature for heating. It is recommended that you use a circulator or the like to circulate warm air around the ceiling.

- Select [06] for CODE NO. in Step 3 on page 18.
- Select CODE NO. from the following table in Step 4 on page 19:

Code	SET DATA	0000	0001	0002	0003	0004	0005	0006
06	Detect temperature Shift value	None	+ 1 °C	+ 2 °C (default)	+ 3 °C	+ 4 °C	+ 5 °C	+ 6 °C

- \* In addition to the above detect temperature shift value, the own detect temperature shift value (Heat: 2.5 °C, Cool: -2.0 °C) is set for the Air to Air Heat Exchanger with DX coil unit in order to intake enough outdoor air. This setting does not need to be changed, but if you want to change the setting, contact our Customer Support Center.

## ■ Setting the single operation of the Air to Air Heat Exchanger with DX Coil Unit (Setting for the header air conditioner)

Single operation of the Air to Air Heat Exchanger with DX Coil Unit is possible when operation of the Air to Air Heat Exchanger with DX Coil Unit is linked with that of the air conditioners.

Use the  button of the wired remote controller.

- \* While the Air to Air Heat Exchanger with DX Coil Unit is in operation,  is displayed on the remote controller.
- \* Adjust this setting for the header air conditioner in the group when using a system equipped with the Air to Air Heat Exchanger with DX Coil Unit and air conditioners.
- \* This setting is invalid when using a system equipped with the Air to Air Heat Exchanger with DX Coil Unit(s) only.
  - Select [31] in step 3 on page 18.
  - Select [0001] in step 4 on page 19.

Code	SET DATA	0000	0001
31	Single operation of the fan	Invalid (Factory default)	Valid

### REQUIREMENT

Do not change this setting when the operation is linked by a signal from an external device or remotely controlled on and off (page 16) by using Remote ON/OFF Adapter NRB-1HE (sold separately).

## ■ Remote controller sensor

Usually the temperature sensor of the indoor unit senses the temperature. Configure this setting in order to sense the temperature around the remote controller.

- Select [32] for CODE NO. in Step 3 on page 18.
- Select CODE NO. from the following table in Step 4 on page 19:

If the remote controller sensor blinks, an error has occurred on the remote controller sensor. Set [0000]: Do not use for the remote controller sensor, or replace the remote controller.

Code	SET DATA	0000	0001
32	Remote controller sensor	Do not use (default)	Use

## ■ Setting of the unbalanced ventilation Fan speed

SA / EA unbalanced operation of the Air to Air Heat Exchanger with DX Coil Unit is possible.

Use the  button of the remote controller.

- \* Adjust this setting for all the Air to Air Heat Exchanger with DX Coil Units when group operation is applied.
- \* Though RBC-AMT32E cannot be used, this setting can still be changed. For details, refer to "Ventilation Fan speed setting" on page 21.
  - Select [48] in step 3 on page 18.
  - Select [0001: SA (High) > EA (Low) active] or [0002: SA (Low) < EA (High) active] in step 4 on page 19.

Code	SET DATA	0000	0001	0002
48	Unbalanced ventilation Fan speed	Invalid (Factory default)	SA (High) > EA (Low) active	SA (Low) < EA (High) active

## ■ Nighttime heat purge setting

Nighttime heat purge exhausts hot air in the room by bypass mode and reduces the cooling load in the morning. Monitoring operation starts after [Setting value] x 1 hour(s). (1 to 48 hours)

- \* Adjust this setting for all the Air to Air Heat Exchanger with DX Coil Units in the group. (Only when the Air to Air Heat Exchanger with DX Coil Unit(s) operates link with air conditioners)
- \* This setting is invalid for a system equipped with the Air to Air Heat Exchanger with DX Coil Unit only.
  - Select [4C] in step 3 on page 18.
  - Select a value from the table on the below in step 4 on page 19 according to the preferred time.

Code	SET DATA	0000	0001 to 0048
4C	Nighttime heat purge	0000: Invalid (Factory default)	Start after [Setting value] x 1 hour(s)

## ■ Setting for linked operation with external devices

Specifies the operation of the Air to Air Heat Exchanger with DX Coil Unit linked with the on/off operation of external devices

- \* For group operation, adjust this setting for the Air to Air Heat Exchanger with DX Coil Unit to which the remote ON/OFF adapter (NRB-1HE: sold separately) is connected.
  - Select [4E] in step 3 on page 18.
  - Select a value from the table on the below in step 4 on page 19.

Code	SET DATA	0000	0001	0002
4E	Linked operation with external devices	ON/OFF linked (Factory default)	ON linked	OFF linked

0000: The Air to Air Heat Exchanger with DX Coil Unit starts / stops together with the starting / stopping of an external device. (The latter operation of the remote controller or the switch of the external device overrides the former.)
0001: The Air to Air Heat Exchanger with DX Coil Unit starts together with the starting of an external device. Use the remote controller to stop operation.
0002: The Air to Air Heat Exchanger with DX Coil Unit stops together with the stopping of an external device. Use the remote controller to start operation.

## ■ Ventilation mode setting

The setting of the ventilation mode can be changed when using the remote controller for air conditioners (RBC-AMT32E).

- \* Adjusting this setting is necessary for the header unit when using a system equipped with the Air to Air Heat Exchanger with DX Coil Unit only (RBC-AMT32E can not be used.), and for the Air to Air Heat Exchanger with DX Coil Unit with the smallest address number when using a system equipped with the Air to Air Heat Exchanger with DX Coil Unit and air conditioners.
- \* When the remote controller NRC-01HE is installed, this setting is invalid. (The remote controller can be used for operation.)
  - Select [EA] in step 3 on page 18.
  - Select a value from the table on the below in step 4 on page 19.

Code	SET DATA	0001	0002
EA	Changing the ventilation mode	Heat Exchange mode	Automatic mode (Factory default)

## ■ Ventilation Fan speed setting

The setting of the ventilation Fan speed can be changed when using the remote controller for air conditioners (RBC-AMT32E, RBC-AMS41E) or using the system without the remote controller.

- \* Adjusting this setting is necessary for the header unit when using a system equipped with the Air to Air Heat Exchanger with DX Coil Unit only (RBC-AMT32E can not be used.), and for the Air to Air Heat Exchanger with DX Coil Unit with the smallest address number when using a system equipped with the Air to Air Heat Exchanger with DX Coil Unit and air conditioners.
- \* When the remote controller NRC-01HE is installed, this setting is invalid. (The remote controller can be used for operation.)
  - Select [EB] in step 3 on page 18.
  - Select a value from the table on the below in step 4 on page 19.

Code	SET DATA	0002	0003	0004
EB	Changing the ventilation amount	High (Factory default)	Low	Unbalanced

- \* When [0004] is selected, adjust setting of the unbalanced ventilation Fan speed (Code: 48).

## ■ Setting for changing the operation output

Terminals 1 and 2 on the terminal block 3 for external devices can be used to connect an auxiliary fan or to use the operation output for operating external devices connected to the terminal. It can be specified when the operation output is used.

- \* Apply this setting for the Air to Air Heat Exchanger with DX Coil Unit to which an external device is connected.
  - Select [ED] in step 3 on page 18.
  - Select a value from the table below in step 4 on page 19.

Code	SET DATA	0000	0001	0002	0003	0004
ED	Changing the operation output	ON during normal operation (Factory default)	ON during normal operation or nighttime heat purge operation	ON during nighttime heat purge operation	ON when SA fan is running	ON when EA fan is running

0000: Contact is on only during normal operation. <ul style="list-style-type: none"> <li>* Contact is off during nighttime heat purge operation.</li> <li>* Contact is off during cold mode (while the temperature is below -10 °C)</li> </ul>
0001: Contact is on during normal operation and nighttime heat purge operation. <ul style="list-style-type: none"> <li>* Contact is off when nighttime heat purge operation is on standby. (paused before the monitoring operation of nighttime heat purge operation starts)</li> <li>* Contact is off during cold mode (while the temperature is below -10 °C)</li> </ul>
0002: Contact is on during nighttime heat purge operation. <ul style="list-style-type: none"> <li>* Contact is off during normal operation or when nighttime heat purge operation is on standby. (paused before the monitoring operation of nighttime heat purge operation starts)</li> <li>* Contact is off during cold mode (while the temperature is below -10 °C)</li> </ul>
0003: Contact is on only when SA fan is running.
0004: Contact is on only when EA fan is running.

- \* Contact is off during switching the damper (Heat exchange mode / Bypass mode) regardless of the selected value.

### Abnormal signal / bypass mode signal output setting

Terminals 3 to 5 for external output can be used to detect an abnormal signal / bypass mode signal output. Output signal to be detected can be selected.

- \* Adjust this setting for the Air to Air Heat Exchanger with DX Coil Unit to which an external output is connected.
- \* When [0000] is selected, signal transfer is on if one of the units in the group has trouble.
  - Select [EE] in step 3 on page 18.
  - Select a value from the table on the below in step 4 on page 19.

Code	SET DATA	0000	0001
EE	Changing the abnormal signal / bypass mode signal output	ON when an abnormal signal is detected (Factory default)	ON when the bypass mode signal is detected

0000: Signal transfer is on when an abnormal signal output is detected.  
 0001: Signal transfer is on when the bypass mode signal output is detected.  
 \* Signal transfer is on during nighttime heat purge operation.  
 \* Signal transfer is off when the nighttime heat purge operation is on standby. (paused before the monitoring operation of the nighttime heat purge operation starts)

# 14 Fan Characteristics

## ◆ MMD-VNK502HEXE

Standard air volume: 500 m<sup>3</sup>/h, Lower limit air volume: 330 m<sup>3</sup>/h, Upper limit air volume: 600 m<sup>3</sup>/h

### 50 Hz 230 V

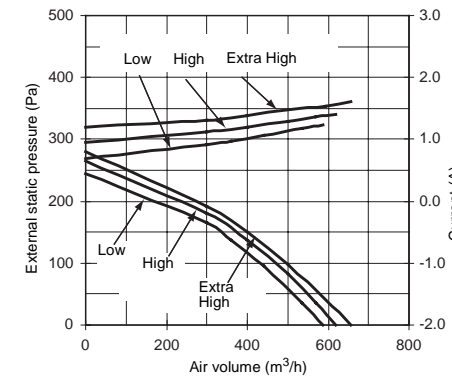

### 60 Hz 220 V

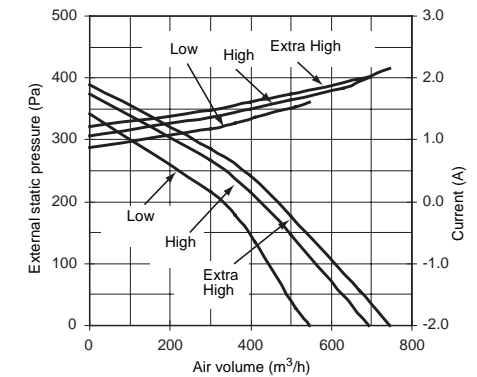

## ◆ MMD-VN502HEXE

Standard air volume: 500 m<sup>3</sup>/h, Lower limit air volume: 330 m<sup>3</sup>/h, Upper limit air volume: 600 m<sup>3</sup>/h

### 50 Hz 230 V

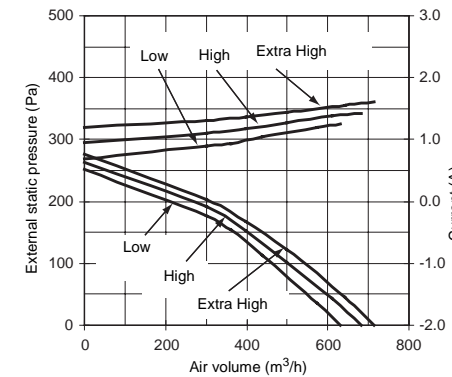

### 60 Hz 220 V

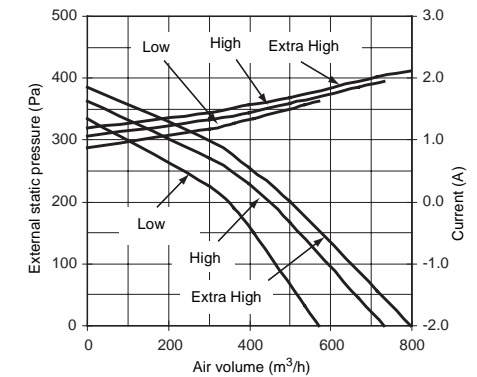

◆ MMD-VNK802HEXE

Standard air volume: 800 m<sup>3</sup>/h, Lower limit air volume: 480 m<sup>3</sup>/h, Upper limit air volume: 960 m<sup>3</sup>/h

50 Hz 230 V

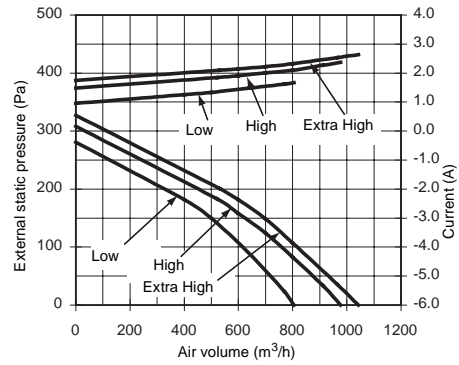

60 Hz 220 V

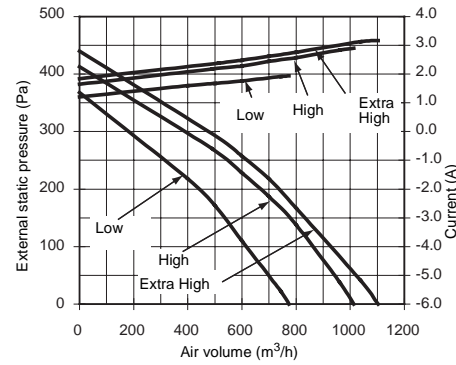

◆ MMD-VNK1002HEXE(2)

Standard air volume: 950 m<sup>3</sup>/h, Lower limit air volume: 640 m<sup>3</sup>/h, Upper limit air volume: 1140 m<sup>3</sup>/h

50 Hz 230 V

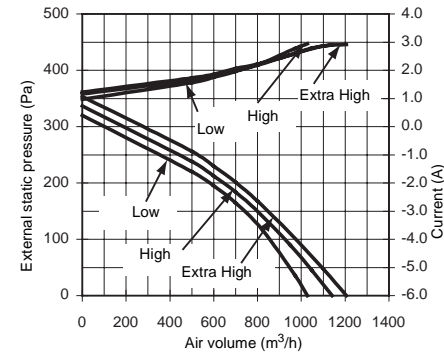

60 Hz 220 V

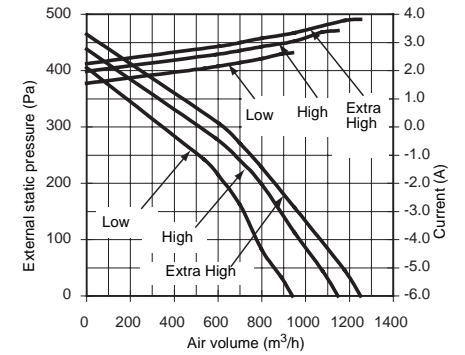

◆ MMD-VN802HEXE

Standard air volume: 800 m<sup>3</sup>/h, Lower limit air volume: 480 m<sup>3</sup>/h, Upper limit air volume: 960 m<sup>3</sup>/h

50 Hz 230 V

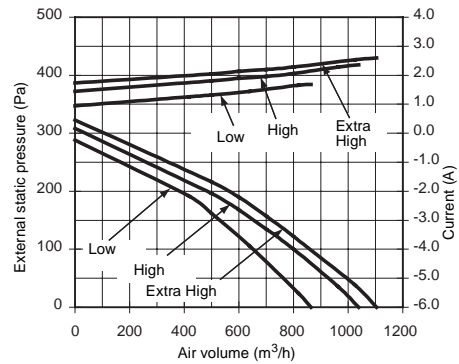

60 Hz 220 V

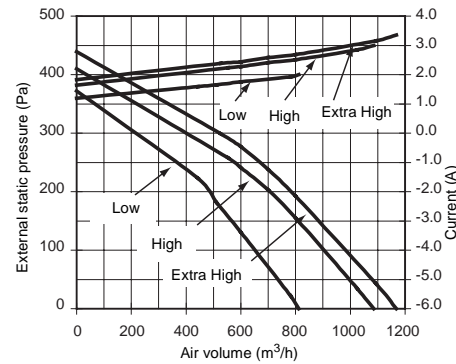

◆ MMD-VN1002HEXE(2)

Standard air volume: 950 m<sup>3</sup>/h, Lower limit air volume: 640 m<sup>3</sup>/h, Upper limit air volume: 1140 m<sup>3</sup>/h

50 Hz 230 V

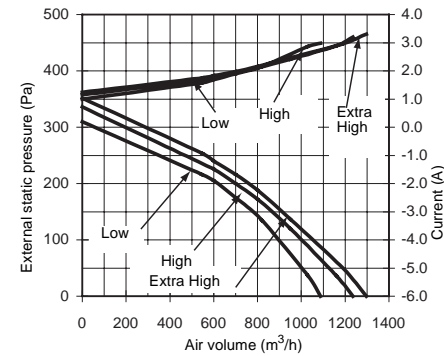

60 Hz 220 V

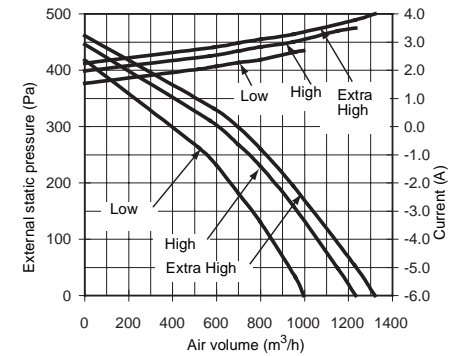

**REQUIREMENT**

Use the unit between the minimum and maximum range of ventilation.



# 15 Test Run

## ■ Before test run

- Before turning on the power supply, carry out the following procedure.
  - Using 500 V-megger, check that resistance of 1 MΩ or more exists between the terminal block of the power supply and the earth (earthing). If resistance of less than 1 MΩ is detected, do not run the unit.
  - Check all valve of the outdoor unit being opened fully.
- To protect the compressor at activation time, leave power-ON for 12 hours or more before operating.
- Do not press the electromagnetic contactor to forcibly perform a test run. (This is very dangerous because the protective device does not work.)
- Before starting a test run, set addresses following the Installation Manual supplied with the outdoor unit.

## ■ How to execute a test run

For the procedure of the operation, refer to the attached Owner's Manual. A forced test run can be executed in the following procedure even if the operation stops by thermo.-OFF. In order to prevent a continuous operation, the forced test run is released after 60 minutes have passed and returns to the usual operation.

### ⚠ CAUTION

Do not use the forced test run for cases other than the test run because it applies an excessive load to the devices.

## Wired remote controller (NRC-01HE)

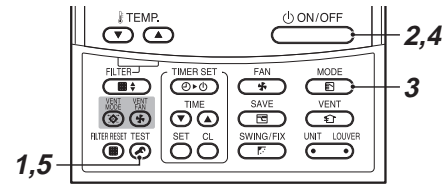

- When the **TEST** button is pressed and held for at least 4 seconds, "TEST" appears on the display, and the test run mode is established. (While the test run is underway, "TEST" remains on the display.)

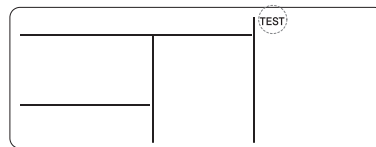

- Push **ON/OFF** button.
- Using **MODE** button, select the operation mode, [**COOL**] or [**HEAT**].
  - The temperature controlling function does not work during test run.
  - The detection of error is performed as usual.

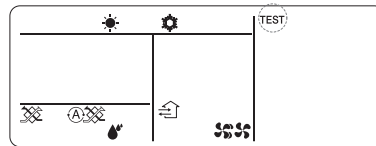

- Use the [**VENT FAN**] button to select "High" or "Low".

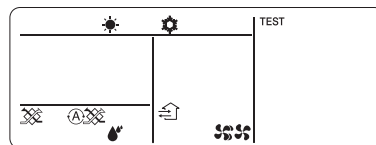

- Use the [**VENT MODE**] button to select "Auto ventilation" or "Total heat exchanging ventilation".

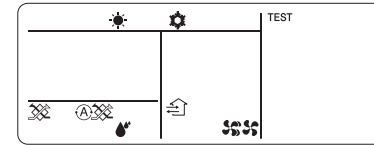

- After the test run, push **ON/OFF** button to stop a test run. (Display part is same as procedure 1.)
- Push **TEST** check button to cancel the test run mode. ([TEST] disappears on the display and the status returns to a normal.)

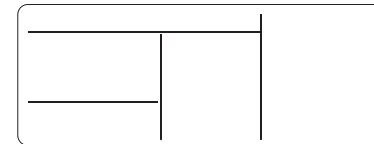

- If the test run is performed when the indoor / outdoor temperature is low, the run may be stopped for device protection. In this case, use another air conditioner or the like to raise the temperature to 20 °C or higher, and then perform the heating operation.

# 16 Maintenance

Turn off the breaker before performing maintenance. Running the Air to Air Heat Exchanger with DX Coil Unit for a long period causes the filter or heat-exchanger element to become clogged with dust. If the filter or heat-exchanger element is clogged, the ventilation amount is reduced and ventilation effect will be deteriorated. Clean the filter and heat-exchanger element regularly according to the extent of dust accumulation.

## ⚠ WARNING

Before performing maintenance, stop the unit, then turn off the breaker. Otherwise, an electric shock or injury may result.

## ⚠ CAUTION

Wear protective gloves when performing maintenance.  
• Otherwise, an injury may result.

## ■ Maintenance of the filter and heat-exchanger element

### ◆ Filter maintenance (Clean the filter once or twice a year.)

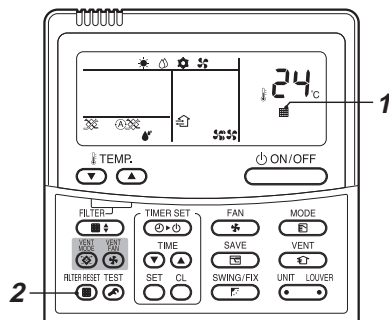

- 1 Clean the filter if is indicated on the remote controller.
- 2 Press the button after cleaning the filter. The indicator disappears.

### 1 Open the inspection cover.

Enter the ceiling cavity remove the screw of fixed part of inspection cover and remove the fixing lever (support the inspection cover while removing the lever), then open the inspection cover.

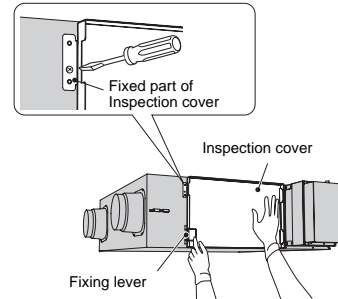

### 2 Pull out the heat exchanger elements.

Filters are attached to the heat exchanger element. Hold the handle of the heat exchanger element, then pull it out.

\* 2 heat exchanger elements are equipped with this unit.

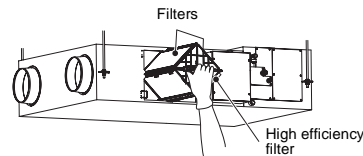

## ⚠ CAUTION

The table below shows the weight of each heat exchanger element. Handle the heat exchanger element carefully so as not to drop it.

Model name	Weight (kg/unit)	Quantity
MMD-VNK502HEXE MMD-VN502HEXE	2.9	2
MMD-VNK802HEXE MMD-VN802HEXE	4.0	2
MMD-VNK1002HEXE MMD-VN1002HEXE	4.0	2
MMD-VNK1002HEXE2 MMD-VN1002HEXE2	4.0	2

### 3 Remove the filters.

Remove the filters from the frame of the heat exchanger element.

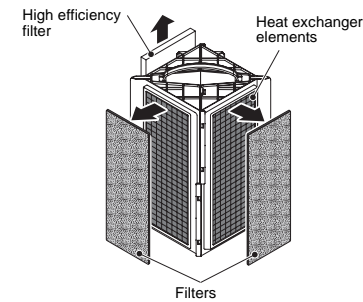

### 4 Clean the filters.

Clean the filters by dusting them or using a vacuum cleaner. If the filters are badly clogged, wash them by pressing them down in lukewarm water with a neutral dish washing liquid.

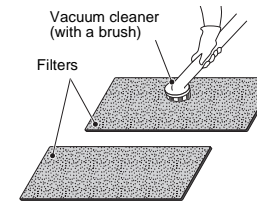

### 5 Clean the high efficiency filters clean the filters by using a vacuum cleaner.

High efficiency filters cannot be reused. Change them at 2500 hours of use.

## NOTE

- Do not dry the filter with heat from a flame; otherwise, deformation or deterioration of the filter may result.
- Light-up hours of the indicator is set to [2500 H]. If the filter is badly clogged, change the setting value.
- Do not soak the filter in water hotter than 60 °C; otherwise, deformation or deterioration of the filter may result.

## ■ Maintenance of the heat exchanger elements (Clean the heat exchanger elements once or twice in 2 years.)

### 1 Clean the heat exchanger elements

Remove the dust on the surface of the heat exchanger element using a vacuum cleaner.

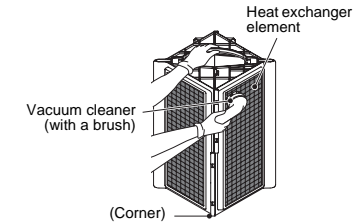

Do not wash in water

## NOTE

- Use a vacuum cleaner with a brush, and stroke the brush gently on the heat exchanger element.
- Do not press the nozzle of the vacuum cleaner hard against the heat exchanger element; otherwise, the surface of it will be scratched.
- Do not wash the heat exchanger element in water.

## ■ Reinstallation after maintenance

### 1 Attach the filters and High efficiency filters.

Attach the filters after they have completely dried. Attach them to the frame of the heat exchanger element as before.

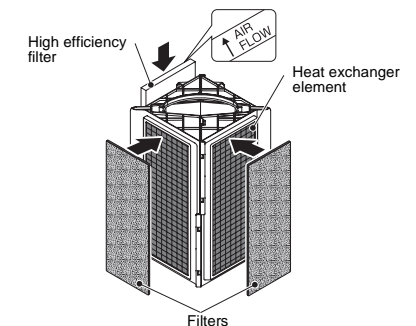

## 2 Attach the heat exchanger elements.

Install the heat exchanger elements as before.

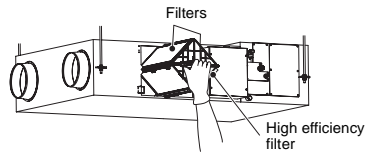

### NOTE

Attach the filters. If you use this unit without them, the heat exchanger elements will become clogged and a breakdown may result.

## 3 Attach the inspection cover.

Fit the fixing lever to the inspection cover to attach it securely and fix the fixed part of Inspection cover with a screw.

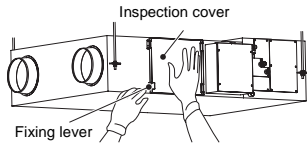

## ■ Cleaning remote controller

- Wipe with a dry, soft cloth.
- Do not use benzine, thinner, scouring powder, chemical cloth, etc. as those may cause deformation or breakage.



## ■ Maintenance and safety checks (for installers)

Ask the dealer to carry out the following safety checks once a year for your continued use of our product.

- Turn off the circuit breaker in the power distribution panel before starting safety checks.
- Do not use any detergent or the like when cleaning the humidifier. (VNK type only)

Parts to check	Safety checks	Actions	Possible failures
	Items to be checked		
Strainer (VNK type only)	Clogging with dust Damage of the O-ring	Clean the strainer if it is clogged. Replace the ring if it is damaged.	No humidification Water leakage
Humidification element (VNK type only)	Water leakage from the surface of humidification element	Replace the humidification element if water squirts out of the surface of element.*	Water leakage
	Dust and dirt on the surface of humidification element	Vacuum the element if the air way is blocked with dust. (Take care not to damage the surface of element.) or, wash the element with water according to the instructions on page 25.	Reduced fan power Reduced humidification performance
Drain pan	Dust and dirt on the surface of drain pan	Clean with a cloth if there is dust and dirt on the drain pan.	Water leakage

\* A small amount of water may come out because of condensation. This is not unusual.

## ◆ Preparation for cleaning

- 1 Close the service valve. (VNK type only)**  
(For preventing water remaining inside from spattering)
- 2 Prepare for water leakage. (VNK type only)**  
Water inside the humidification element will spill out. Take measures for water leakage, such as laying a plastic sheet.
- 3 Drain water remaining in the pipes. (VNK type only)**  
Open the drain valve and catch water using a bucket or the like.

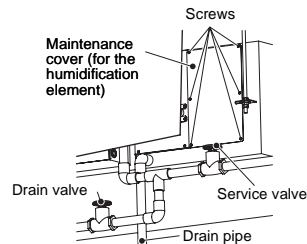

## 4 Detach the maintenance cover (for the humidification element)

Loosen the six screws that fasten the maintenance cover, then detach it.

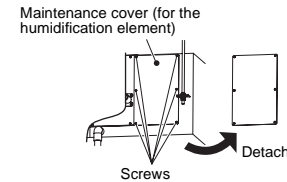

## ◆ Cleaning the strainer (filter) (VNK type only)

- 1 Pull the heat insulator of strainer and turn it upward.**

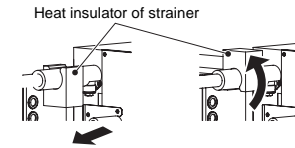

- 2 Turn the strainer cap counterclockwise to detach.**
- 3 Clean the filter with water.**
- 4 Re-attach the strainer cap.**

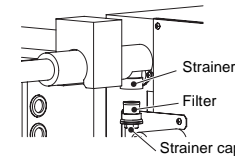

## ◆ Detaching the humidification element (VNK type only)

### Remove the spacer

- 1 Pull out the spacer by taking the hold.**

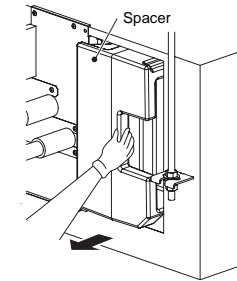

### Detach the water supply tube from the humidification element

- 1 Pinch the tabs of the hose band of the water supply tube attached to the front humidification element to displace, then detach the water supply tube.**

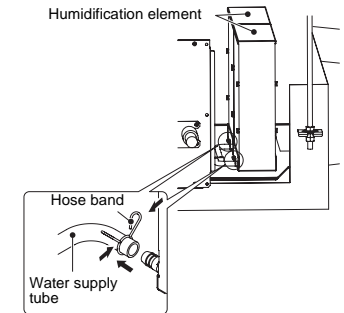

### NOTE

- Do not detach the water supply tube from the reducing valve.
- Detach the water supply tube and point it toward the drain pan inside the unit so that water falls into the drain pan.

**Detach the humidification element (VNK type only)**

- 1 Pull the front humidification element to detach.
- 2 (MMD-VNK802 / MMD-VNK1002) Pinch the tabs of the hose band of the water supply tube attached to the back humidification element, then detach the tube.
- 3 (MMD-VNK802 / MMD-VNK1002) Pull the back humidification element to detach.

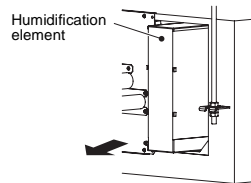
**NOTE**

- Drain water remaining in the humidification element into the drain pan.
- Do not bend, fold, or pull the water supply tube.

Model name	Quantity of the humidification element
MMD-VNK502HEXE	1
MMD-VNK802HEXE	2
MMD-VNK1002HEXE MMD-VNK1002HEXE2	2

**Washing the humidification element (VNK type only)**

Wash away dust and dirt from the humidification element by putting the element in a bucket of water. Move the element in the bucket up and down to wash.

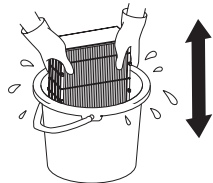
**NOTE**

- Do not use a scrubbing brush.
- Do not water the humidification element with a hose; otherwise, the element may be damaged.
- Do not use hot water of 40 °C or hotter. Do not use any detergent.

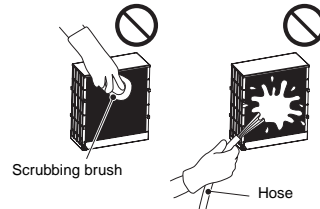
**Attaching the humidification element (VNK type only)**

- Attach the humidification element in the reverse order to detach it.
- Attach the water supply tube securely and ensure that there is no water leakage.

**Cleaning the drain pan (All type)**

Check whether there is dust and dirt in the drain pan and drain outlet. Clean up the drain pan and drain outlet when they are clogged.

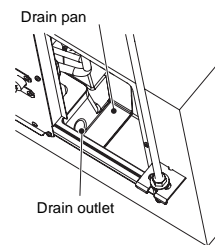
**Checking after servicing (VNK type only)**

- 1 Open the service valve as necessary.
- 2 In winter (the season for using the humidifier), check whether the antifreeze heater is turned on.
- 3 Perform a test run and ensure that there is no water leakage.

**NOTE**

When the humidifier is not used, drain off water from the cistern tank and water supply pipe.

**Maintenance of the humidifier element (VNK type only)**

The replacement cycle of the humidifier element varies greatly depending on the conditions of use. Refer to the cycles below as general replacement cycles. (They are not the terms of guarantee.)

When the water hardness is 25 mg/L	Every 5 years
When the water hardness is 50 mg/L	Every 3 years
When the water hardness is 100 mg/L	Every 2 years

- The humidifying performance deteriorates gradually as impurities in tap water are accumulated in the humidifying element.
- In general, replace the humidifying element when the humidifying performance of the element has deteriorated by 20 to 40 % compared with that of a new one.
- Estimated operating hours: 10 hours per day X 20 days per month X 5 months per year = 1000 hours per year
- The amount of impurities accumulated in the humidifying element is largely dependent on the water quality (water hardness, the variety or amount of impurities, the pH of the water, water temperature, etc.) or conditions of use.

# 17 Troubleshooting

## Confirmation and check

When an error occurred in the Air to Air Heat Exchanger with DX Coil Unit, the check code and the indoor unit No. appear on the display part of the remote controller.

The check code is only displayed during the operation. If the display disappears, operate the Air to Air Heat Exchanger with DX Coil Unit according to the following "Confirmation of error log" for confirmation.

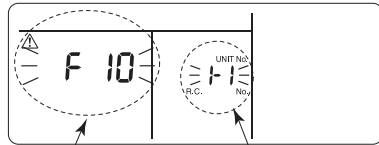

Check code Unit No. of the Air to Air Heat Exchanger with DX Coil Unit with a problem

## Confirmation of error log

When an error occurred on the Air to Air Heat Exchanger with DX Coil Unit, the error log can be confirmed with the following procedure. (The error log is stored in memory up to 4 errors.)

The log can be confirmed from both operating status and stop status.

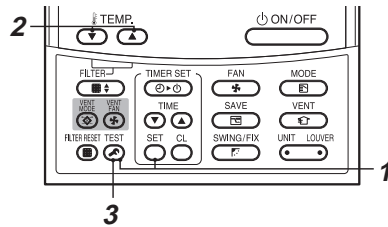

### 1 When **SET** and **TEST** buttons are pushed simultaneously for 4 seconds or more, the following display appears.

If [Service check] is displayed, the mode enters in the error log mode.

- [01: Order of error log] is displayed in CODE No. window.
- [Check code] is displayed in CHECK window.
- [Air to Air Heat Exchanger with DX Coil Unit address in which an error occurred] is displayed in Unit No.

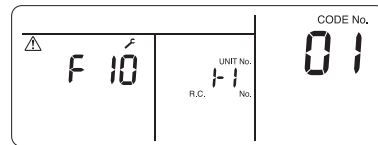

### 2 Every pushing of **TEMP.** button used to set temperature, the error log stored in memory is displayed in order.

The numbers in CODE No. indicate CODE No. [01] (latest) → [04] (oldest).

#### REQUIREMENT

Do not push button because all the error log of the Air to Air Heat Exchanger with DX Coil Unit will be deleted.

### 3 After confirmation, push **TEST** button to return to the usual display.

## How to check

To display an error code or to confirm the operation status, the remote controller (wired remote controller and central remote controller) is equipped with an LCD display, and the interface circuit board of the outdoor unit is equipped with a 7 segment display. A self-diagnosis function is activated to find out the details of a problem with the unit.

## Error code list

The table below shows the error codes. See the table for details of error codes.

- To confirm the code from the remote controller, see "Wired remote controller display" in the table.
- To confirm the code from the outdoor unit, see "7 segment display on the outdoor unit" in the table.

Wired remote controller display	Check code		Check code name	Judging device
	7 segment display on the outdoor unit	Auxiliary code		
E01	—	—	Indoor unit - remote controller communication error (Detected by remote controller)	Remote controller
E02	—	—	Remote control transmission error	Remote controller
E03	—	—	Indoor unit - remote controller communication error (Detected by indoor unit)	Indoor
E04	—	—	Indoor / Outdoor unit communication circuit error (Detected by indoor unit)	Indoor
E06	E06	Number of indoor units for normal reception	Number of indoor units decreasing	I/F
—	E07	—	Indoor / Outdoor unit communication circuit error (Detected by outdoor unit)	I/F
E08	E08	Duplicate indoor addresses	Duplicate indoor addresses	Indoor I/F
E09	—	—	Duplicate header remote controllers	Remote controller
E10	—	—	Indoor MCU communication error	Indoor
E12	E12	01: Indoor / Outdoor unit communication 02: Communications between outdoor units	Automatic address start error	I/F
E15	E15	—	No indoor unit during automatic address	I/F
E16	E16	00: Over capacity 01 ~: Number of connected units	Number of connected units / Over capacity	I/F
E18	—	—	Indoor header - follower communication error	Indoor
E19	E19	00: No center unit 02: Multiple center units	Unusual number of center outdoor units	I/F
E20	E20	01: Outdoor connections of another line 02: Indoor connections of another line	Connections of another line during automatic address	I/F
E21	E21	02: No header unit 00: Number of duplicate header units	Unusual number of thermal header units	I/F
E22	E22	—	Number of thermal units decreasing	I/F
E23	E23	—	Transmission error between outdoor units Number of thermal units error (Reception error)	I/F
E25	E25	—	Duplicate terminal outdoor address settings	I/F
E26	E26	Number of outdoor units for normal reception	Number of connected outdoor units decreasing	I/F
E28	E28	Detected outdoor unit No.	Terminal outdoor error	I/F

Wired remote controller display	Check code				Check code name	Judging device		
	7 segment display on the outdoor unit							
	Auxiliary code							
E31	E31	A3-IPDU			Fan IPDU	IPDU communication error	I/F	
		1	2	3				
		01	○					
		02		○				
		03	○	○				
		04			○			
		05	○		○			
		06		○	○			
		07	○	○	○			
		08						○
		09	○					○
		0A		○				○
		0B	○	○				○
		0C			○			○
		0D	○		○			○
		0E		○	○			○
		0F	○	○	○			○
○: IPDU error								
F01	—	—	—	Indoor TCJ sensor error	Indoor			
F02	—	—	—	Indoor TC2 sensor error	Indoor			
F03	—	—	—	Indoor TC1 sensor error	Indoor			
F04	F04	—	—	TD1 sensor error	I/F			
F05	F05	—	—	TD2 sensor error	I/F			
F06	F06	01: TE1 02: TE2	—	TE1 sensor error	I/F			
F07	F07	01: TE1 02: TE2	—	TL sensor error	I/F			
F08	F08	—	—	TO sensor error	I/F			
F10	F10	—	—	Indoor TSA sensor error	Indoor			
F11	—	—	—	Indoor TFA sensor error	Indoor			
F12	F12	—	—	TS1 sensor error	I/F			
F13	F13	01: Compressor 1 02: Compressor 2 03: Compressor 3	—	TH sensor error	IPDU			
F15	F15	—	—	Miswiring of outdoor temperature sensor (TE, TL) error	I/F			
F16	F16	—	—	Miswiring of outdoor pressure sensor (Pd, Ps)	I/F			
F17	—	—	—	Indoor TOA sensor error	Indoor			
F18	—	—	—	Indoor TRA sensor error	Indoor			
F22	F22	—	—	TD3 sensor error	I/F			
F23	F23	—	—	Ps sensor error	I/F			
F24	F24	—	—	Pd sensor error	I/F			
F29	—	—	—	Indoor unit or other error	Indoor			
F31	F31	—	—	Outdoor EEPROM error	I/F			
H01	H01	01: Compressor 1 02: Compressor 2 03: Compressor 3	—	Compressor breakdown	IPDU			
H02	H02	01: Compressor 1 02: Compressor 2 03: Compressor 3	—	Compressor error (Lock)	IPDU			
H03	H03	01: Compressor 1 02: Compressor 2 03: Compressor 3	—	Current detection circuit error	IPDU			
H05	H05	—	—	Miswiring of outdoor discharge temperature sensor (TD1)	I/F			
H06	H06	—	—	Low-pressure protection activation	I/F			
H07	H07	—	—	Lower oil level detection protection	I/F			

Wired remote controller display	Check code				Check code name	Judging device		
	7 segment display on the outdoor unit							
	Auxiliary code							
H08	H08	01: TK1 sensor error 02: TK2 sensor error 03: TK3 sensor error 04: TK4 sensor error 05: TK5 sensor error		Oil level detection temperature sensor error	I/F			
H15	H15	—		Miswiring of outdoor discharge temperature sensor (TD2)	I/F			
H16	H16	01: TK1 oil circuit error 02: TK2 oil circuit error 03: TK3 oil circuit error 04: TK4 oil circuit error 05: TK5 oil circuit error		Oil detection circuit error	I/F			
H25	H25	—		Miswiring of outdoor discharge temperature sensor (TD3)	I/F			
L02	—	—		Outdoor unit model mismatch error	Indoor			
L03	—	—		Duplicate header indoor units	Indoor			
L04	L04	—		Duplicate outdoor line addresses	I/F			
L05	—	—		Duplicate prior indoor (Displayed for prior indoor)	I/F			
L06	L06	Number of prior indoor units		Duplicate prior indoor (Displayed for non-prior indoor)	I/F			
L07	—	—		Group line in an individual indoor unit	Indoor			
L08	L08	—		Indoor group address not set	Indoor I/F			
L09	—	—		Indoor capacity not set	Indoor			
L10	L10	—		Outdoor capacity not set	I/F			
L20	—	—		Duplicate central control addresses	AINET indoor			
L26	L26	Number of connected thermal units		Number of connected thermal units exceeded	I/F			
L27	L27	Number of connected thermal units		Number of connected thermal units error	I/F			
L28	L28	—		Number of connected outdoor units exceeded	I/F			
L29	L29	A3-IPDU			Fan IPDU	IPDU communication error	I/F	
		1	2	3				
		01	○					
		02		○				
		03	○	○				
		04			○			
		05	○		○			
		06		○	○			
		07	○	○	○			
		08						○
		09	○					○
		0A		○				○
		0B	○	○				○
		0C			○			○
		0D	○		○			○
		0E		○	○			○
		0F	○	○	○			○
○: IPDU error								
L30	L30	Detect indoor addresses		External interlock for indoor unit	Indoor			
—	L31	—		Expanded I/C error	I/F			
P03	P03	—		Discharge temperature TD1 error	I/F			
P04	P04	01: Compressor 1 02: Compressor 2 03: Compressor 3		High-pressure SW activation	IPDU			
P05	P05	01: Open phase detected 02: Phase sequence error		Open phase detected, Phase sequence error	I/F			

Wired remote controller display	Check code		Check code name	Judging device
	7 segment display on the outdoor unit			
	Auxiliary code			
P07	P07	01: Compressor 1 02: Compressor 2 03: Compressor 3	Heat sink overheat error	IPDU I/F
P09	P09	Detect thermal addresses	Thermal unit water shortage error	Thermal
P10	P10	Detect indoor addresses	Indoor overflow error	Indoor
P13	P13	—	Outdoor compressor liquid compression error	I/F
P15	P15	01: TS condition 02: TD condition	Gas leak detection	I/F
P17	P17	—	Discharge temperature TD2 error	I/F
P19	P19	Detected outdoor unit No.	Four-way valve reverse error	I/F
P20	P20	—	High-pressure protection activation	I/F
P22	P22	0*: IGBT circuit 1*: Position detection circuit error 3*: Motor lock circuit 4*: Motor current detection C*: TH sensor error D*: TH sensor error E*: Inverter DC voltage error (Outdoor fan) Note: 0 – F appears in "*" above. Ignore it.	Outdoor fan IPDU error	IPDU
P26	P26	01: Compressor 1 02: Compressor 2 03: Compressor 3	G-TR short circuit protection error	IPDU
P29	P29	01: Compressor 1 02: Compressor 2 03: Compressor 3	Compressor position detection circuit error	IPDU
P31	—	—	Other indoor unit error (Follower unit error)	Indoor
—	—	—	Error in the indoor group	AINET
—	—	—	AINET communication error	AINET
—	—	—	Network adapter error	AINET

### ■ Errors detected by TCC-LINK central control device

Wired remote controller display	Check code		Check code name	Judging device
	7 segment display on the outdoor unit			
	Auxiliary code			
C05	—	—	Transmission errors of the TCC-LINK central control device	TCC-LINK line
C06	—	—	Reception errors of the TCC-LINK central control device	TCC-LINK line
C12	—	—	Simultaneous alarms for general-purpose device control interface	General-purpose device I/F
P30	Depends on the error content of the alarmed unit.		Follower unit error	TCC-LINK line
—	—	—	Duplicate central control addresses	

## Checking the settings of the indoor units

Before handing the system over to the customer, check the addresses and settings of the indoor units, then fill in the check sheet below. When you have installed a group control system, fill in the check sheet for each system and for each indoor unit. (You can enter the settings of 4 indoor units in to one check sheet.)

### NOTE

For maintenance after installation, fill in the check sheet and hand over this Installation manual to the customer.

### ■ Indoor unit settings check sheet

Indoor unit			Indoor unit			Indoor unit			Indoor unit		
Model name			Model name			Model name			Model name		
<b>Check the addresses of the indoor units. (For details, see "Advanced control" in this manual.)</b> (Code: [12] for the system, [13] for indoor units, and [14] for groups)											
Line	Indoor	Group	Line	Indoor	Group	Line	Indoor	Group	Line	Indoor	Group
Settings			Settings			Settings			Settings		
Did you change the setting for the lighting-up hours of the Filter Sign? If you did not, put a tick against "No change". If you did, put a tick against the item you selected. (For details, see "Advanced control" in this manual.)											
Lighting-up hours of the Filter Sign (Code: [01]) <input type="checkbox"/> No change <input type="checkbox"/> None [0000] <input type="checkbox"/> 150H [0001] <input type="checkbox"/> 2500H [0002] <input type="checkbox"/> 5000H [0003] <input type="checkbox"/> 10000H [0004]			Lighting-up hours of the Filter Sign (Code: [01]) <input type="checkbox"/> No change <input type="checkbox"/> None [0000] <input type="checkbox"/> 150H [0001] <input type="checkbox"/> 2500H [0002] <input type="checkbox"/> 5000H [0003] <input type="checkbox"/> 10000H [0004]			Lighting-up hours of the Filter Sign (Code: [01]) <input type="checkbox"/> No change <input type="checkbox"/> None [0000] <input type="checkbox"/> 150H [0001] <input type="checkbox"/> 2500H [0002] <input type="checkbox"/> 5000H [0003] <input type="checkbox"/> 10000H [0004]			Lighting-up hours of the Filter Sign (Code: [01]) <input type="checkbox"/> No change <input type="checkbox"/> None [0000] <input type="checkbox"/> 150H [0001] <input type="checkbox"/> 2500H [0002] <input type="checkbox"/> 5000H [0003] <input type="checkbox"/> 10000H [0004]		
Did you change the setting for the detect temperature shift value? If you did not, select the "No change" checkbox. If you did, select the checkbox of an item. (For details, see "Advanced Control" in this manual.)											
Detect temperature shift value (Code: [06]) <input type="checkbox"/> No change <input type="checkbox"/> No shift [0000] <input type="checkbox"/> + 1 °C [0001] <input type="checkbox"/> + 2 °C [0002] <input type="checkbox"/> + 3 °C [0003] <input type="checkbox"/> + 4 °C [0004] <input type="checkbox"/> + 5 °C [0005] <input type="checkbox"/> + 6 °C [0006]			Detect temperature shift value (Code: [06]) <input type="checkbox"/> No change <input type="checkbox"/> No shift [0000] <input type="checkbox"/> + 1 °C [0001] <input type="checkbox"/> + 2 °C [0002] <input type="checkbox"/> + 3 °C [0003] <input type="checkbox"/> + 4 °C [0004] <input type="checkbox"/> + 5 °C [0005] <input type="checkbox"/> + 6 °C [0006]			Detect temperature shift value (Code: [06]) <input type="checkbox"/> No change <input type="checkbox"/> No shift [0000] <input type="checkbox"/> + 1 °C [0001] <input type="checkbox"/> + 2 °C [0002] <input type="checkbox"/> + 3 °C [0003] <input type="checkbox"/> + 4 °C [0004] <input type="checkbox"/> + 5 °C [0005] <input type="checkbox"/> + 6 °C [0006]			Detect temperature shift value (Code: [06]) <input type="checkbox"/> No change <input type="checkbox"/> No shift [0000] <input type="checkbox"/> + 1 °C [0001] <input type="checkbox"/> + 2 °C [0002] <input type="checkbox"/> + 3 °C [0003] <input type="checkbox"/> + 4 °C [0004] <input type="checkbox"/> + 5 °C [0005] <input type="checkbox"/> + 6 °C [0006]		
Did you change the setting for the single operation of the Air to Air Heat Exchanger with direct expansion coil? If you did not, put a tick against "No change". If you did, put a tick against the item you selected. (For details, see "Advanced control" in this manual.)											
Single operation of the Air to Air Heat Exchanger with direct expansion coil (Code: [31]) <input type="checkbox"/> No change <input type="checkbox"/> No [0000] <input type="checkbox"/> Yes [0001]			Single operation of the Air to Air Heat Exchanger with direct expansion coil (Code: [31]) <input type="checkbox"/> No change <input type="checkbox"/> No [0000] <input type="checkbox"/> Yes [0001]			Single operation of the Air to Air Heat Exchanger with direct expansion coil (Code: [31]) <input type="checkbox"/> No change <input type="checkbox"/> No [0000] <input type="checkbox"/> Yes [0001]			Single operation of the Air to Air Heat Exchanger with direct expansion coil (Code: [31]) <input type="checkbox"/> No change <input type="checkbox"/> No [0000] <input type="checkbox"/> Yes [0001]		
Did you change the setting for the remote controller sensor? If you did not, select the "No change" checkbox. If you did, select the checkbox of an item. (For details, see "Advanced Control" in this manual.)											
Remote controller sensor (Code: [32]) <input type="checkbox"/> No change <input type="checkbox"/> Do not use [0000] <input type="checkbox"/> Use [0001]			Remote controller sensor (Code: [32]) <input type="checkbox"/> No change <input type="checkbox"/> Do not use [0000] <input type="checkbox"/> Use [0001]			Remote controller sensor (Code: [32]) <input type="checkbox"/> No change <input type="checkbox"/> Do not use [0000] <input type="checkbox"/> Use [0001]			Remote controller sensor (Code: [32]) <input type="checkbox"/> No change <input type="checkbox"/> Do not use [0000] <input type="checkbox"/> Use [0001]		

Indoor unit			Indoor unit			Indoor unit			Indoor unit		
Model name			Model name			Model name			Model name		
<p>Check the addresses of the indoor units. (For details, see "Advanced control" in this manual.) (Code: [12] for the system, [13] for indoor units, and [14] for groups)</p>											
Line	Indoor	Group	Line	Indoor	Group	Line	Indoor	Group	Line	Indoor	Group
Settings			Settings			Settings			Settings		
<p>Did you change the setting for the imbalance ventilation operation? If you did not, put a tick against "No change". If you did, put a tick against the item you selected. (For details, see "Advanced control" in this manual.)</p>											
Imbalance ventilation operation (Code: [48]) <input type="checkbox"/> No change <input type="checkbox"/> Normal [0000] <input type="checkbox"/> SA (High) > EA (Low) active [0001] <input type="checkbox"/> SA (Low) < EA (High) active [0002] * "High" may be "Extra High".			Imbalance ventilation operation (Code: [48]) <input type="checkbox"/> No change <input type="checkbox"/> Normal [0000] <input type="checkbox"/> SA (High) > EA (Low) active [0001] <input type="checkbox"/> SA (Low) < EA (High) active [0002] * "High" may be "Extra High".			Imbalance ventilation operation (Code: [48]) <input type="checkbox"/> No change <input type="checkbox"/> Normal [0000] <input type="checkbox"/> SA (High) > EA (Low) active [0001] <input type="checkbox"/> SA (Low) < EA (High) active [0002] * "High" may be "Extra High".			Imbalance ventilation operation (Code: [48]) <input type="checkbox"/> No change <input type="checkbox"/> Normal [0000] <input type="checkbox"/> SA (High) > EA (Low) active [0001] <input type="checkbox"/> SA (Low) < EA (High) active [0002] * "High" may be "Extra High".		
<p>Did you change the setting for the nighttime heat purge operation? If you did not, put a tick against "No change". If you did, put a tick against the item you selected. (For details, see "Advanced control" in this manual.)</p>											
Nighttime heat purge operation (Code: [4C]) <input type="checkbox"/> No change <input type="checkbox"/> Nighttime heat purge OFF [0000] <input type="checkbox"/> Start after the setting value x 1 hour(s) [0001]-[0048]			Nighttime heat purge operation (Code: [4C]) <input type="checkbox"/> No change <input type="checkbox"/> Nighttime heat purge OFF [0000] <input type="checkbox"/> Start after the setting value x 1 hour(s) [0001]-[0048]			Nighttime heat purge operation (Code: [4C]) <input type="checkbox"/> No change <input type="checkbox"/> Nighttime heat purge OFF [0000] <input type="checkbox"/> Start after the setting value x 1 hour(s) [0001]-[0048]			Nighttime heat purge operation (Code: [4C]) <input type="checkbox"/> No change <input type="checkbox"/> Nighttime heat purge OFF [0000] <input type="checkbox"/> Start after the setting value x 1 hour(s) [0001]-[0048]		
<p>Did you change the setting for the linked operation with external devices? If you did not, put a tick against "No change". If you did, put a tick against the item you selected. (For details, see "Advanced control" in this manual.)</p>											
Setting of the linked operation with external devices (Code: [4E]) <input type="checkbox"/> No change <input type="checkbox"/> ON/OFF linked [0000] <input type="checkbox"/> ON linked [0001] <input type="checkbox"/> OFF linked [0002]			Setting of the linked operation with external devices (Code: [4E]) <input type="checkbox"/> No change <input type="checkbox"/> ON/OFF linked [0000] <input type="checkbox"/> ON linked [0001] <input type="checkbox"/> OFF linked [0002]			Setting of the linked operation with external devices (Code: [4E]) <input type="checkbox"/> No change <input type="checkbox"/> ON/OFF linked [0000] <input type="checkbox"/> ON linked [0001] <input type="checkbox"/> OFF linked [0002]			Setting of the linked operation with external devices (Code: [4E]) <input type="checkbox"/> No change <input type="checkbox"/> ON/OFF linked [0000] <input type="checkbox"/> ON linked [0001] <input type="checkbox"/> OFF linked [0002]		
<p>Did you change the setting for changing the ventilation mode? If you did not, put a tick against "No change". If you did, put a tick against the item you selected. (For details, see "Advanced control" in this manual.)</p>											
Changing the ventilation mode (Code: [EA]) <input type="checkbox"/> No change <input type="checkbox"/> Heat exchange mode [0002] <input type="checkbox"/> Automatic mode [0003] Compatible with RBC-AMT32E			Changing the ventilation mode (Code: [EA]) <input type="checkbox"/> No change <input type="checkbox"/> Heat exchange mode [0002] <input type="checkbox"/> Automatic mode [0003] Compatible with RBC-AMT32E			Changing the ventilation mode (Code: [EA]) <input type="checkbox"/> No change <input type="checkbox"/> Heat exchange mode [0002] <input type="checkbox"/> Automatic mode [0003] Compatible with RBC-AMT32E			Changing the ventilation mode (Code: [EA]) <input type="checkbox"/> No change <input type="checkbox"/> Heat exchange mode [0002] <input type="checkbox"/> Automatic mode [0003] Compatible with RBC-AMT32E		

Indoor unit			Indoor unit			Indoor unit			Indoor unit		
Model name			Model name			Model name			Model name		
<p>Check the addresses of the indoor units. (For details, see "Advanced control" in this manual.) (Code: [12] for the system, [13] for indoor units, and [14] for groups)</p>											
Line	Indoor	Group	Line	Indoor	Group	Line	Indoor	Group	Line	Indoor	Group
Settings			Settings			Settings			Settings		
<p>Did you change the setting for changing the ventilation FAN speed? If you did not, put a tick against "No change". If you did, put a tick against the item you selected. (For details, see "Advanced control" in this manual.)</p>											
Changing the ventilation FAN speed (Code: [EB]) <input type="checkbox"/> No change <input type="checkbox"/> High [0002] <input type="checkbox"/> Low [0003] <input type="checkbox"/> Imbalance [0004] * "High" may be "Extra High". Compatible with RBC-AMT32E			Changing the ventilation FAN speed (Code: [EB]) <input type="checkbox"/> No change <input type="checkbox"/> High [0002] <input type="checkbox"/> Low [0003] <input type="checkbox"/> Imbalance [0004] * "High" may be "Extra High". Compatible with RBC-AMT32E			Changing the ventilation FAN speed (Code: [EB]) <input type="checkbox"/> No change <input type="checkbox"/> High [0002] <input type="checkbox"/> Low [0003] <input type="checkbox"/> Imbalance [0004] * "High" may be "Extra High". Compatible with RBC-AMT32E			Changing the ventilation FAN speed (Code: [EB]) <input type="checkbox"/> No change <input type="checkbox"/> High [0002] <input type="checkbox"/> Low [0003] <input type="checkbox"/> Imbalance [0004] * "High" may be "Extra High". Compatible with RBC-AMT32E		
<p>Did you change the setting for changing the operation output? If you did not, put a tick against "No change". If you did, put a tick against the item you selected. (For details, see "Advanced control" in this manual.)</p>											
Changing the operation output (Code: [ED]) <input type="checkbox"/> No change <input type="checkbox"/> ON during normal operation [0000] <input type="checkbox"/> ON during normal operation or the nighttime heat purge operation [0001] <input type="checkbox"/> ON during the nighttime heat purge operation [0002] <input type="checkbox"/> ON when the SA fan is running [0003] <input type="checkbox"/> ON when the EA fan is running [0004]			Changing the operation output (Code: [ED]) <input type="checkbox"/> No change <input type="checkbox"/> ON during normal operation [0000] <input type="checkbox"/> ON during normal operation or the nighttime heat purge operation [0001] <input type="checkbox"/> ON during the nighttime heat purge operation [0002] <input type="checkbox"/> ON when the SA fan is running [0003] <input type="checkbox"/> ON when the EA fan is running [0004]			Changing the operation output (Code: [ED]) <input type="checkbox"/> No change <input type="checkbox"/> ON during normal operation [0000] <input type="checkbox"/> ON during normal operation or the nighttime heat purge operation [0001] <input type="checkbox"/> ON during the nighttime heat purge operation [0002] <input type="checkbox"/> ON when the SA fan is running [0003] <input type="checkbox"/> ON when the EA fan is running [0004]			Changing the operation output (Code: [ED]) <input type="checkbox"/> No change <input type="checkbox"/> ON during normal operation [0000] <input type="checkbox"/> ON during normal operation or the nighttime heat purge operation [0001] <input type="checkbox"/> ON during the nighttime heat purge operation [0002] <input type="checkbox"/> ON when the SA fan is running [0003] <input type="checkbox"/> ON when the EA fan is running [0004]		
<p>Did you change the setting for changing the abnormal signal / bypass ventilation signal output? If you did not, put a tick against "No change". If you did, put a tick against the item you selected. (For details, see "Advanced control" in this manual.)</p>											
Changing the abnormal signal / bypass ventilation signal output (Code: [EE]) <input type="checkbox"/> No change <input type="checkbox"/> ON when an abnormal signal is detected [0000] <input type="checkbox"/> ON when the bypass ventilation signal is detected [0001]			Changing the abnormal signal / bypass ventilation signal output (Code: [EE]) <input type="checkbox"/> No change <input type="checkbox"/> ON when an abnormal signal is detected [0000] <input type="checkbox"/> ON when the bypass ventilation signal is detected [0001]			Changing the abnormal signal / bypass ventilation signal output (Code: [EE]) <input type="checkbox"/> No change <input type="checkbox"/> ON when an abnormal signal is detected [0000] <input type="checkbox"/> ON when the bypass ventilation signal is detected [0001]			Changing the abnormal signal / bypass ventilation signal output (Code: [EE]) <input type="checkbox"/> No change <input type="checkbox"/> ON when an abnormal signal is detected [0000] <input type="checkbox"/> ON when the bypass ventilation signal is detected [0001]		



# WARNINGS ON REFRIGERANT LEAKAGE

## Check of Concentration Limit

The room in which the air conditioner is to be installed requires a design that in the event of refrigerant gas leaking out, its concentration will not exceed a set limit.

The refrigerant R410A which is used in the air conditioner is safe, without the toxicity or combustibility of ammonia, and is not restricted by laws to be imposed which protect the ozone layer. However, since it contains more than air, it poses the risk of suffocation if its concentration should rise excessively. Suffocation from leakage of R410A is almost non-existent.

With the recent increase in the number of high concentration buildings, however, the installation of multi air conditioner systems is on the increase because of the need for effective use of floor space, individual control, energy conservation by curtailing heat and carrying power etc.

Most importantly, the multi air conditioner system is able to replenish a large amount of refrigerant compared with conventional individual air conditioners. If a single unit of the multi conditioner system is to be installed in a small room, select a suitable model and installation procedure so that if the refrigerant accidentally leaks out, its concentration does not reach the limit (and in the event of an emergency, measures can be made before injury can occur).

In a room where the concentration may exceed the limit, create an opening with adjacent rooms, or install mechanical ventilation combined with a gas leak detection device.

The concentration is as given below.

$$\frac{\text{Total amount of refrigerant (kg)}}{\text{Min. volume of the indoor unit installed room (m}^3\text{)}} \leq \text{Concentration limit (kg/m}^3\text{)}$$

The concentration limit of R410A which is used in multi air conditioners is 0.3kg/m<sup>3</sup>.

### NOTE 1 :

If there are 2 or more refrigerating systems in a single refrigerating device, the amounts of refrigerant should be as charged in each independent device.

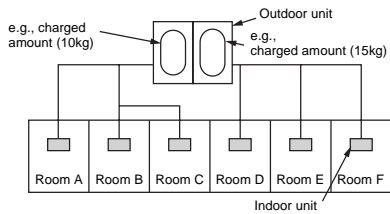

For the amount of charge in this example:

The possible amount of leaked refrigerant gas in rooms A, B and C is 10kg.

The possible amount of leaked refrigerant gas in rooms D, E and F is 15kg.

## Important

### NOTE 2 :

The standards for minimum room volume are as follows.

- (1) No partition (shaded portion)

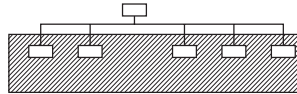

- (2) When there is an effective opening with the adjacent room for ventilation of leaking refrigerant gas (opening without a door, or an opening 0.15% or larger than the respective floor spaces at the top or bottom of the door).

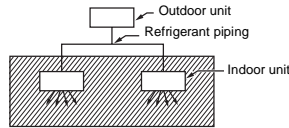

- (3) If an indoor unit is installed in each partitioned room and the refrigerant piping is interconnected, the smallest room of course becomes the object. But when a mechanical ventilation is installed interlocked with a gas leakage detector in the smallest room where the density limit is exceeded, the volume of the next smallest room becomes the object.

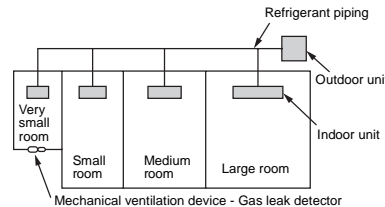

### NOTE 3 :

The minimum indoor floor area compared with the amount of refrigerant is roughly as follows:

(When the ceiling is 2.7m high)

