

**TOSHIBA**

—  
EXPERIENCE  
**THE FUTURE**  
—



QUALITY RELIABILITY ENVIRONMENT PROFITABILITY SIMPLICITY

---

EXPERIENCE  
**THE FUTURE**

---



QUALITY RELIABILITY ENVIRONMENT PROFITABILITY SIMPLICITY QU

- Every field has its own requirements and specifics directly related to its business and the space it occupies, be it residential, shops, offices or hotels.

Toshiba reinvigorates spaces, creates comfortable environments and encourages productivity.

Whatever your field, Toshiba is here to increase your business' performance.

# TOSHIBA BUSINESS SOLUTIONS

## Mini SMMS-e, SMMS-e, SMMS-u, SHRM-e

### > CREATING BENEFITS AROUND COMFORT

#### Benefits for the consultant



SMMS-u offers unlimited possibilities in terms of capacity, connectivity, indoor unit lineup and control solutions, providing the correct solution for your customers needs. Toshiba's intuitive selection tool will guide you through the selection process with minimal input from your side, ensuring trouble-free installation and operation.

All SMMS-u systems come with the Eurovent certification as standard.

#### Benefits for the user



There is nothing like a comfortable place to enjoy the present moment. Full of Toshiba innovations, the new SMMS-u guarantees all year round comfort combined with superior energy management, advanced air filtration and full control solutions for maximized product usability.

#### Benefits for the installer



Designed to perform and engineered to perfection, SMMS-u excels in managing the heating, cooling, hot water and fresh air input into offices, shops, restaurants and domestic housing, with unrivalled connection flexibility. You can rely on Toshiba support, to assist you from the project phase to commissioning and troubleshooting.

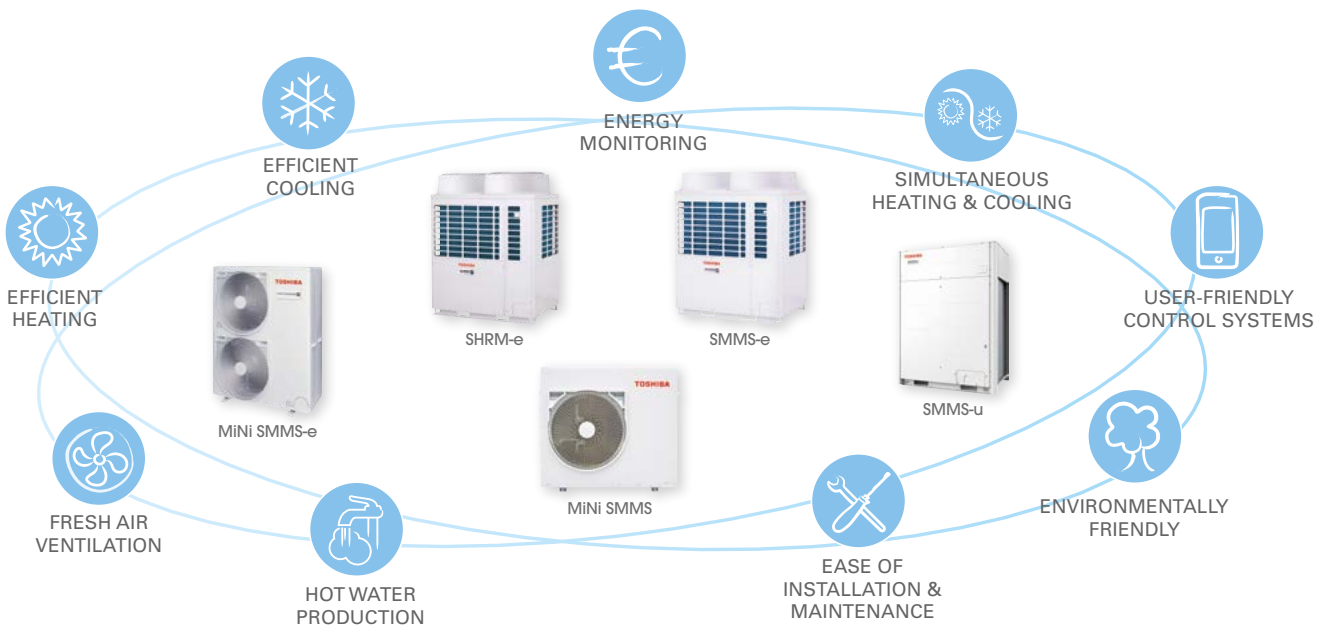

# ECODESIGN EUROPEAN DIRECTIVE



Lot 21: Heat pumps above 12 kW including residential, light commercial systems and VRF >>> DI, SDI, Big DI, MiNi SMMS-e, SMMS-e, SHRM-e, SMMS-u.

**ECODESIGN**

In the European Union, the Ecodesign Directive encourages HVAC manufacturers to design products taking into consideration their environmental impact throughout entire lifecycle. It establishes a framework for the setting of mandatory energy efficiency requirements for all energy-related products (ERPs).

For more information visit: [www.ecodesign.toshiba-airconditioning.eu](http://www.ecodesign.toshiba-airconditioning.eu)

## DESIGNED FOR THE FUTURE

Toshiba Air Conditioning is committed to designing products and solutions with increasingly lower environmental impacts. This subsequently reducing indirect CO<sub>2</sub> emissions generated by electricity consumption. Toshiba Air Conditioning's long-standing commitment to sustainable development is ahead of

schedule for the European climate and energy package requirements for 2030.

All Toshiba Air Conditioning products sold today in Europe are fully compliant with the latest Ecodesign directives.

## NEW ENERGY EFFICIENCY METRIC SEASONAL EFFICIENCY ( $\eta_{S,C}$ AND $\eta_{S,H}$ )

The Seasonal Coefficient of Performance, is a new European parameter to rate heat pumps in terms of energy efficiency. It is an update to the Coefficient of Performance, which previously recorded the power consumed to power produced ratio in heating and cooling modes for one operating point.

Unlike the EER/COP, the  $\eta_{SC}$  /  $\eta_{SH}$  take into account performances during cooler seasons because it considers temperature variations by including numerous realistic measurement points. When combined, this results in a more accurate energy classification.

### $\eta_{S,C}/\eta_{S,H}$ compared to EER/COP

TEMPERATURE (C°)	CAPACITY (KW)	AUXILIARY MODES (KWH)	HOURS
 <b>EER COP</b> One temperature requirement	 <b>EER COP</b> Full load	 <b>EER COP</b> Auxiliary power modes are not considered	 <b>EER COP</b> N/A
<b><math>\eta_{S,C}</math> <math>\eta_{S,H}</math></b> Numerous rating temperatures (range of average temperatures)	<b><math>\eta_{S,C}</math> <math>\eta_{S,H}</math></b> Partial load + Full load	<b><math>\eta_{S,C}</math> <math>\eta_{S,H}</math></b> Incl. consumption auxiliary modes: - Standby mode - Off mode - Thermostat off, etc.	<b><math>\eta_{S,C}</math> <math>\eta_{S,H}</math></b> Number of hours at each air temperature (in hours)

### SEASONAL COEFFICIENT OF PERFORMANCE CALCULATION

This is the ratio between annual heating/cooling demand and annual energy input over an entire heating/cooling season.

$$\eta_{S,H} = \frac{\text{ANNUAL HEATING DEMAND}}{\text{ANNUAL ENERGY INPUT}}$$

$$\eta_{S,C} = \frac{\text{ANNUAL COOLING DEMAND}}{\text{ANNUAL ENERGY INPUT}}$$

$$\eta_{S} = 100 \times \frac{\text{SEER or SCOP}}{2,5} - 3\%$$

# RELIABLE, EFFICIENT AND FLEXIBLE SMMS-u



## PERFECT COMBINATION OF EFFICIENCY AND FLEXIBILITY

### Innovative compressor technology

Toshiba rotary compressor technology brings outstanding performances to all SMMS systems with no compromise on system reliability.



- Large capacity
- Less refrigerant needed
- Low noise
- Wide operating range
- Low vibration
- DLC treatment

To maximize efficiency, Toshiba Inverter control can adjust the compressor rotational speed in a near seamless 0.1 Hz steps.

### Top class efficiency

Utilizing the highly efficient core technologies results in greater energy efficiency and performances.

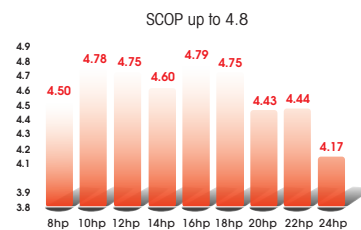
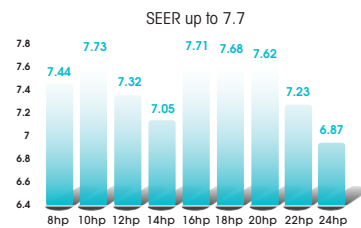

### Strong adaptability

SMMS-u integrates new features to adapt operations to local constraints with a constant target: the alliance of comfort and energy savings.

- Split heat exchanger
- Demand control
- Autobackup function
- Rotation drive
- Balance oil circuit free
- Small capacity indoor units
- Continuous heating
- 25/+52°C operation

## FLEXIBLE DESIGN AND QUICK INSTALLATION

### Piping design flexibility

Toshiba's piping technology makes them one of the industries leaders in system flexibility and ease of installation and with the e-series VRF system, the level of flexibility has increased further, giving more options to the contractor and installer alike.

### Simplified connection

For a clean installation, Y joints are used to connect outdoor units and indoor units thereby limiting the number of bends and brazes.

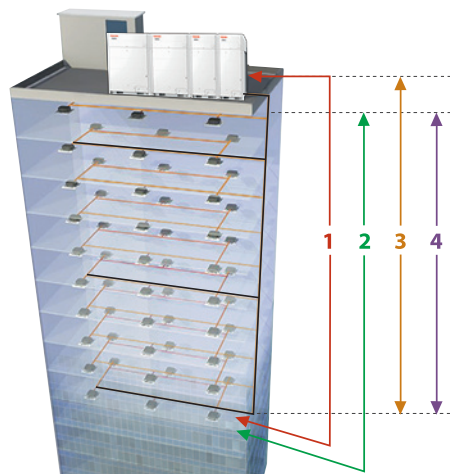

- 1** Total piping length: up to 1,200 m
- 2** Farthest equivalent length: up to 250 m
- 3** Equivalent length of farthest piping from 1<sup>st</sup> branching: up to 90 m
- 4** Height between outdoor unit and indoor unit: up to 110 m

# PROJECT REFERENCES

## OFFICE BUILDING

### Project

**LANDMARK**

180,000 sqm multi-storey, grade A office

Manchester, UK

### Constraints

- 3-pipe solution
- Multi-storey building
- Rooftop CDU integration

### Installer

**CASTLE BUILDING**

Services Ltd

Hebburn, UK

### TOSHIBA SOLUTION



SHRM-e



Duct



Image rights: Toshiba Carrier UK Ltd



Images rights: AIR-COND / Photographer Simon Fischbacher: www.simonfischbacher.at



## INDUSTRY

### Project

**KSK TRANSPORT**

Transshipment warehouse for sensitive medical products

Paternion, Austria

### Constraints

- Highly sensitive freight
- Mix storage/office
- Hot water production needed

### Installer

**EBA**

Cooling Systems GmbH

Obervogau, Austria

### TOSHIBA SOLUTION



14HP SMMS-e x2



4HP Cassette x2



4HP Ceiling x6



2HP High-wall x4



## HOTEL

### Project

**GENNADI GRAND RESORT HOTEL**

Luxury five-star hotel guest-room air-conditioning

Rhodes Island, Greece

### Constraints

- Grade A high efficiency building
- Low-height architecture
- Sea-side location

### Installer

**RODOS AIR**

Rhodes Island, Greece

### TOSHIBA SOLUTION



SMMS-e



Slim Duct

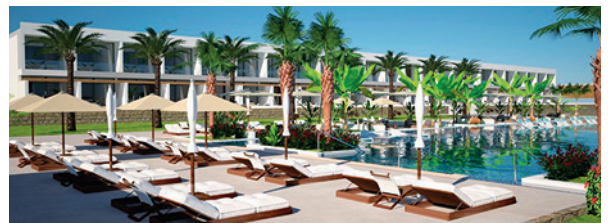

# CHOOSE YOUR ADAPTED SYSTEM SOLUTION MAPPING BY APPLICATIONS

## > OUTDOOR UNITS

### Residential



### Light commercial



### Business



Reversible cooling or heating



MiNi SMMS Sideblow  
1 fan & 2 fans

Individual housing mainly

Up to 250 m<sup>2</sup>  
per system  
Max. 10 IDUs  
per system



Up to 250 m<sup>2</sup> per system and max. 10 IDUs per system  
1 phase electrical power supply only



MiNi SMMS-e 1Ph & 3Ph

Individual housing mainly

Up to 400 m<sup>2</sup> per system  
Max. 16 IDUs per system



Stand alone SMMS-e,  
SMMS-e & SMMS-u

Collective housing mainly



3-phase electrical  
power supply only

Up to 6,000 m<sup>2</sup> per system  
Max. 128 IDUs per system

Simultaneous cooling  
& heating



SHRM-e

Collective housing mainly



3-phase electrical  
power supply only

Up to 2,500 m<sup>2</sup> per system  
Max. 64 IDUs per system  
Hot water production capability







## > INDOOR UNITS

<b>Cassette</b>		o (4-way standard or compact)	o (All types)	o (4-way standard or compact for lobby)	o (All types)
<b>Duct</b>	o (Standard duct)	o (Standard or high static pressure)	o (Slim or standard)	o (Slim for rooms & standard for lobby)	o
<b>High-wall</b>	o	o	o	o (For rooms - low sound version)	o
<b>Ceiling</b>		o			o
<b>Console</b>	o (Bi-flow version)		o	o (For lobby)	o

The data provided on this page is for informational purposes only and not for the purpose of providing legal or other professional advice.



### OUTDOOR UNIT MAPPING FOR EUROPE

												
		R410A	R410A	R410A	R410A			R410A	R410A			
		MCY-MHP_4HT-E	MCY-MHP_4HS-E	MCY-MHP_HS8-E	MMY-SAP_6HT8P-E	MMY-MAP_6HT8P-E			MMY-MUP_1HT8P-E	MMY-MAP_6FT8P-E		
		Heat pump			Heat pump	Heat pump			Heat pump			
					Single module /Stand alone	Single module	Standard combinations	High efficiency / High capacity combination	Single module	Standard combinations	Single module	Combinations
4		●▼	●▼	●▼								
5		●▼	●▼	●▼								
6		●▼	●▼	●▼								
8				●▼	●▼	●▼			●▼		●▼	
10				●▼	●▼	●▼			●▼		●▼	
12				●▼	●▼	●▼			●▼		●▼	
14						●▼			●▼		●▼	
16						●▼			●▼	●	●▼	
18						●▼			●▼	●	●▼	
20						●▼		●	●▼	●	●▼	
22						●▼		●	●▼	●		●
24							●		●▼	●		●
26							●			●		●
28							●			●		●
30							●			●		●
32							●			●		●
34							●			●		●
36							●	●		●		●
38							●	●		●		●
40							●	●		●		●
42							●	●		●		●
44							●	●		●		●
46							●			●		●
48							●			●		●
50							●			●		●
52							●			●		●
54							●	●		●		●
56							●			●		●
58							●			●		●
60							●			●		●
...										●		
120										●		
Fresh air solution	Fresh air duct					●	●	●	●	●		
	Air to Air heat exchanger + DX coil		●	● (4, 5 & 6HP only)		●	●	●			●	●
	Standard DX Kit	●	●	●		●	●	●			●	●
	0/10v DX kit					●	●	●				
Hot water	Hot water module			● (8 & 10P only)		●	●	●	●	●		
Small capacity indoor units	0.3HP indoor unit								●	●		
	0.6HP indoor unit	● (4 & 5HP only)	●	●	●	●	●	●	●	●	●	●
Accessories	Leak detection	●	●	●	●	●	●	●	●	●	●	●
	Leak detection with pump down		●	● (4, 5 & 6HP only)	●	●	●	●			●	●



●:Heat pump - ▼:Eurovent certified 

MCY-MHP\_HP  
SIDE BLOW



CAPACITY

OPERATION



4HP > 6HP

-20°C > +46°C

Compact, efficient, adaptable, energy saver, the side blow VRF is the solution to cool and heat small/medium size buildings.

Features

Outdoor unit		HP	MCY-	MHP0406HT-E	MHP0506HT-E1	MHP0604HT-E
Capacity range		HP		4	5	6
Cooling capacity		kW		12.1	14.0	15.5
Heating capacity		kW		12.5	16.0	18.0
Power supply		V-ph-Hz		1 phase 50Hz 220/230/240V 1 phase 60Hz 220V	1 phase 50Hz 220/230/240V 1 phase 60Hz 220V	1 phase 50Hz 220/230/240V
Efficiency	EER rated	W/W		3.73	3.23	3.56
	EER 50% load	W/W		6.10	4.93	5.74
	SEER	η/std		320.20%/8.08	307.8%/7.77	365.4%/9.21
Efficiency	COP rated	W/W		4.42	4.00	4.00
	COP 50% load	W/W		5.25	5.48	5.88
	COP -7°C 100% load	W/W		3.88	3.47	3.57
	SCOP	η/std		150.2%/3.83	152.2%/3.88	165.4%/4.21
Electrical characteristics	Running current	A	C	14.4/13.8/13.2	20.8/19.9/19.0	20.6 / 19.7 / 18.9
	Power input	kW	C	3.24	4.34	4.35
	Running current	A	H	13.4/12.8/12.3	19.1/18.3/17.5	21.3 / 20.4 / 19.5
	Power input	kW	H	2.83	4.00	4.5
Dimensions (h x w x d)		mm		910x990x390	910x990x390	1235x990x390
Weight		kg		100	100	116
Compressor	Type			Hermetic twin rotary compressor	Hermetic twin rotary compressor	Hermetic twin rotary compressor
	Motor output	kW		3.75	3.75	3.75
Fan unit	Type			Propeller fan (Quantity 1)	Propeller fan (Quantity 1)	Propeller fan (Quantity 2)
	Motor output	W		100	100	100 + 100
	Air volume	m³/h		4020	4260	6410
External static pressure available		Pa				20
R410A refrigerant charge		kg		3.3	3.3	3.9
		CO <sub>2</sub> Teq		6.9	6.9	8.1
Power supply wiring	MCA	A		26.5	28.0	28.0
	MCOP	A		32.0	32.0	32.0
Pipe connection	Gas line type - Diameter			Flare - 5/8"	Flare - 5/8"	Flare - 3/4"
	Liquid line type - Diameter			Flare - 3/8"	Flare - 3/8"	Flare - 3/8"
Connectivity	Max. number of connected indoor units			8	10	6
	Diversity ratio	Min/Max			80/130%	80/130%
Sound pressure level	Cooling	dB(A)	C	54.0	55.0	52.0
	Heating	dB(A)	H	57.0	58.0	55.0
Sound power level	Cooling	dB(A)	C	73.0	73.0	71.0
	Heating	dB(A)	H	73.0	74.0	70.0
Operation temperature range	Cooling	CDB	C		-5/+46	
	Heating	CWB	H		-20/+15	

C = Cooling mode  
H = Heating mode

Drawings

Unit: mm

MCY-MHP0406HT-E  
MCY-MHP0506HT-E1

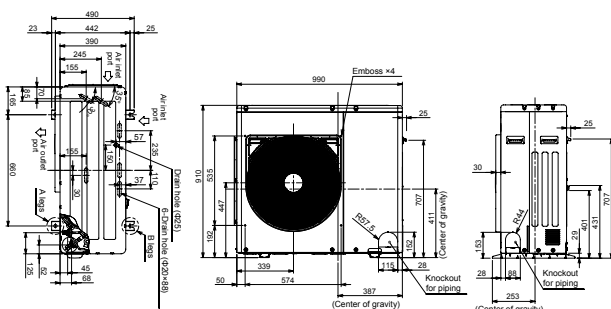

MCY-MHP0604HT-E

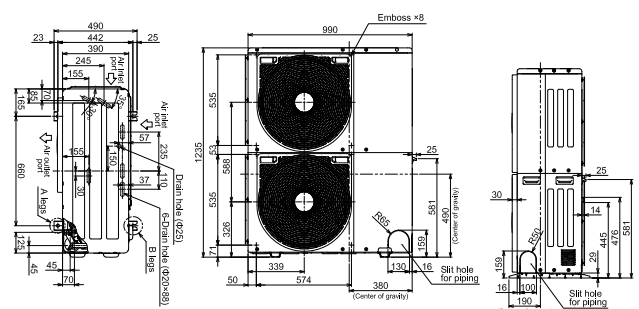

### Piping rules

		Allowable value			
		With PMV kit	Without PMV kit	Piping section	
Piping length	Total extension of pipe (Liquid pipe, real length)	75m	90m	L1 + L2 + L3 + a + b + c + d + e + f	
	Farthest piping length	Equivalent length	50m	60m	L1 + L3 + f
		Real length	40m	50m	
	Max equivalent length of main piping	25m	30m	L1	
	Max equivalent length of farthest piping form 1st branching	15m	20m	L3 + f	
	Max. real length of indoor unit connecting piping	10m	10m	a, b, c, d, e, f	
Real length between PMV kit and indoor unit	-	Between 2m and 10m			
Difference in height	Height between indoor and outdoor units	Upper outdoor unit	15m	15m	
		Lower outdoor unit	15m	15m	
	Height between indoor unit and PMV kit	Upper outdoor unit	10m	-	

### Sound pressure levels

Unit: dB(A)

MCY-MHP0406HT-E

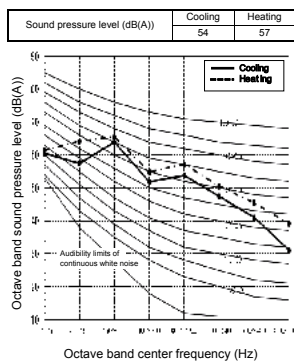

MCY-MHP0506HT-E1

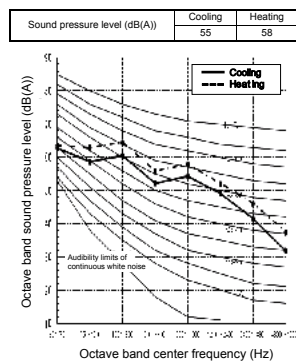

MCY-MHP0604HT-E

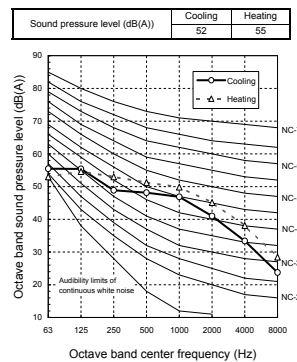

### Night mode sound pressure levels

Sound reduction and capacity approximation (Reference)

Type	Night operation sound reduction dB (A)	Capacity	
		Cooling	Heating
Single fan	0406	Approx. 95%	Approx. 80%
	0506	Approx. 85%	Approx. 75%
Dual fan	0604	Approx. 80%	Approx. 70%

### Accessories

Name	Model name	Capacity	Appearance	Remarks
Branching joints and headers	Y-shape branching joint	Under 6.4hp		
	4-branching header	Under 14.2hp		
	8-branching header	Under 14.2hp		
PM kits	PMV Kits	For 0.6 to 1.3hp IDUs		
		For 1.7 to 3.0hp IDUs		
Optional PCB of outdoor unit	Power peak-cut control board	TCB-PCDM4E		Limit capacity of the VRF outdoor unit at 85%, 75%, 70% or 60% load or stop it. Dry contact
	External master ON/OFF, night mode and priority selection control board	TCB-PCMO4E		Dry contact
	Output control board	TCB-PCIN4E		Operation output: The operation indicator is on while any indoor unit in the system is operating. Error output: The error indicator is on when an error is occurred one of the indoor or outdoor units in the system. Dry contact

MCY-MHP\_HS  
MINI SMMS-e 1PH



Incorporating all of Toshiba's VRF experience and knowledge into a system that measures no more than 1.2 m high, results in a perfect solution for all small to medium building heating and cooling requirements.

CAPACITY

OPERATION



4HP > 6HP

-20°C > +46°C

Features

Outdoor unit	HP	MCY-	MHP0404HS-E	MHP0504HS-E	MHP0604HS-E	
Capacity range	HP		4	5	6	
Cooling capacity	kW		12.1	14.0	15.5	
Heating capacity	kW		12.5	16.0	18.0	
Power supply	V-ph-Hz		1phase 50Hz 220/230/240V	1phase 50Hz 220/230/240V	1phase 50Hz 220/230/240V	
Efficiency	EER rated	W/W	4.28	4.00	3.61	
	EER 50% load	W/W	6.93	6.86	6.78	
	SEER	η/std	373.8%/9.42	366.2%/9.23	384.2%/9.68	
Efficiency	COP rated	W/W	4.83	4.27	4.18	
	COP 50% load	W/W	6.63	6.20	6.16	
	COP -7°C 100% load	W/W	4.28	3.80	3.72	
	SCOP	η/std	163.8%/4.17	166.6%/4.24	171.8%/4.37	
Electrical characteristics	Running current	A	C	13.5/13.0/12.4	16.6/15.9/15.2	20.1/19.2/18.4
	Power input	kW	C	2.83	3.50	4.29
	Running current	A	H	12.5/12.0/11.5	17.8/17.0/16.3	20.2/19.3/18.5
	Power input	kW	H	2.59	3.75	4.31
Dimensions (h x w x d)	mm			1235x990x390		
Weight	kg		127	127	127	
Compressor	Type		Hermetic twin rotary compressor		Hermetic twin rotary compressor	
	Motor output	kW		3.75	3.75	3.75
Fan unit	Type		Propeller fan (Quantity 2)	Propeller fan (Quantity 2)	Propeller fan (Quantity 2)	
	Motor output	W	100+100	100+100	100+100	
	Air volume	m³/h	5660	5820	6050	
External static pressure available	Pa		30	30	30	
R410A refrigerant charge	kg		6.4	6.4	6.4	
	CO <sub>2</sub> Teq		13.363	13.363	13.363	
Power supply wiring	MCA	A	23.5	26.5	28.0	
	MCOP	A	32.0	32.0	32.0	
Pipe connection	Gas line type - Diameter		Flare - 5/8"	Flare - 5/8"	Flare - 3/4"	
	Liquid line type - Diameter		Flare - 3/8"	Flare - 3/8"	Flare - 3/8"	
Connectivity	Max. number of connected indoor units		8	10	13	
	Diversity ratio	Min/Max		80/130%		
Sound pressure level	Cooling	dB(A)	C	49	50	51
	Heating	dB(A)	H	52	53	54
Sound power level	Cooling	dB(A)	C	66	68	68
	Heating	dB(A)	H	69	70	71
Operation temperature range	Cooling	CDB	C	-5 to 46	-5 to 46	-5 to 46
	Heating	CWB	H	-20 to 15	-20 to 15	-20 to 15

C = Cooling mode  
H = Heating mode

Drawings

Unit: mm

All models

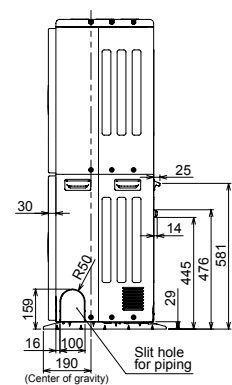
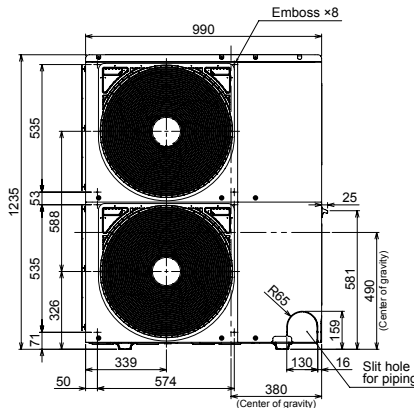
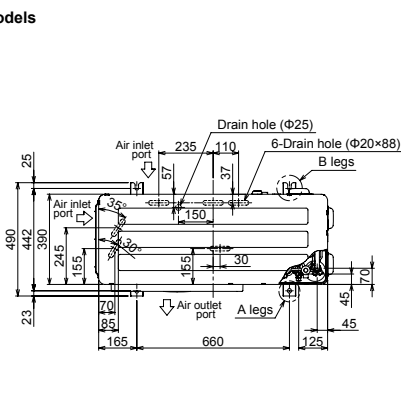

Piping rules

				Allowable value		
				With PMV kit	Without PMV kit	Piping section
Piping length	Total extension of pipe (Liquid pipe, real length)			150m	180m	L1 + L2 + L3 + a + b + c + d + e + f
	Farthest piping length		Equivalent length	80m	125m	L1 + L3 + f
			Real length	65m	100m	
	Max equivalent length of main piping			50m	65m	L1
	Max equivalent length of farthest piping form 1st branching			15m	35m	L3 + f
	Max. real length of indoor unit connecting piping			15m	15m	a, b, c, d, e, f
Real length between PMV kit and indoor unit		Between 2m and 10m		-		
Difference in height	Height between indoor and outdoor units		Upper outdoor unit	30m	30m	
			Lower outdoor unit	20m	20m	
	Height between indoor unit and PMV kit		Upper outdoor unit	15m	-	

Sound pressure levels

Unit: dB(A)

MCY-MHP0404HS-E

Sound pressure level (dB(A))	Cooling	Heating
	49	52

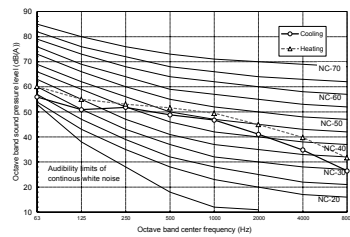

MCY-MHP0504HS-E

Sound pressure level (dB(A))	Cooling	Heating
	50	53

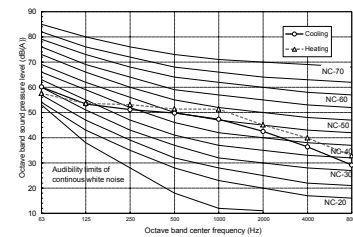

MCY-MHP0604HS-E

Sound pressure level (dB(A))	Cooling	Heating
	51	54

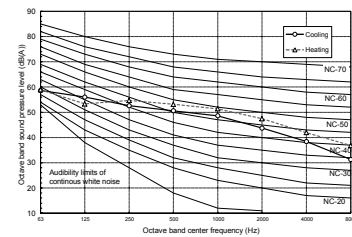

Night mode sound pressure levels

Sound reduction and capacity approximation (Reference)

Outdoor unit (base unit)	Night operation sound reduction dB (A)		Capacity*	
	Cooling	Heating	Cooling	Heating
Model 0404*	46	48	approx. 90 %	approx. 95 %
Model 0504*	46	48	approx. 80 %	approx. 80 %
Model 0604*	47	49	approx. 80 %	approx. 75 %

\*Relative to maximum capacity

Accessories

Name	Model name	Capacity	Appearance	Remarks	
Branching joints and headers	Y-shape branching joint	RBM-BY55E	Under 6.4hp		
	4-branching header	RBM-HY1043E	Under 14.2hp		
	8-branching header	RBM-HY1083E	Under 14.2hp		
PM kits	PMV Kits	RBM-PMV0361U-E	For 0.6 to 1.3hp IDUs		
		RBM-PMV0901U-E	For 17 to 3.0hp IDUs		
Optional PCB of outdoor unit	Power peak-cut control board	TCB-PCDM4E			Limit capacity of the VRF outdoor unit at 85%, 75%, 70% or 60% load or stop it. Dry contact
	External master ON/OFF, night mode and priority selection control board	TCB-PCMO4E			Dry contact
	Output control board	TCB-PCIN4E			Operation output: The operation indicator is on while any indoor unit in the system is operating. Error output: The error indicator is on when an error is occurred on even one of the indoor or outdoor units in the system. Dry contact

MCY-MHP\_HS8  
MINI SMMS-e 3PH



CAPACITY

OPERATION



4HP > 10HP

-20°C > +46°C

Up to 10HP capacity using compact sideblow chassis, the MINI SMMS-e 3PH is particularly adapted to projects downtown the cities.

Features

Outdoor unit	HP	MCY-	MHP0404HS8-E	MHP0504HS8-E	MHP0604HS8-E	MHP0806HS8-E	MHP1006HS8-E	
Capacity range	HP		4	5	6	8	10	
Cooling capacity	kW		12.1	14.0	15.5	22.4	28.0	
Heating capacity (rated/max)	kW		12.5	16.0	18.0	22.4/25.0	28.0/31.5	
Power supply	V-ph-Hz		3 phase 50Hz 380/400/415V	3 phase 50Hz 380/400/415V	3 phase 50Hz 380/400/415V	3 phase 50Hz 380/400/415V	3 phase 50Hz 380/400/415V	
Efficiency	EER rated	W/W	4.29	4.03	3.65	3.36	3.00	
	EER 50% load	W/W	6.93	6.48	5.91	5.69	5.19	
	SEER	η/std	375.8%/9.47	368.6%/9.29	386.6%/9.74	320.6%/8.09	293.0%/7.40	
Efficiency	COP rated	W/W	4.86	4.30	4.22	4.31	4.00	
	COP 50% load	W/W	6.70	6.25	6.25	6.05	5.62	
	COP -7°C 100% load	W/W	4.32	3.83	3.75	3.51	3.27	
	SCOP	η/std	164.6%/4.19	167.0%/4.25	172.2%/4.38	177.0%/4.50	179.8%/4.57	
Electrical characteristics	Running current	A	C	4.8/4.5/4.4	5.7/5.4/5.2	7.0/6.7/6.4	11.0/10.6/10.2	15.3/14.5/14.0
	Power input	kW	H	2.82	3.47	4.25	6.67	9.33
	Running current	A	C	4.4/4.2/4.0	6.1/5.8/5.6	7.0/6.6/6.4	8.7/8.2/7.9	11.4/10.9/10.5
	Power input	kW	H	2.57	3.72	4.27	5.20	7.00
Dimensions (h x w x d)	mm			1235x990x390		1740x990x390		
Weight	kg		125	125	125	147	147	
Compressor	Type		Hermetic twin rotary compressor	Hermetic twin rotary compressor	Hermetic twin rotary compressor	Hermetic twin rotary compressor	Hermetic twin rotary compressor	
	Motor output	kW		3.75	3.75	3.75	6.60	6.60
Fan unit	Type		Propeller fan (Quantity 2)	Propeller fan (Quantity 2)	Propeller fan (Quantity 2)	Propeller fan (Quantity 2)	Propeller fan (Quantity 2)	
	Motor output	W		100+100	100+100	100+100	100+100	
	Air volume	m³/h		5660	5820	6050	8460	8820
External static pressure available	Pa		30	30	30	20	20	
R410A refrigerant charge	kg		6.4	6.4	6.4	4.4	4.4	
	CO <sub>2</sub> Teq		13.36	13.36	13.36	9.19	9.19	
Power supply wiring	MCA	A	12.5	12.5	12.5	17.0	20.0	
	MCOP	A	16.0	16.0	16.0	20.0	25.0	
Pipe connection	Gas line type - Diameter		Flare - 5/8"	Flare - 5/8"	Flare - 3/4"	Flare - 3/4"	Flare - 7/8"	
	Liquid line type - Diameter		Flare - 3/8"	Flare - 3/8"	Flare - 3/8"	Flare - 3/8"	Flare - 3/8"	
Connectivity	Max. number of connected indoor units		8	10	13	12	16	
	Diversity ratio	Min/Max			80/130%			
Sound pressure level	Cooling	dB(A)	C	49	50	51	58	59
	Heating	dB(A)	H	52	53	54	59	60
Sound power level	Cooling	dB(A)	C	66	68	68	75	77
	Heating	dB(A)	H	67	69	70	75	77
Operation temperature range	Cooling	CDB	C	-5 to 46	-5 to 46	-5 to 46	-5 to 46	-5 to 46
	Heating	CWB	H	-20 to 15	-20 to 15	-20 to 15	-20 to 15	-20 to 15

C = Cooling mode  
H = Heating mode

Drawings

Unit: mm

MCY-MHP\_4HS8-E

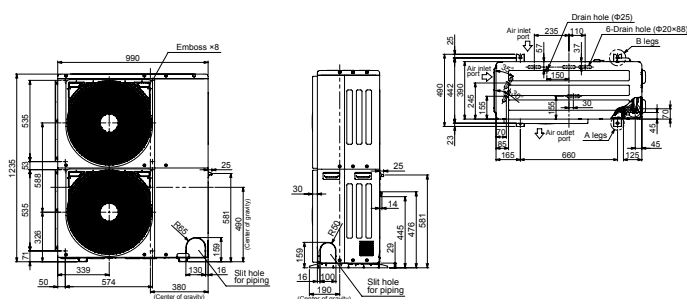

MCY-MHP\_6HS8-E

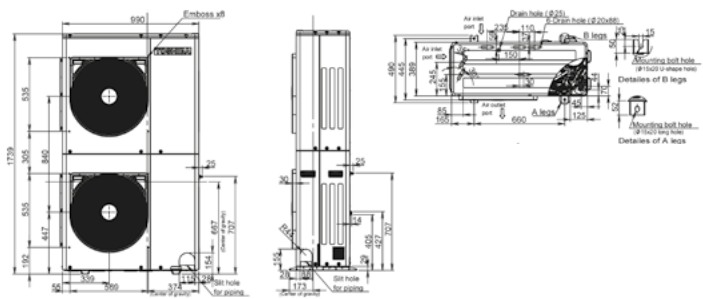

Piping rules

			Allowable value			
			With PMV kit		Without PMV kit	
			4 to 6HP	8 & 10HP	4 to 6HP	8 & 10HP
Piping length	Total extension of pipe (Liquid pipe, real length)	150m	250m	180m	300m	
	Farthest piping length	Equivalent length	80m	130m	125m	150m
		Real length	65m	100m	100m	120m
	Max equivalent length of main piping	50m	70m	65m	80m	
	Max equivalent length of farthest piping form 1st branching	15m	30m	35m	40m	
	Max. real length of indoor unit connecting piping	15m		15m		
Real length between PMV kit and indoor unit	Between 2m and 10m		-			
Difference in height	Height between indoor and outdoor units	Upper outdoor unit	30m			
		Lower outdoor unit	20m	30m	20m	30m
	Height between indoor units	15m		15m		

(\*1): (D) is outdoor unit furthest from the 1st branch and (I) is the indoor unit furthest from the 1st branch.  
 (\*2): If the height difference (H1) between indoor and outdoor unit exceeds 3 m, set 65 m or less.  
 (\*3): If the max. combined outdoor unit capacity is 54HP or more, then max. equivalent length is 70 m or less (real length is 60 m or less).  
 (\*4): If the height difference (H2) between indoor units exceeds 3 m, set 50 m or less.

(\*5): If the height difference (H2) between indoor units exceeds 3 m, set 30 m or less.  
 (\*6): Total charging refrigerant is 140kg or less.  
 (\*7): Extension up till 90m is possible with conditions below  
 - Outdoor Temperature Cooling : 10 - 46 (DB)  
 Heating : -5 - 15.5 (WB)  
 - Equivalent length of farthest piping from 1st branching Li < 50m  
 - Real length of main piping L1 < 100m

- Height difference between indoor units H2<3M  
 - Total capacity of combined indoor units : 90% - 105%  
 - Single CDU, and up to 20HP  
 - Minimum capacity of connectable indoor : unit 4HP or Larger

Sound pressure levels

Unit: dB(A)

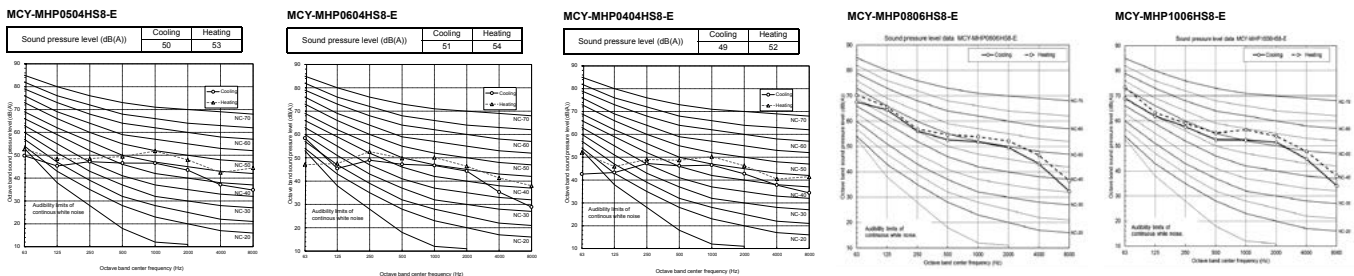

Night mode sound pressure levels

Sound reduction and approximation capacity (Reference)

Outdoor unit (base unit)	Night operation sound reduction dB(A)		Capacity*	
	Cooling	Heating	Cooling	Heating
Model 0404*	46	48	approx. 90%	approx. 95%
Model 0504*	46	48	approx. 80%	approx. 80%
Model 0604*	47	49	approx. 80%	approx. 75%
Model 0806*	50	50	approx. 80%	approx. 75%
Model 1006*	50	50	approx. 65%	approx. 60%

\*Relative to maximum capacity

Accessories

	Name	Model name	Capacity	Appearance	Remarks
Branching joints and headers	Y-shape branching joint	RBM-BY55E	under 6.4hp		
		RBM-BY105E	between 6.4 and 20.2hp		
	4-branching header	RBM-HY1043E	under 14.2hp		
	8-branching header	RBM-HY1083E	under 14.2hp		
PM kits	PMV Kits	RBM-PMV0361U-E	for 0.6 to 1.3hp IDUs		
		RBM-PMV0901U-E	for 17 to 3.0hp IDUs		
Optional PCB of outdoor unit	Power peak-cut control board	TCB-PCDM4E			"Limit capacity of the VRF outdoor unit at 85%, 75%, 70% or 60% load or stop it. Dry contact"
	External master ON/OFF, night mode and priority selection control board	TCB-PCMO4E			Dry contact
	Output control board	TCB-PCIN4E			"Operation output: The operation indicator is on while any indoor unit in the system is operating. Error output: The error indicator is on when an error is occurred on even one of the indoor or outdoor units in the system. Dry contact"

# MMY-SAP\_HT8P SMMS-e STAND ALONE



CAPACITY OPERATION



8HP > 12HP

-25°C > 46°C

Keep all benefits of Toshiba SMMS-e with 50% less precharge refrigerant: new intelligent and innovative features that maximise end user comfort and system efficiencies.

## Features

Outdoor unit	HP	MMY-	SAP0806HT8P-E	SAP1006HT8P-E	SAP1206HT8P-E	
Capacity range	HP		8	10	12	
Cooling capacity <sup>1</sup>	kW		22.4	28.0	33.5	
Heating capacity <sup>2</sup>	kW		25.0	31.5	37.5	
Power supply	V-ph-Hz		380/415-3-50	380/415-3-50	380/415-3-50	
Efficiency	EER rated	W/W	4.04	3.54	3.25	
	EER 50% load	W/W	6.4	6.06	5.68	
	SEER	η/std	249.8%/6.32	244.2%/6.18	241%/6.10	
Efficiency	COP rated	W/W	4.42	4.15	3.84	
	COP 50% load	W/W	6.31	5.85	5.37	
	COP -7°C 100% load	W/W	3.58	3.32	3.02	
	SCOP	η/std	148.6%/3.79	149.4%/3.81	144.2%/3.68	
Electrical characteristic	Running current	A	C	8.8	12.4	16.0
	Power input	kW	C	5.54	7.91	10.31
	Running current	A	H	9.0	11.9	15.1
	Power input	kW	H	5.66	7.59	9.77
Dimensions (h x w x d)	mm		1830x990x780	1830x990x780	1830x990x780	
Weight	kg			227		
Compressor	Type			Hermetic Twin Rotary		
	Motor output	kW		2.1x2	3.1x2	3.9x2
Fan unit	Type			Propeller fan		
	Motor output	W		1	1	1
	Air volume	m <sup>3</sup> /h			9700	12200
External static pressure available	Pa		60	60	50	
R410A refrigerant charge	kg		5.7	5.7	5.7	
	CO <sub>2</sub> Teq		11.90	11.90	11.90	
Power supply wiring	MCA	A	20.5	21.5	26.1	
	MCOP	A	25.0	25.0	32.0	
Pipe connection	Gas line type - Diameter		Brazed - 3/4"	Brazed - 7/8"	Brazed - 1-1/8"	
	Liquid line type - Diameter		Flare - 1/2"	Flare - 1/2"	Flare - 1/2"	
Connectivity	Max. number of connected indoor units		18	22	27	
	Diversity ratio	Min/Max		50/135%		
Sound pressure level	Cooling	dB(A)	C	55	57	59
	Heating	dB(A)	H	56	58	61
Sound power level	Cooling	dB(A)	C	74	74	80
	Heating	dB(A)	H	74	74	82
Operation temperature range	Cooling	CDB	C	-10/46		
	Heating	CWB	H	-25/15.5		

C = Cooling mode  
H = Heating mode

## Drawings

Unit: mm

All models

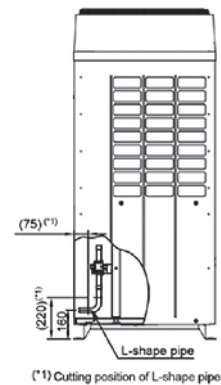
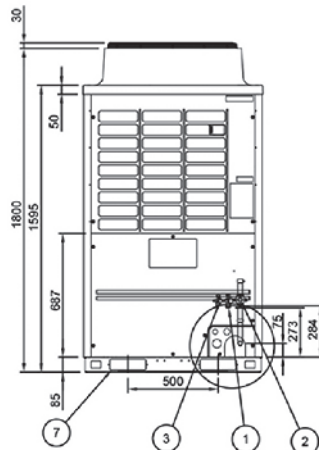
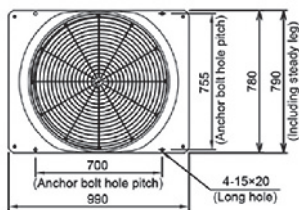



### Piping rules

		Allowable value	Piping section	
Piping length	Total extension of pipe (Liquid pipe, real length)	300m	LA + LB + La + Lb + Lc + L1 + L2 + L3 + L4 + L5 + L6 + L7 + a + b + c + d + e + f + g + h + i + j	
	Farthest piping length	Equivalent length	235m	
		Real length	190m	LA + L1 + L3 + L4 + L5 + L6 + j
	Equivalent length of farthest piping form 1st branching	90m	L3 + L4 + L5 + L6 + j	
	Max. equivalent length of main piping	Equivalent length	120m	L1
		Real length	100m	
Max. real length of indoor unit connecting piping		30m	a, b, c, d, e, f, g, h, i, j	
Max. equivalent length between branches		50m	L2, L3, L4, L5, L6, L7	
Difference in height	Height between indoor and outdoor units	Upper outdoor unit	70m	
		Lower outdoor unit	40m	
	Height between indoor units		40m	

(\*1) : (D) is outdoor unit farthest from the 1st branch and (I) is the indoor unit farthest from the 1st branch.  
 (\*2) : If the height difference (H1) between indoor and outdoor unit exceeds 3 m, set 65 m or less.  
 (\*4) : If the height difference (H2) between indoor units exceeds 3 m, set 50 m or less.  
 (\*5) : If the height difference (H2) between indoor units exceeds 3 m, set 30 m or less  
 (\*7) : Extension up till 90m is possible with conditions below

- Outdoor temperature cooling : 10 - 46 (DB)  
 Heating : -5 - 15.5 (WB)  
 - Equivalent length of farthest piping from 1st branching Li < 50 m  
 - Real length of main piping L1 < 100 m  
 - Height difference between indoor units H2<3M  
 - Total capacity of combined indoor units: 90% - 105%  
 - Single CDU, and up to 20HP  
 - Minimum capacity of connectable indoor: unit 4HP or larger

### Sound pressure levels

Unit: dB(A)

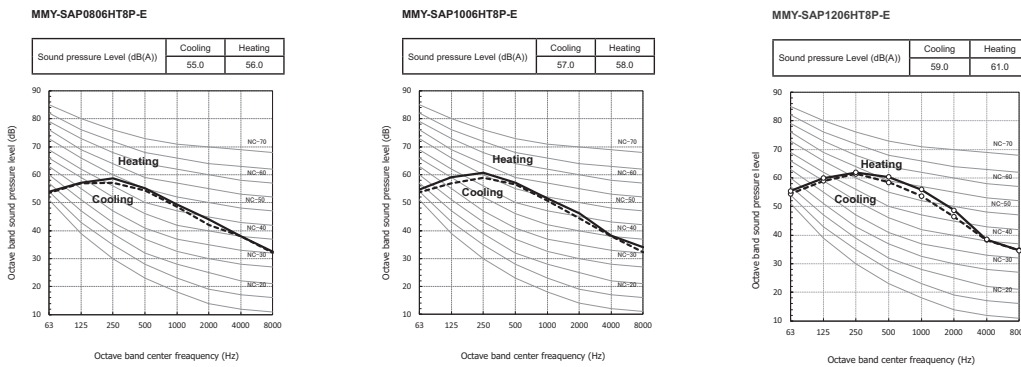

### Night mode sound pressure levels

Sound reduction and capacity approximation (Reference)

	Night operation sound reduction dB (A)	Capacity	
		Cooling	Heating
0806 type	50	Approx. 85%	Approx. 80%
1006 type	50	Approx. 70%	Approx. 65%
1206 type	50	Approx. 60%	Approx. 55%

### Accessories

	Name	Model name	Capacity	Appearance	Remarks
Branching joints and headers	Y-shape branching joint	RBM-BY55E	Under 6.4hp		
		RBM-BY105E	From 6.4 to 14.2hp		
		RBM-BY205E	From 14.2 to 25.2hp		
		RBM-BY305E	25.2hp or more		
	4-branching header	RBM-HY1043E	Under 14.2hp		
		RBM-HY2043E	From 14.2 to 25.2hp		
8-branching header	RBM-HY1083E	Under 14.2hp			
	RBM-HY2083E	From 14.2 to 25.2hp			
Optional PCB of outdoor unit	Power peak-cut control board	TCB-PCDM4E			Limit capacity of the VRF outdoor unit at 85%, 75%, 70% or 60% load or stop it. Dry contact
	External master ON/OFF control board	TCB-PCMO4E			Dry contact
	Output control board	TCB-PCIN4E			Operation output : The operation indicator is on while any indoor unit in thesystem is operating. Error output : The error indicator is on when an error is occurred on evenone of the indoor or outdoor units in the system. Dry contact



CAPACITY

OPERATION



8HP > 120HP



-25°C > +52°C

With new chassis, new compressor, new heat exchanger, the SMMS-u, latest generation of Toshiba VRF, is achieving unrivalled efficiency and comfort level.

Features

PRELIMINARY DATA

Outdoor unit		MMY-	MUP0801HT8P-E	MUP1001HT8P-E	MUP1201HT8P-E	MUP1401HT8P-E	MUP1601HT8P-E	MUP1801HT8P-E	MUP2001HT8P-E	MUP2201HT8P-E	MUP2401HT8P-E	
Capacity range	HP		8 HP	10 HP	12 HP	14 HP	16 HP	18 HP	20 HP	22 HP	24HP	
Cooling capacity	kW		22.4	28.0	33.5	40.0	45.0	50.4	56.0	61.5	67.0	
Heating capacity +7°C (rated/max)	kW		22.4/25.0	28.0/31.5	33.5/37.5	40.0/45.0	45.0/50.0	50.4/56.0	56.0/63.0	61.5/69.0	67.0/70.0	
Power supply	V-ph-Hz		380/415-3-50	380/415-3-50	380/415-3-50	380/415-3-50	380/415-3-50	380/415-3-50	380/415-3-50	380/415-3-50	380/415-3-50	
Efficiency	EER rated	W/W	3.97	3.35	3.24	2.75	3.20	3.17	3.11	3.01	2.77	
	EER 50% load	W/W	6.75	6.64	6.36	5.62	6.25	6.19	6.31	6.06	5.66	
	SEER	η/std	294.6%/7.44	306.2%/7.73	289.8%/7.32	279.0%/7.05	305.4%/7.71	304.2%/7.68	301.8%/7.62	286.2%/7.23	271.2%/6.87	
Efficiency	COP rated	W/W	4.24	3.89	4.31	4.00	3.77	4.02	3.75	3.80	3.53	
	COP 50% load	W/W	4.81	4.57	4.96	4.82	4.69	4.57	4.33	4.21	3.62	
	COP -7°C 100% load	W/W	3.37	3.07	3.42	3.00	2.88	3.06	2.88	2.94	2.73	
	SCOP	η/std	177.0%/4.5	188.2%/4.78	184.7.0%/4.75	181.0%/4.6	188.6%/4.79	187.0%/4.75	174.2%/4.43	174.6%/4.44	163.8%/4.17	
Electrical characteristic	Running current	A	C	9.1	13.4	16.0	22.6	21.6	24.4	27.7	31.4	37.1
	Power input	kW	C	5.64	8.36	10.34	14.55	14.06	15.90	18.01	20.43	24.19
	Running current	A	H	8.6	11.5	12.1	15.5	18.3	19.3	22.9	24.8	29.1
	Power input	kW	H	5.28	7.20	7.77	10.00	11.94	12.54	14.93	16.18	18.98
Dimensions (h x w x d)	mm		1690 x 990 x 780	1690 x 990 x 780	1690 x 990 x 780	1690 x 990 x 780	1690 x 1290 x 780	1690 x 1290 x 780	1690 x 1290 x 780	1690 x 1290 x 780	1690 x 1290 x 780	
Weight	kg		228	228	228	228	312	312	334	356	356	
Compressor	Type		Hermetic Twin Rotary	Hermetic Twin Rotary	Hermetic Twin Rotary	Hermetic Twin Rotary	Hermetic Triple Rotary	Hermetic Triple Rotary	Hermetic Triple Rotary	Hermetic Twin Rotary	Hermetic Twin Rotary	
	Motor output	kW	5.31	6.44	8.23	10.8	11.7	14.0	15.9	9.29x2	10.7x2	
Fan unit	Type		Propeller fan									
	Motor output	kW	1.0	1.0	1.0	1.0	2.0	2.0	2.0	2.0	2.0	
	Air volume	m3/h	9900	10500	11700	11880	15300	16800	15900	16500	16500	
External Static pressure available	Pa		80	80	80	80	80	80	80	80	80	
Refrigerant charge R410A	kg		6.0	6.0	6.0	6.0	9.0	9.0	9.0	9.0	9.0	
	CO <sub>2</sub> Teq		12.53	12.53	12.53	12.53	18.79	18.79	18.79	18.79	18.79	
Power supply wiring	MCA	A	17	23	27	31	34	38	40	57	60	
	MCOP	A	20	32	32	40	40	50	50	63	80	
Pipe connection	Gas line type - diameter		Brazed - 3/4"	Brazed - 7/8"	Brazed - 1-1/8"	Brazed - 1-1/8"	Brazed - 1-1/8"	Brazed - 1-1/8"	Brazed - 1-1/8"	Brazed - 1-1/8"	Brazed - 1-3/8"	
	Liquid line type - diameter		Brazed - 1/2"	Brazed - 1/2"	Brazed - 1/2"	Brazed - 5/8"	Brazed - 5/8"	Brazed - 5/8"	Brazed - 5/8"	Brazed - 3/4"	Brazed - 3/4"	
Max. number of connected indoor units			18	22	27	31	36	40	45	49	54	
Sound pressure level	Cooling	dB(A)	C	53	55	58	58	60	61	63	63	63
	Heating	dB(A)	H	56	58	62	62	63	67	67	67	67
Sound power level	Cooling	dB(A)	C	75	77	79	79	83	84	86	86	86
	Heating	dB(A)	H	76	77	81	82	86	89	90	90	90
Operatin Temperature range	Cooling	CDB	C	-10/52								
	Heating	CWB	H	-25/15.5								

C = Cooling mode H = Heating mode

Installation space

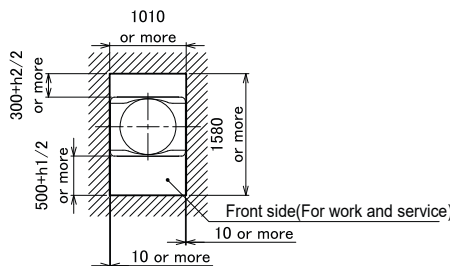

Space required for service

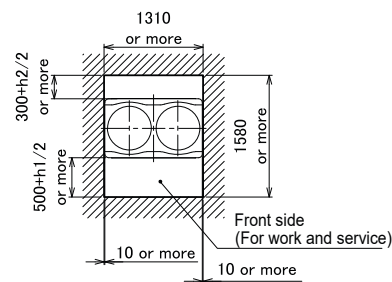

















Leave space necessary for running, installation and servicing.

- If there is an obstacle above the outdoor unit, leave a space of 2000 mm or more to the top end of the outdoor unit.
- If there is a wall around the outdoor unit, make sure that its height does not exceed 800 mm.

Also applicable for SMMS-e stand alone and SHRME

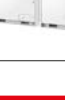
Capacity table

Capacity		Combination	Modèle	EER/SEER	COP/SCOP	Max indoor connectivity	
HP	Cooling/Heating in kW						
8	22.4/22.4	8	MMY-MUP0801HT8P-E	3.97/7.44	4.24/4.50	18	
10	28.0/28.0	10	MMY-MUP1001HT8P-E	3.35/7.73	3.89/4.78	22	
12	33.5/33.5	12	MMY-MUP1201HT8P-E	3.24/7.32	4.31/4.75	27	
14	40.0/40.0	14	MMY-MUP1401HT8P-E	2.75/7.05	4.00/4.60	31	
16	45.0/45.0	16	MMY-MUP1601HT8P-E	3.20/7.71	3.77/4.79	36	
18	50.4/40.5	18	MMY-MUP1801HT8P-E	3.17/7.68	4.02/4.75	40	
20	56.0/56.0	20	MMY-MUP2001HT8P-E	3.11/7.62	3.75/4.43	45	
22	61.5/61.5	22	MMY-MUP2201HT8P-E	3.01/7.23	3.80/4.44	49	
24	67.0/67.0	24	MMY-MUP2401HT8P-E	2.77/6.87	3.53/4.17	54	
26	73.5/73.5	14 + 12	MMY-UP2611HT8P-E	2.95/7.17	4.14/4.67	58	
28	80.0/80.0	14 + 14	MMY-UP2811HT8P-E	2.75/7.05	4.00/4.6	63	
30	83.9/83.9	18 + 12	MMY-UP3011HT8P-E	3.20/7.52	4.13/4.75	64	
32	89.5/89.5	20 + 12	MMY-UP3211HT8P-E	3.16/7.50	3.94/4.55	65	
34	96.0/96.0	20 + 14	MMY-UP3411HT8P-E	2.95/7.38	3.85/4.50	66	
36	100.5/100.5	24 + 12	MMY-UP3611HT8P-E	2.91/7.01	3.76/4.38	67	
38	107.0/107.0	24 + 14	MMY-UP3811HT8P-E	2.76/6.93	3.69/4.33	68	
40	112.0/112.0	20 + 20	MMY-UP4011HT8P-E	3.11/7.62	3.75/4.43	69	
42	117.4/117.4	24 + 18	MMY-UP4211HT8P-E	2.93/7.22	3.72/4.43	70	
44	123.0/123.0	24 + 20	MMY-UP4411HT8P-E	2.91/7.21	3.63/4.30	71	
46	128.5/128.5	24 + 22	MMY-UP4611HT8P-E	2.88/7.04	3.65/4.31	72	
48	134.0/134.0	24 + 24	MMY-UP4811HT8P-E	2.77/6.87	3.53/4.17	73	
50	140.5/140.5	24 + 14 + 12	MMY-UP5011HT8P-E	2.86/7.02	3.82/4.44	74	
52	147.0/147.0	24 + 14 + 14	MMY-UP5211HT8P-E	2.76/6.96	3.77/4.41	75	
54	152.0/152.0	20 + 20 + 14	MMY-UP5411HT8P-E	3.01/7.49	3.81/4.47	76	
56	156.5/156.5	24 + 20 + 12	MMY-UP5611HT8P-E	2.98/7.23	3.75/4.41	77	
58	163.0/163.0	24 + 20 + 14	MMY-UP5811HT8P-E	2.87/7.19	3.71/4.37	78	
60	167.5/167.5	24 + 24 + 12	MMY-UP6011HT8P-E	2.85/6.95	3.66/4.3	79	
62	174.0/174.0	24 + 24 + 14	MMY-UP6211HT8P-E	2.76/6.92	3.63/4.27	80	
64	179.0/179.0	24 + 20 + 20	MMY-UP6411HT8P-E	2.97/7.34	3.67/4.34	81	
66	184.5/184.5	24 + 22 + 20	MMY-UP6611HT8P-E	2.95/7.21	3.68/4.35	82	
68	190.0/190.0	24 + 24 + 20	MMY-UP6811HT8P-E	2.86/7.09	3.59/4.26	83	
70	195.5/195.5	24 + 24 + 22	MMY-UP7011HT8P-E	2.84/6.98	3.61/4.26	84	
72	201.0/201.0	24 + 24 + 24	MMY-UP7211HT8P-E	2.77/6.87	3.53/4.17	85	
74	207.5/207.5	24 + 24 + 14 + 12	MMY-UP7411HT8P-E	2.83/6.97	3.72/4.36	86	
76	214.0/214.0	24 + 24 + 14 + 14	MMY-UP7611HT8P-E	2.76/6.93	3.69/4.33	87	
78	219.0/219.0	24 + 20 + 20 + 14	MMY-UP7811HT8P-E	2.93/7.30	3.72/4.39	88	
80	223.5/223.5	24 + 24 + 20 + 12	MMY-UP8011HT8P-E	2.91/7.14	3.68/4.34	90	
82	230.0/230.0	24 + 24 + 20 + 14	MMY-UP8211HT8P-E	2.84/7.10	3.66/4.32	92	
84	234.5/234.5	24 + 24 + 24 + 12	MMY-UP8411HT8P-E	2.83/6.95	3.62/4.26	94	
86	241.0/241.0	24 + 24 + 24 + 14	MMY-UP8611HT8P-E	2.77/6.91	3.60/4.25	96	
88	246.0/246.0	24 + 24 + 20 + 20	MMY-UP8811HT8P-E	2.91/7.21	3.63/4.30	98	
90	251.5/251.5	24 + 24 + 22 + 20	MMY-UP9011HT8P-E	2.97/7.12	3.64/4.30	100	
92	257.0/257.0	24 + 24 + 24 + 20	MMY-UP9211HT8P-E	2.84/7.03	3.58/4.24	102	
94	262.5/262.5	24 + 24 + 24 + 22	MMY-UP9411HT8P-E	2.82/6.95	3.59/4.24	104	
96	268.0/268.0	24 + 24 + 24 + 24	MMY-UP9611HT8P-E	2.77/6.87	3.53/4.17	106	
98	274.5/274.5	24 + 24 + 24 + 14 + 12	MMY-UP9811HT8P-E	2.82/6.95	3.67/4.31	108	
100	281.0/281.0	24 + 24 + 24 + 14 + 14	MMY-UP10011HT8P-E	2.76/6.94	3.65/4.30	110	
102	286.0/286.0	24 + 24 + 20 + 20 + 14	MMY-UP10211HT8P-E	2.89/7.2	3.68/4.34	112	
104	290.5/290.5	24 + 24 + 24 + 20 + 12	MMY-UP10411HT8P-E	2.88/7.08	3.65/4.30	114	
106	297.0/297.0	24 + 24 + 24 + 20 + 14	MMY-UP10611HT8P-E	2.83/7.04	3.63/4.29	116	
108	301.5/301.5	24 + 24 + 24 + 24 + 12	MMY-UP10811HT8P-E	2.82/6.93	3.60/4.24	118	
110	308.0/308.0	24 + 24 + 24 + 24 + 14	MMY-UP11011HT8P-E	2.77/6.90	3.58/4.23	120	
112	313.0/313.0	24 + 24 + 24 + 20 + 20	MMY-UP11211HT8P-E	2.88/7.13	3.61/4.28	122	
114	318.5/318.5	24 + 24 + 24 + 22 + 20	MMY-UP11411HT8P-E	2.87/7.07	3.62/4.28	124	
116	324.0/324.0	24 + 24 + 24 + 24 + 20	MMY-UP11611HT8P-E	2.82/7.00	3.57/4.22	126	
118	329.5/329.5	24 + 24 + 24 + 24 + 22	MMY-UP11811HT8P-E	2.81/6.93	3.58/4.23	128	
120	335.0/335.0	24 + 24 + 24 + 24 + 24	MMY-UP12011HT8P-E	2.77/6.87	3.53/4.17	128	



Piping rules

		Allowable value	Piping section	
Piping length	"Total extension of pipe (Liquid pipe, real length)"	Single ODU	500m	
		Combination ODU	1200m (*6)	
	Farthest piping length (*1)	Equivalent length	250m	
		Real length	210m	
	Equivalent length of farthest piping form 1st branching (*1)	90m (*2)	L3 + L4 + L5 + L6 + j	
	Equivalent length of farthest piping between outdoor units	40m	LA+LB+LC+Le (LA+LB+LC+Ld)	
	Max. equivalent length of main piping	Equivalent length	120m (*3)	L1
		Real length	100m (*3)	
	Max. equivalent length of outdoor unit connecting piping		10m	Le (La, Lb, Lc, Ld)
Max. real length of indoor unit connecting piping		30m	a, b, c, d, e, f, g, h, i, j	
Max. equivalent length between branches		50m	L2, L3, L4, L5, L6, L7	
Difference in height	Height between indoor and outdoor units	Upper outdoor unit	70m (*4)(*7)	
		Lower outdoor unit	40m (*5)(*8)	
	Height between indoor units		50m (*9)	
	Height between outdoor units		5m	

(\*1) : (e) is outdoor unit furthest from the 1st branch and (j) is the indoor unit furthest from the 1st branch.  
 (\*2) : If the height difference (H1) between indoor and outdoor unit exceeds 3 m, set 65 m or less.  
 (\*3) : If the max. combined outdoor unit capacity is 54HP or more, then max. equivalent length is 70 m or less (real length is 50 m or less).  
 (\*4) : If the height difference (H2) between indoor units exceeds 3 m, set 50 m or less.  
 (\*5) : If the height difference (H2) between indoor units exceeds 3 m, set 30 m or less.  
 (\*6) : Total charging refrigerant is 140kg or less.

(\*7) : Extension up till 110m is possible with conditions below :  
 -Single outdoor unit system  
 -Connected ratio of indoor units to outdoor units is below 105%  
 -Liquid side is been increased 1 size from the standard size  
 (\*8) : Extension up till 110m is possible with conditions below :  
 -Multiple outdoor unit system  
 -Connected Ratio of indoor units to outdoor units is below 105%  
 -Minimum capacity of connecting indoor unit is more than 3HP  
 (\*9) : If the connected ratio of indoor units to outdoor units is more than 105%, set 15 m.

Drawings

Unit: mm

MMY-MUP0801HT8P-E, MMY-MUP1001HT8P-E  
MMY-MUP1201HT8P-E, MMY-MUP1401HT8P-E

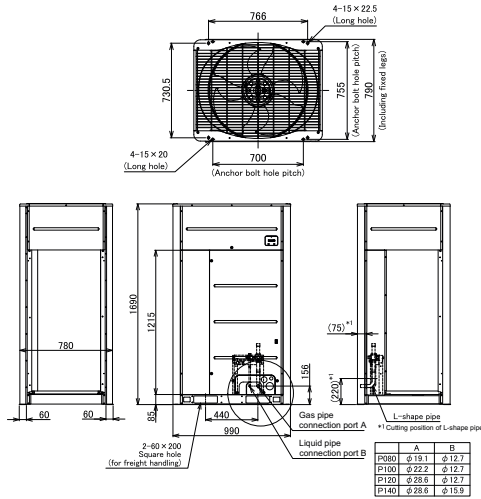

MMY-MUP1601HT8P-E, MMY-MUP1801HT8P-E, MMY-MUP2001HT8P-E,  
MMY-MUP2201HT8P-E, MMY-MUP2401HT8P-E

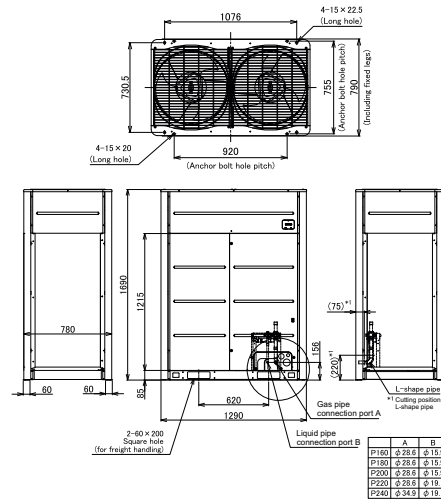

Sound pressure levels

Unit: dB(A)

MMY-MUP0801HT8P-E

Sound pressure Level (dB(A))	Cooling	Heating
	53.0	56.0

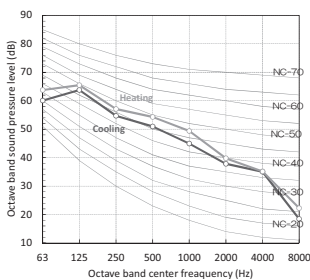

MMY-MUP1001HT8P-E

Sound pressure Level (dB(A))	Cooling	Heating
	55.0	58.0

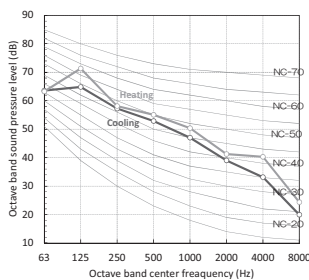

MMY-MUP1201HT8P-E

Sound pressure Level (dB(A))	Cooling	Heating
	58.0	62.0

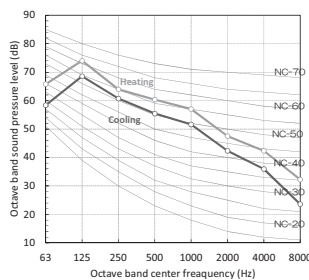

### Sound pressure levels

Unit: dB(A)

**MMY-MUP1401HT8P-E**

Sound pressure Level (dB(A))	Cooling	Heating
	58.0	62.0

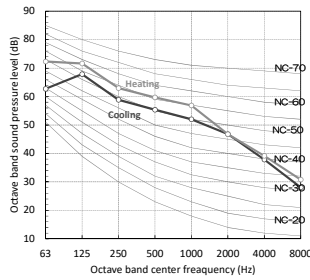

**MMY-MUP1601HT8P-E**

Sound pressure Level (dB(A))	Cooling	Heating
	60.0	63.0

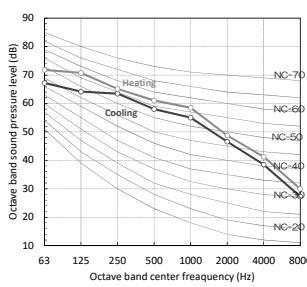

**MMY-MUP1801HT8P-E**

Sound pressure Level (dB(A))	Cooling	Heating
	61.0	67.0

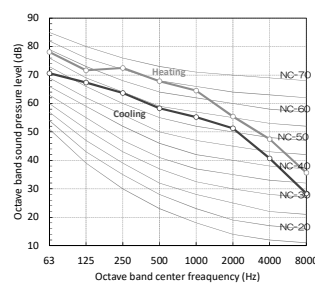

**MMY-MUP2001HT8P-E**

Sound pressure Level (dB(A))	Cooling	Heating
	63.0	67.0

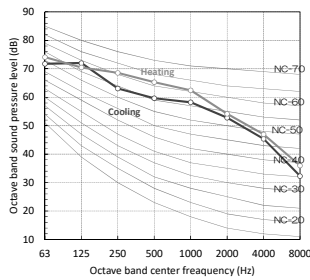

**MMY-MUP2201HT8P-E**

Sound pressure Level (dB(A))	Cooling	Heating
	63.0	67.0

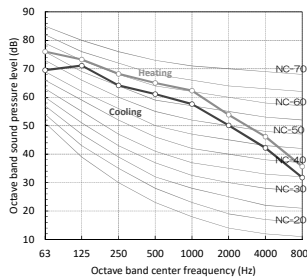

**MMY-MUP2401HT8P-E**

Sound pressure Level (dB(A))	Cooling	Heating
	63.0	67.0

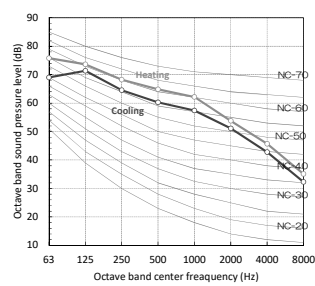

### Night mode sound pressure levels

Sound reduction and approximation capacity (reference)

type	"Night operation sound reduction dB (A)"	Capacity	
		Cooling	Heating
801	50	85%	80%
1001	50	70%	65%
1201	50	60%	55%
1401	53	70%	65%
1601	53	70%	70%
1801	54	65%	65%
2001	54	60%	60%
2201	54	55%	55%
2401	54	55%	55%

Condition : Cooling : (Indoor 27 deg DB, 19 deg WB) - (Outdoor temperature 25 deg DB)  
 Heating : (Indoor 20 deg DB) - (Outdoor temperature 7 deg DB, 6 deg WB)

### Accessories

	Name	Model name	Capacity	Appearance	Remarks
Branching joints and headers	Y-shape branching joint	RBM-BY55E	under 6.4hp		
		RBM-BY105E	from 6.4 to 14.2hp		
		RBM-BY205E	from 14.2 to 25.2hp		
		RBM-BY305E	from 25.2 to 61.2hp		
		RBM-BY405E	61.2hp or more		
	4-branching header	RBM-HY1043E	under 14.2hp		
		RBM-HY2043E	from 14.2 to 25.2hp		
8-branching header	RBM-HY1083E	under 14.2hp			
	RBM-HY2083E	from 14.2 to 25.2hp			
Branching joint for connection of outdoor units	RBM-BT14E	under 26hp			
	RBM-BT24E	from 26hp to 62hp			
	RBM-BT34E	62hp or more			
Optionnal PCB of outdoor unit	Power peak-cut control board	TCB-PCDM4E			Limit capacity of the VRF outdoor unit at 85%, 75%, 70% or 60% load or stop it. Dry contact
	External master ON/OFF control board	TCB-PCMO4E			Dry contact
	Output control board	TCB-PCIN4E			Operation output : The operation indicator is on while any indoor unit in the system is operating. Error output : The error indicator is on when an error is occurred on even one of the indoor or outdoor units in the system. Dry contact



CAPACITY

OPERATION



8HP > 60HP

-25°C > +46°C

Toshiba all inverter VRF system has continued to evolve and includes many intelligent and innovative features that maximise end user comfort and system efficiencies.

Features

Outdoor unit	CO	MMY-	MAP0806T8P-E	MAP1006T8P-E	MAP1206T8P-E	MAP1406T8P-E	MAP1606T8P-E	MAP1806T8P-E	MAP2006T8P-E	MAP2206T8P-E	
Outdoor unit	HP	MMY-	MAP0806HT8P-E	MAP1006HT8P-E	MAP1206HT8P-E	MAP1406HT8P-E	MAP1606HT8P-E	MAP1806HT8P-E	MAP2006HT8P-E	MAP2206HT8P-E	
Capacity range	HP		8	10	12	14	16	18	20	22	
Cooling capacity	kW		22,4	28,0	33,5	40,0	45,0	50,4	56,0	61,5	
Heating capacity +7°C	kW		25,0	31,5	37,5	45,0	50,0	56,0	63,0	64,0	
Heating capacity -7°C	kW		19,8	24,2	27,9	34,6	37,2	43,1	46,9	47,6	
Power supply	V-ph-Hz		380/415-3-50	380/415-3-50	380/415-3-50	380/415-3-50	380/415-3-50	380/415-3-50	380/415-3-50	380/415-3-50	
Efficiency	EER rated	W/W	4.04	3.64	3.35	3.25	3.15	3.45	3.24	2.65	
	EER 50% load	W/W	6,4	6,22	5,84	5,7	5,64	5,5	5,37	5,34	
	SEER	η/std	237.1%/6.11	235.1%/6.06	230.9%/5.95	218.4%/5.63	205.2%/5.29	231.2%/5.96	220.8%/5.69	195.5/5.04	
Efficiency	COP rated	W/W	4.52	4.25	3.89	4.02	3.88	3.97	3.71	3.74	
	COP 50% load	W/W	6.44	6.01	5.43	5.77	5.55	5.41	5.05	5.07	
	COP -7°C 100% load	W/W	3.66	3.40	3.06	3.23	3.05	3.19	2.91	2.94	
	SCOP	η/std	141.2%/3.64	137%/3.53	146.8%/3.66	138.5%/3.57	143.5%/3.7	139.3%/3.59	139.3%/3.59	138.5%/3.57	
Electrical characteristics	Running current	A	C	8,8	12.1	15.5	19.5	22.4	22.9	26.8	35.6
	Power input	kW	C	5.54	7.69	10.00	12.30	14.30	14.60	17.30	23.20
	Running current	A	H	8,8	11.6	15.0	17.8	20.2	22.1	26.1	26.5
	Power input	kW	H	5.53	7.41	9.65	11.20	12.90	14.10	17.00	17.10
Dimensions (h x w x d)	mm		1830 x 990 x 780	1830 x 990 x 780	1830 x 990 x 780	1830 x 1210 x 780	1830 x 1210 x 780	1830 x 1600 x 780	1830 x 1600 x 780	1830 x 1600 x 780	
Weight	kg	CO/HP		241/242			299/300		370/371		
Compressor	Type						Hermetic Twin Rotary				
	Motor output	kW		2.1x2	3.1x2	3.9x2	4.8x2	5.8x2	6.5x2	7.6x2	9x2
Fan unit	Type						Propeller fan				
	Motor output	W		1	1	1	1	1	2	2	2
	Air volume	m³/h		9700		12200		12600	17300	17900	18500
External static pressure available	Pa		60	60	50	50	40	50	40	40	
R410A refrigerant charge	kg	HP/CO	11.5/10.5	11.5/10.5	11.5/10.5	11.5/11.5	11.5/11.5	11.5/11.5	11.5/11.5	11.5/11.5	
	CO <sub>2</sub> Teq	HP/CO	24/21.9	24/21.9	24/21.9	24/24	24/24	24/24	24/24	24/24	
Power supply wiring	MCA	A	20.5	21.5	36.1	31	35.8	40.6	44.9	49.3	
	MCOP	A		25	32		40	50		63	
Pipe connection	Gas line type - Diameter		Brazed - 3/4"	Brazed - 7/8"	Brazed - 1-1/8"	Brazed - 1-1/8"	Brazed - 1-1/8"	Brazed - 1-1/8"	Brazed - 1-1/8"	Brazed - 1-1/8"	
	Liquid line type - Diameter		Flare - 1/2"	Flare - 1/2"	Flare - 1/2"	Flare - 5/8"	Flare - 5/8"	Flare - 5/8"	Flare - 5/8"	Flare - 3/4"	
	Balance diameter		Flare - 3/8"	Flare - 3/8"	Flare - 3/8"	Flare - 3/8"	Flare - 3/8"	Flare - 3/8"	Flare - 3/8"	Flare - 3/8"	
Max. number of connected indoor units			18	22	27	31	36	40	45	49	
Sound pressure level	Cooling	dB(A)	C	55	57	59	60	62	60	61	61
	Heating	dB(A)	H	56	58	61	62	64	61	62	62
Sound power level	Cooling	dB(A)	C	74	74	80	80	81	81	82	83
	Heating	dB(A)	H	74	74	82	82	83	83	84	84
Operation temperature range	Cooling	CDB	C				-10/46				
	Heating	CWB	H				-25/15.5				

Installation space

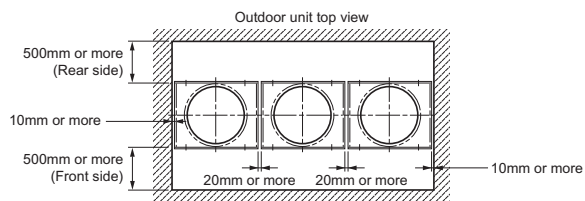
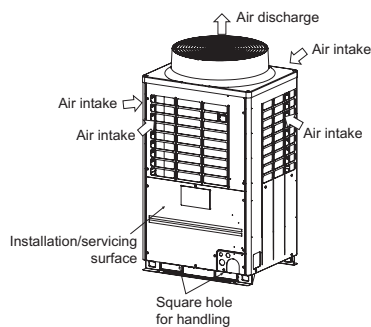

Leave space necessary for running, installation and servicing.

- If there is an obstacle above the outdoor unit, leave a space of 2000 mm or more to the top end of the outdoor unit.
- If there is a wall around the outdoor unit, make sure that its height does not exceed 800 mm.

Also applicable for SMMS-e stand alone and SHRME

**Capacity table - Standard model**

HP	Capacity		Combination	Modèle	EER/SEER	COP/SCOP	Max indoor connectivity	
	Cooling/Heating in kW							
8	22.4/25		8	MMY-MAP0806HT8P-E	4.04/6.11	4.52/3.64	18	
10	28/31.5		10	MMY-MAP1006HT8P-E	3.64/6.06	4.25/3.53	22	
12	33.5/37.5		12	MMY-MAP1206HT8P-E	3.35/5.95	3.89/3.66	27	
14	38.4/45		14	MMY-MAP1406HT8P-E	3.25/5.63	4.02/3.57	31	
16	45/50		16	MMY-MAP1606HT8P-E	3.15/5.29	3.88/3.7	36	
18	50.4/56		18	MMY-MAP1806HT8P-E	3.45/5.96	3.97/3.59	40	
20	56/62		20	MMY-MAP2006HT8P-E	3.24/5.69	3.71/3.59	45	
22	61.5/63		22	MMY-MAP2206HT8P-E	2.65/5.04	3.74/3.57	49	
24	67/75		12 + 12	MMY-AP2416HT8P-E	3.35/5.95	3.88/3.66	52	
26	73.5/82.5		14 + 12	MMY-AP2616HT8P-E	3.3/5.79	3.97/3.61	58	
28	78.5/87.5		16 + 12	MMY-AP2816HT8P-E	3.23/5.59	3.89/3.69	63	
30	85/95		16 + 14	MMY-AP3016HT8P-E	3.19/5.45	3.94/3.64	64	
32	90/100		16 + 16	MMY-AP3216HT8P-E	3.15/5.29	3.88/3.7	64	
34	95.4/106		18 + 16	MMY-AP3416HT8P-E	3.3/5.64	3.93/3.64	64	
36	101/113		20 + 16	MMY-AP3616HT8P-E	3.2/5.51	3.78/3.64	64	
38	106.5/114		22 + 16	MMY-AP3816HT8P-E	2.84/5.17	3.8/3.63	64	
40	112/126		20 + 20	MMY-AP4016HT8P-E	3.24/5.69	3.71/3.59	64	
42	117.5/127		22 + 20	MMY-AP4216HT8P-E	2.9/5.37	3.72/3.59	64	
44	123/128		22 + 22	MMY-AP4416HT8P-E	2.65/5.04	3.74/3.57	64	
46	130/145		16 + 16 + 14	MMY-AP4616HT8P-E	3.18/5.39	3.92/3.66	64	
48	135/150		16 + 16 + 16	MMY-AP4816HT8P-E	3.15/5.29	3.88/3.7	64	
50	140.4/156		18 + 16 + 16	MMY-AP5016HT8P-E	3.25/5.53	3.91/3.66	64	
52	146/163		20 + 16 + 16	MMY-AP5216HT8P-E	3.18/5.44	3.81/3.66	64	
54	151.5/164		22 + 16 + 16	MMY-AP5416HT8P-E	2.92/5.2	3.82/3.65	64	
56	157/176		20 + 20 + 16	MMY-AP5616HT8P-E	3.21/5.58	3.75/3.62	64	
58	162.5/177		22 + 20 + 16	MMY-AP5816HT8P-E	2.97/5.35	3.77/3.62	64	
60	168/178		22 + 22 + 16	MMY-AP6016HT8P-E	2.77/5.13	3.78/3.61	64	

**Capacity table - High efficiency & high capacity model**

HP	Capacity		Combination	Modèle	EER/SEER	COP/SCOP	Max indoor connectivity	
	Cooling/Heating in kW							
20 HP	56/63		10 + 10	MMY-AP2026HT8P-E	3.63/6.06	4.26/3.53	45	
22 HP	61.5/69		12 + 10	MMY-AP2226HT8P-E	3.47/6.02	4.04/3.61	49	
36 HP	100.5/112.5		12 + 12 + 12	MMY-AP3626HT8P-E	3.35/5.95	3.89/3.66	64	
38 HP	107/120		14 + 12 + 12	MMY-AP3826HT8P-E	3.31/5.84	3.93/3.63	64	
40 HP	113.5/127.5		14 + 14 + 12	MMY-AP4026HT8P-E	3.28/5.73	3.98/3.6	64	
42 HP	120/135		14 + 14 + 14	MMY-AP4226HT8P-E	3.25/5.63	4.01/3.57	64	
44 HP	125/140		16 + 14 + 14	MMY-AP4426HT8P-E	3.21/5.51	3.97/3.62	64	
54 HP	152/171		20 + 20 + 14	MMY-AP5426HT8P-E	3.24/5.69	3.78/3.59	64	



Piping rules

		Allowable value		Piping section
Piping length	Total extension of pipe (Liquid pipe, real length)	Below 34HP	300m	LA + LB + La + Lb + Lc + L1 + L2 + L3 + L4 + L5 + L6 + L7 + a + b + c + d + e + f + g + h + i + j
		34HP or more	1000m	
	Farthest piping length	Equivalent length	235m	LA + L1 + L3 + L4 + L5 + L6 + j
		Real length	190m	
	Equivalent length of farthest piping form 1st branching		90m	L3 + L4 + L5 + L6 + j
	Equivalent length of farthest piping between outdoor units		25m	LA + Lc (LA + Lb)
	Max. equivalent length of main piping	Equivalent length	120m	L1
		Real length	100m	
Max. equivalent length of outdoor unit connecting piping		10m	mLc (La, Lb)	
Max. real length of indoor unit connecting piping		30m	a, b, c, d, e, f, g, h, i, j	
Max. equivalent length between branches		50m	L2, L3, L4, L5, L6, L7	
Difference in height	Height between indoor and outdoor units	Upper outdoor unit	70m	
		Lower outdoor unit	40m	
	Height between indoor units		40m	
	Height between outdoor units		5m	

- (\*1) : (D) is outdoor unit farthest from the 1st branch and (J) is the indoor unit farthest from the 1st branch.
- (\*2) : If the height difference (H1) between indoor and outdoor unit exceeds 3 m, set 65 m or less.
- (\*3) : If the max. combined outdoor unit capacity is 54HP or more, then max. equivalent length is 70 m or less (real length is 50 m or less).
- (\*4) : If the height difference (H2) between indoor units exceeds 3 m, set 50 m or less.
- (\*5) : If the height difference (H2) between indoor units exceeds 3 m, set 30 m or less
- (\*6) : Total charging refrigerant is 140 kg or less.
- (\*7) : Extension up till 90 m is possible with conditions below

- Outdoor temperature tooling: 10 - 46 (DB)
- Heating: -5 - 15.5 (WB)
- Equivalent length of farthest piping from 1st branching Li < 50 m
- Real length of main piping L1 < 100 m
- Height difference between indoor units H2 < 3 m
- Total capacity of combined indoor units: 90% - 105%
- Single CDU, and up to 20HP
- Minimum capacity of connectable indoor: unit 4HP or larger

Drawings

Unit: mm

MMY-MAP0806HT8P-E  
MMY-MAP1006HT8P-E  
MMY-MAP1206HT8P-E

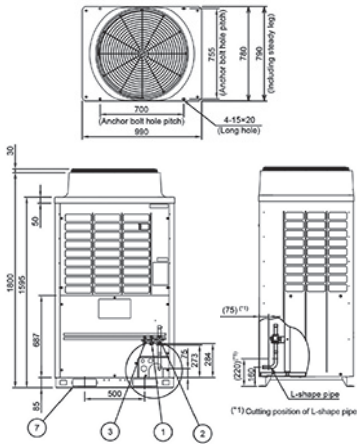

MMY-MAP1406HT8P-E  
MMY-MAP1606HT8P-E

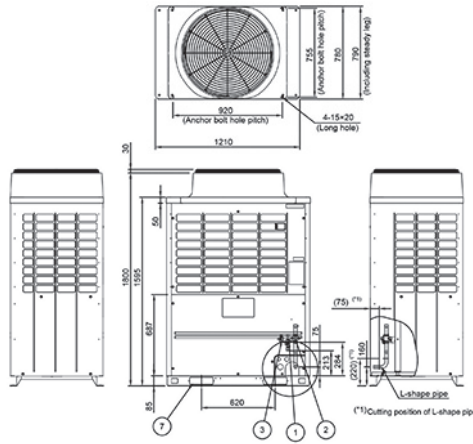

MMY-MAP1806HT8P-E  
MMY-MAP2006HT8P-E  
MMY-MAP2206HT8P-E

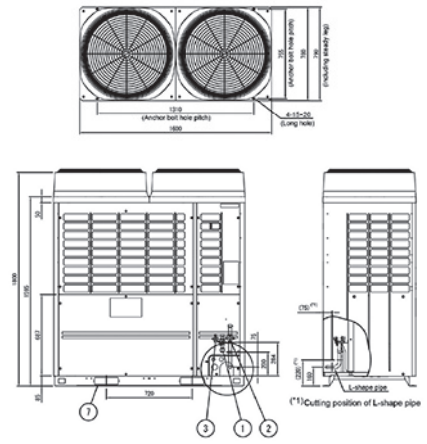

Sound pressure levels

Unit: dB(A)

MMY-MAP0806HT8P-E

Sound pressure Level (dB(A))	Cooling	Heating
	55.0	56.0

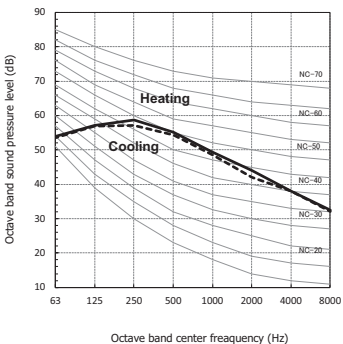

MMY-PAP1006HT8P-E

Sound pressure Level (dB(A))	Cooling	Heating
	57.0	58.0

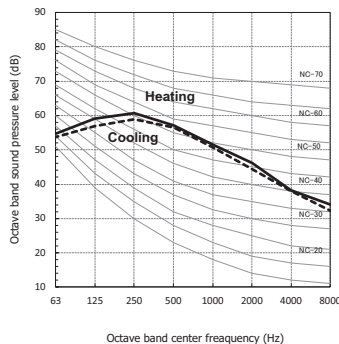

MMY-MAP1206HT8P-E

Sound pressure Level (dB(A))	Cooling	Heating
	59.0	61.0

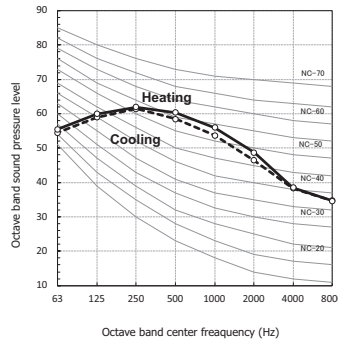

MMY-MAP1406HT8P-E

Sound pressure Level (dB(A))	Cooling	Heating
	60.0	62.0

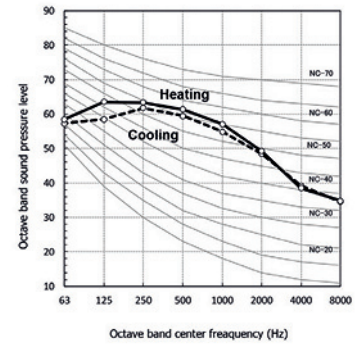



Sound pressure levels

Unit: dB(A)

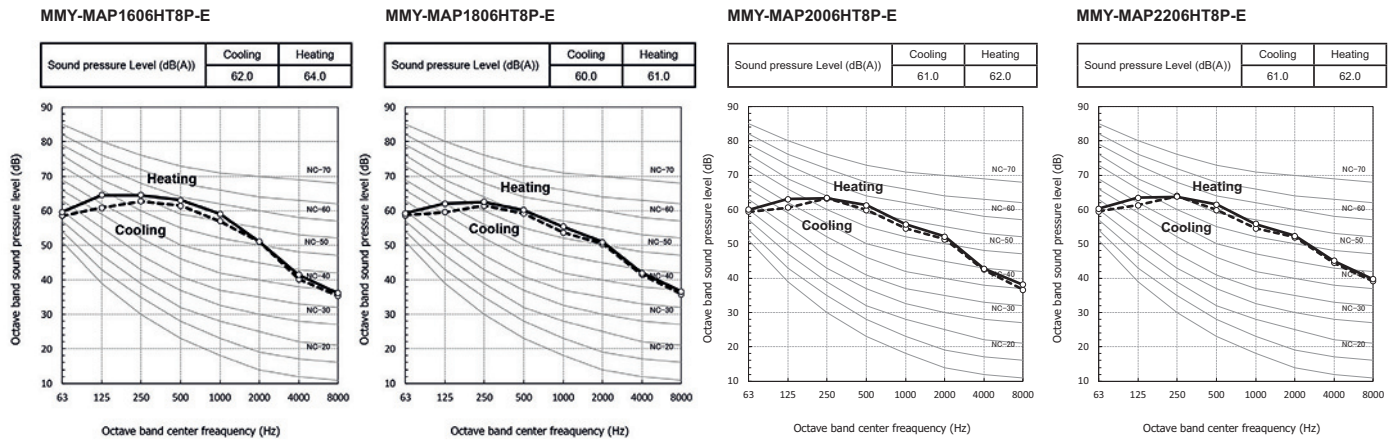

Night mode sound pressure levels

Sound reduction and capacity approximation (Reference)

Type	Night operation sound reduction dB (A)	Capacity	
		Cooling	Heating
0806	50	Approx. 85%	Approx. 80%
1006	50	Approx. 70%	Approx. 65%
1206	50	Approx. 60%	Approx. 55%
1406	53	Approx. 80%	Approx. 80%
1606	53	Approx. 70%	Approx. 70%
1806	54	Approx. 65%	Approx. 65%
2006	54	Approx. 60%	Approx. 60%
2206	54	Approx. 55%	Approx. 55%

Accessories

Name	Model name	Capacity	Appearance	Remarks	
Branching joints and headers	Y-shape branching joint	RBM-BY55E	Under 6.4hp		
		RBM-BY105E	From 6.4 to 14.2hp		
		RBM-BY205E	From 14.2 to 25.2hp		
		RBM-BY305E	25.2hp or more		
	4-branching header	RBM-HY1043E	Under 14.2hp		
		RBM-HY2043E	From 14.2 to 25.2hp		
RBM-HY1083E		Under 14.2hp			
8-branching header	RBM-HY2083E	From 14.2 to 25.2hp			
	RBM-BT14E	Under 26hp			
Branching joint for connection of outdoor units	RBM-BT24E	26hp or more			
Optional PCB of outdoor unit	Power peak-cut control board	TCB-PCDM4E		Limit capacity of the VRF outdoor unit at 85%, 75%, 70% or 60% load or stop it. Dry contact	
	External master ON/OFF control board	TCB-PCMO4E		Dry contact	
	Output control board	TCB-PCIN4E		Operation output: The operation indicator is on while any indoor unit in the system is operating. Error output: The error indicator is on when an error is occurred on even one of the indoor or outdoor units in the system. Dry contact	

MMY-MAP\_FT8P  
SHRM-e



CAPACITY OPERATION



8HP > 54HP

-25°C > +46°C

The SHRM-e, full Inverter heat recovery 3-pipe VRF, is the ultimate simultaneous heating & cooling solution for business applications.

Features

Outdoor unit		MMY-	MAP0806FT8P-E	MAP1006FT8P-E	MAP1206FT8P-E	MAP1406FT8P-E	MAP1606FT8P-E	MAP1806FT8P-E	MAP2006FT8P-E	
Capacity range	HP		8	10	12	14	16	18	20	
Cooling capacity <sup>1</sup>	Rated	kW	22.4	28.0	33.5	40.0	45.0	50.4	56.0	
	Max	kW	22.4	28.0	33.5	40.0	45.0	50.4	56.0	
Heating capacity <sup>2</sup>	Rated	kW	25.0	31.5	37.5	45.0	50.0	56.5	63.0	
	Max	kW	25.0	31.5	37.5	45.0	50.0	56.5	63.0	
Power supply	V-ph-Hz		380/415-3-50	380/415-3-50	380/415-3-50	380/415-3-50	380/415-3-50	380/415-3-50	380/415-3-50	
Efficiency	EER rated	W/W	3.76	3.51	3.43	3.14	3.23	3.15	3.01	
	EER 50% load	W/W	7.32	7.035	6.162	5.666	6.233	6.79	5.091	
	SEER	η/std	239.8%/6.07	238.2%/6.03	234.6%/5.94	221.4%/5.61	225.8%/5.72	232.6%/5.89	222.6%/5.64	
Efficiency	COP rated	W/W	4.15	3.97	3.85	3.81	3.69	3.67	3.52	
	COP 50% load	W/W	5.92	5.60	5.38	5.48	5.28	5.02	4.79	
	COP -7°C 100% load	W/W	3.35	3.20	3.03	3.05	2.91	2.96	2.77	
	SCOP	η/std	142.6%/3.64	138.2%/3.53	145.4%/3.71	139.8%/3.57	137%/3.50	140.6%/3.59	140.6%/3.59	
Electrical characteristic	Running current	A	C	9.4	12.5	15.5	19.9	21.8	25.1	29.2
	Power input	kW	C	5.95	7.98	9.77	12.74	13.93	16.00	18.60
	Running current	A	H	8.6	11.1	13.8	16.5	19.1	21.5	24.7
	Power input	kW	H	5.40	7.05	8.70	10.50	12.20	13.73	15.91
Dimensions (h x w x d)	mm		1830 x 990 x 780	1830 x 990 x 780	1830 x 1210 x 780	1830 x 1210 x 780	1830 x 1600 x 780	1830 x 1600 x 780	1830 x 1600 x 780	
Weight	kg		263			316		377		
Compressor	Type		Hermetic Twin Rotary							
	Motor output	kW	2.3x2	3.1x2	3.9x2	4.8x2	5.8x2	6.5x2	7.6x2	
Fan unit	Type		Propeller fan							
	Motor output	W	1	1	1	1	2	2	2	
	Air volume	m <sup>3</sup> /h	9700		12200		17300		17900	
External static pressure available	Pa		60	60	50	40	40	40	40	
R410A refrigerant charge	kg/CO <sub>2</sub> Eq		11/23	11/23	11/23	11/23	11/23	11/23	11/23	
Power supply wiring	MCA	A	21.5	26.1	31	35.8	40.6	44.9	49.3	
	MCOP	A	25.0	32.0	40.0	50.0	50.0	50.0	63.0	
Pipe connection	Suction line type - Diameter		Brazed - 7/8"	Brazed - 7/8"	Brazed - 1-1/8"	Brazed - 1-1/8"	Brazed - 1-1/8"	Brazed - 1-1/8"	Brazed - 1-1/8"	
	Discharge line type - Diameter		Brazed - 3/4"	Brazed - 3/4"	Brazed - 3/4"	Brazed - 7/8"	Brazed - 7/8"	Brazed - 7/8"	Brazed - 7/8"	
	Liquid line type - Diameter		Flare - 1/2" or 3/8"	Flare - 1/2" or 3/8"	Flare - 1/2" or 3/8"	Flare - 5/8" or 1/2"	Flare - 3/4" or 1/2"	Flare - 3/4" or 5/8"	Flare - 3/4" or 5/8"	
	Balance diameter		Flare - 3/8"	Flare - 3/8"	Flare - 3/8"	Flare - 3/8"	Flare - 3/8"	Flare - 3/8"	Flare - 3/8"	
Connectivity	Max. number of connected indoor units		18	22	27	31	36	40	41	
	Diversity ratio	Min/Max	50/135%							
Sound pressure level	Cooling	dB(A)	C	59	59	60	62	61	61	61
	Heating	dB(A)	H	61	61	62	64	62	62	62
Sound power level	Cooling	dB(A)	C	80	80	80	81	83	83	83
	Heating	dB(A)	H	82	82	82	83	84	84	84
Operation temperature range	Cooling	CDB	C	-10/46						
	Heating	CWB	H	-25/15.5						

C = Cooling mode  
H = Heating mode  
Reduced liquid pipe size can be used for the less local refrigerant charge saving case.  
- Refrigerant saving case will cause the following conditions.

\* Real length of main piping (L1) varies 15m - 50m by outdoor units capacity.  
\* Height difference between outdoor to indoor units(H1) is 30m or less

Installation flexibility



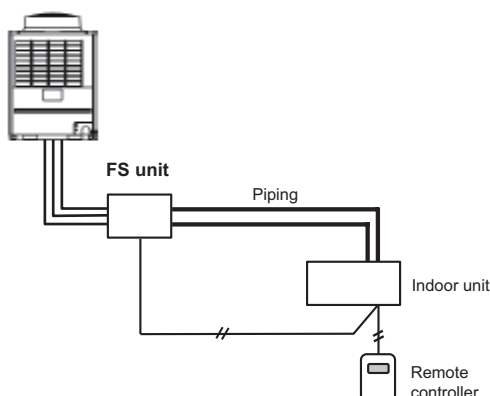



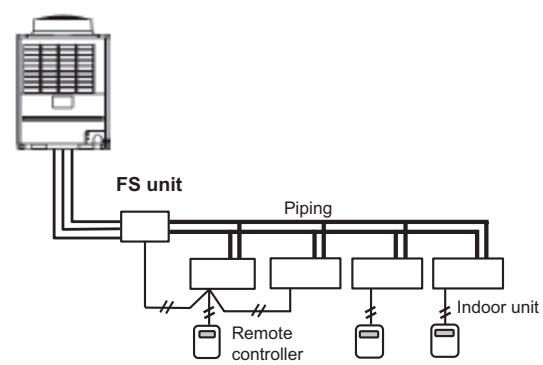







< In case of connecting one indoor unit >



< In case of connecting one group operation of indoor units and two indoor units >



**Capacity table - Standard model**

Capacity	Combination	Modèle	Cooling capacity	Heating capacity	EER	SEER	COP	SCOP	Max indoor connectivity	
8 HP	8	MMY-MAP0806FT8P-E	22,4	25	3,76	6,07	4,14	3,64	18	
10 HP	10	MMY-MAP1006FT8P-E	28	31,5	3,51	6,03	3,97	3,53	22	
12 HP	12	MMY-MAP1206FT8P-E	33,5	37,5	3,43	5,94	3,85	3,71	27	
14 HP	14	MMY-MAP1406FT8P-E	40	45	3,14	5,61	3,8	3,57	31	
16 HP	16	MMY-MAP1606FT8P-E	45	50	3,26	5,72	3,68	3,5	36	
18 HP	18	MMY-MAP1806FT8P-E	50,4	56,5	3,15	5,89	3,67	3,59	40	
20 HP	20	MMY-MAP2006FT8P-E	56	58	3,01	5,64	6,52	3,59	41	
22 HP	12 + 10	MMY-AP2216FT8P-E	61,5	69	3,47	5,99	3,9	3,63	49	
24 HP	14 + 10	MMY-AP2416FT8P-E	68	76,5	3,29	5,81	3,8	3,56	51	
26 HP	14 + 12	MMY-AP2616FT8P-E	73,5	82,5	3,27	5,77	3,83	3,63	58	
28 HP	14 + 14	MMY-AP2816FT8P-E	80	90	3,15	5,61	3,81	3,57	63	
30 HP	16 + 14	MMY-AP3016FT8P-E	85	95	3,2	5,67	3,74	3,54	64	
32 HP	18 + 14	MMY-AP3216FT8P-E	90,4	101,5	3,15	5,77	3,1	3,58	64	
34 HP	18 + 16	MMY-AP3416FT8P-E	95,4	106,5	3,19	5,81	3,68	3,55	64	
36 HP	18 + 18	MMY-AP3616FT8P-E	100,8	113	3,15	5,89	3,68	3,59	64	
38 HP	20 + 18	MMY-AP3816FT8P-E	106,4	114,5	3,08	5,76	3,59	3,59	64	
40 HP	20 + 20	MMY-AP4016FT8P-E	112	116	3,01	5,64	3,52	3,59	64	
42 HP	14 + 14 + 14	MMY-AP4216FT8P-E	120	135	3,15	5,61	3,81	3,57	64	
44 HP	16 + 14 + 14	MMY-AP4416FT8P-E	125	140	3,18	5,65	3,77	3,55	64	
46 HP	18 + 14 + 14	MMY-AP4616FT8P-E	130,4	146,5	3,15	5,72	3,76	3,58	64	
48 HP	18 + 16 + 14	MMY-AP4816FT8P-E	135,4	151,5	3,25	5,77	3,7	3,56	64	
50 HP	18 + 18 + 14	MMY-AP5016FT8P-E	140,8	158	3,21	5,83	3,7	3,59	64	
52 HP	18 + 18 + 16	MMY-AP5216FT8P-E	145,8	163	3,18	5,84	3,68	3,56	64	
54 HP	18 + 18 + 18	MMY-AP5416FT8P-E	152,1	169,5	3,15	5,89	3,68	3,59	64	

CDU



Piping rules

		Allowable value	Piping section		
Piping length	Total extension of pipe (Liquid pipe, real length)	Below 34HP	300m		
		34HP or more	1000m (*9)		
	Farthest piping length (*1) (*3)	Equivalent length	200m (*2)	LA + Lc + L1 + L3 + L4 + L5 + L6 + L7 + L8 + L9 + a + b + c + d + e + f + g + h + i + j + k + l + m + n + o + p + q + r + s + t + u	
		Real length	180m		
	Equivalent length of farthest piping from 1st branching (*1)	Height difference between IDU >3 m	50m	L3 + L4 + L5 + L6 + L7 + L8 + o	
		Height difference between IDU 3 m	65m		
	Equivalent length of farthest piping between outdoor units (*1)		15m	LA + Lc (LA + Lb)	
	Max equivalent/real length of main piping (*12)		Height difference between IDU <3 m	100/85m	L1
			Height difference between IDU >3 m	120/100m	
	Max. equivalent length of outdoor unit connecting piping			10m	Lc (La, Lb)
Max. real length of indoor unit connecting piping			30m	a + f, a + g, c + h, d + i, e + j, k, l	
Max. equivalent length between branches			50m	L2, L3, L4, L8, L9	
Maximum real length of terminal branching section to indoor units		Single port type	15m	f, g, h, i, j	
		Multi port type	50m (*10) (*11)	p, q, r, s + t, s + u	
Difference in height	Height between indoor and outdoor units (*7)	Upper outdoor unit	70m (*8) (*13)		
		Lower outdoor unit	30m (*6)		
	Height between indoor units (*7)	Upper outdoor unit	40m		
		Lower outdoor unit (*4)	15m		
Height between outdoor units (*5)			5m		
In case of 4 series flow selector connection to indoor units	Maximum equivalent length indoor units in group control by one single port flow selector unit		30m	L6 + L7 + L8 + o	
	Maximum real length between flow selector unit and indoor unit (*2)		Single port type	15m	L7 + m 15m or L7 + L8 + n 15 m
			Multi port type	50m	s + t, s + u 50m
	Height difference between indoor units in group control by one flow selector unit			0.5m	

- (\*1) : Farthest outdoor unit from the first branch: (C), farthest indoor unit: (o)
- (\*2) : When connecting the multiple indoor units to the single port type flow selector unit, wire the indoor unit to the remote controller to the single port type flow selection unit.
- (\*3) : Allowable values for length equivalent to furthest pipe are shown below and they vary according to performance rank of outdoor unit. 22.4 to 56.0: 180 m, 61.5 to 112: 195 m, 120: 200 m.
- (\*4) : When system capacity is greater than 28 HP, height difference between indoor units is limited to 3 m. If the piping exceeds 3 m with a capacity greater than 28 HP there may be a case of capacity shortage in cooling.
- (\*5) : Ensure that the header unit is installed below all connected follower outdoor unit(s). Possible product failure may occur if header unit is installed above any follower unit(s).
- (\*6) : 40 m is possible for a system that uses only the flow selector unit (multi port type), whose all the indoor units are 3HP or higher, and working ambient temperature is 0 °C or higher.
- (\*7) : As for 44HP to 54HP contact our agent.
- (\*8) : If the height difference (H2) between indoor units exceed 3 m, set 50 m or less.
- (\*9) : Total charging refrigerant is 140 kg or less.
- (\*10) : The total piping length in one FS unit in case of branching to 4: 120 m (p + q + r + s + t + u). In case of branching to 6: 180 m.

- (\*11) : Length of whole pipe should be shorter than 50 m in one branch.
- (\*12) : As for 42HP to 54HP contact our agent.
- (\*13) : Extension up till 90 m is possible with conditions below
  - Outdoor temperature cooling operation: 10 - 46 (DB)
  - Heating operation: -5 - 15.5 (WB)
  - Simultaneous operation: 7 - 25 (DB)
  - Equivalent length of farthest piping from 1st branching Li < 50 m
  - Real length of main piping L1 < 50 m
  - Height difference between indoor units H2 < 3 m
  - Height difference between FS units < 0.5 m
  - Total capacity of connectable indoor units: 90% - 100%
  - Single CDU, and up to 18HP
  - Minimum capacity of connectable indoor: unit 4HP or larger.

Drawings

Unit: mm

MMY-MAP0806FT8P-E  
MMY-MAP1006FT8P-E

MMY-MAP1206FT8P-E  
MMY-MAP1406FT8P-E

MMY-MAP1606FT8P-E  
MMY-MAP1806FT8P-E  
MMY-MAP2006FT8P-E

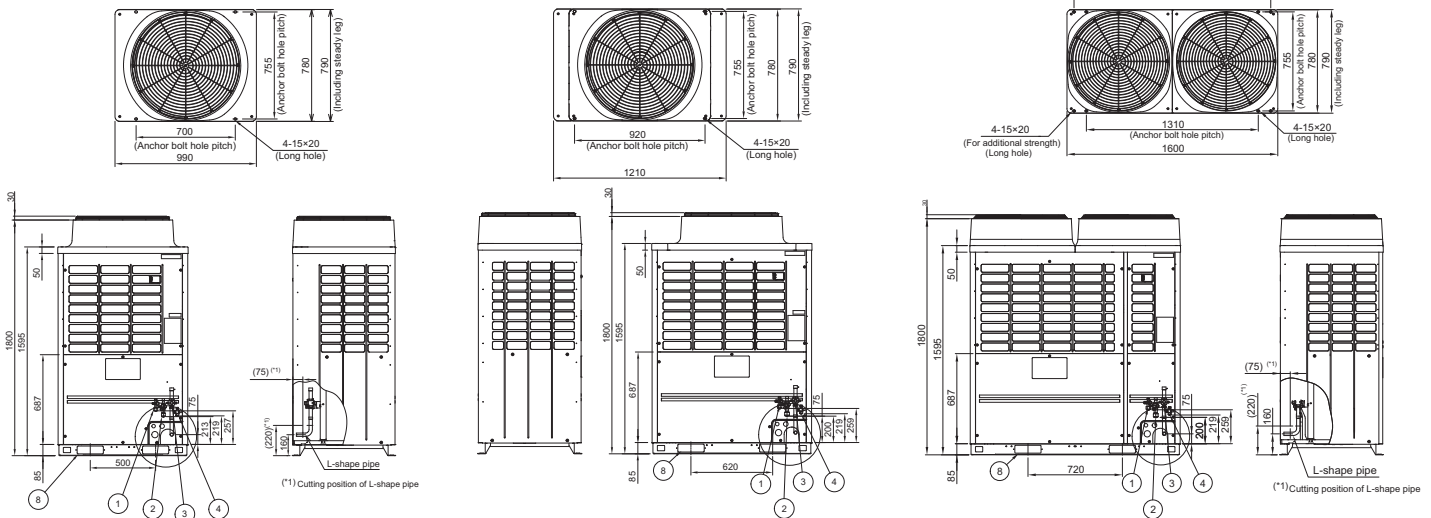

Sound pressure levels

Unit: dB(A)

MMY-MAP0806FT8P-E

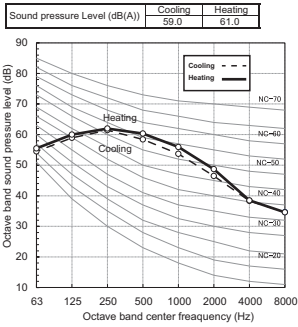

MMY-MAP1006FT8P-E

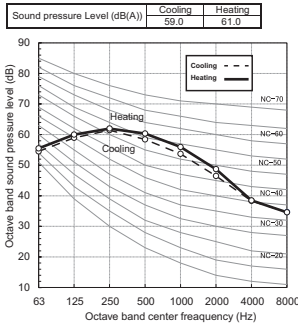

MMY-MAP1206FT8P-E

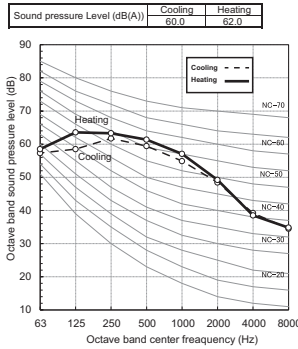

MMY-MAP1406FT8P-E

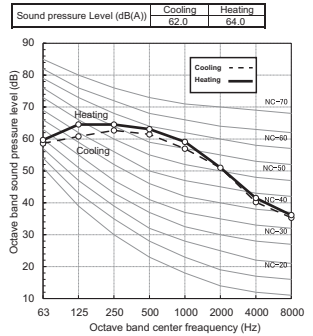

MMY-MAP1606FT8P-E

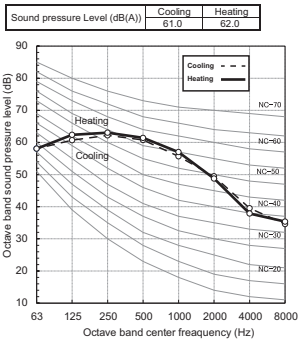

MMY-MAP1806FT8P-E

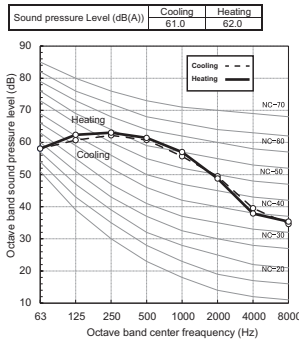

MMY-MAP2006FT8P-E

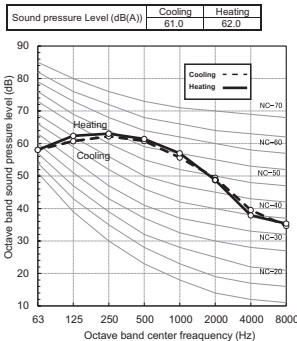

Night mode sound pressure level

Sound reduction and approximation capacity (reference)

Type	Night operation sound reduction dB (A)	Capacity	
		Cooling	Heating
0806	50	Approx. 85%	Approx. 85%
1006	50	Approx. 70%	Approx. 70%
1206	53	Approx. 80%	Approx. 80%
1406	53	Approx. 70%	Approx. 70%
1606	54	Approx. 65%	Approx. 65%
1806	54	Approx. 60%	Approx. 60%
2006	54	Approx. 55%	Approx. 55%

Accessories

	Name	Model name	Capacity	Appearance	Dimensions (mm)	Remarks
Branching joints and headers	Y-shape branching joint	RBM-BY55FE	Under 6.4hp			
		RBM-BY105FE	From 6.4 to 14.2hp			
		RBM-BY205FE	From 14.2 to 25.2hp			
		RBM-BY305FE	25.2hp or more			
	4-branching header	RBM-HY1043FE	Under 14.2hp			
		RBM-HY2043FE	From 14.2 to 25.2hp			
8-branching header	RBM-HY1083FE	Under 14.2hp				
	RBM-HY2083FE	From 14.2 to 25.2hp				
Branching joint for connection of outdoor units	RBM-BT14E	Under 26hp				
	RBM-BT24E	26hp or more				
Flow selector	3 series single output FS Box (Powered by IDUs)	RBM-Y1123FE	Under 4hp		190x320x160	1 output - From 1 to 5 IDU per output
		RBM-Y1803FE	From 4 to 6.4hp		200x470x200	1 output - From 1 to 8 IDU per output
		RBM-Y2803FE	From 6.4 to 10hp			1 output - From 1 to 8 IDU per output
	4 series single output FS Box (Up to 50m piping length from FS box to IDU)	RBM-Y1124FE	Under 4hp		180x425x300	1 output - From 1 to 6 IDU per output
		RBM-Y1804FE	From 4 to 6.4hp		180x425x350	1 output - From 1 to 10 IDU per output
		RBM-Y2804FE	From 6.4 to 10hp			1 output - From 1 to 16 IDU per output
	Multiple output	RBM-Y1801F4PE	Up to 6hp per output		215x730x567	4 outputs - From 1 to 10 IDU per output
RBM-Y1801F6PE		Up to 6hp per output	215x1050x567		6 outputs - From 1 to 10 IDU per output	
Connection accessory	RBC-CBK15FE				15m Bus cable for 3 serie FS box	
Optional PCB of outdoor unit	Power peak-cut control board	TCB-PCDM4E				limit capacity of the VRF outdoor unit at 85%, 75%, 70% or 60% load or stop it. Dry contact
	External master ON/OFF control board	TCB-PCMO4E				Dry contact
	Output control board	TCB-PCIN4E				Operation output: The operation indicator is on while any indoor unit in the system is operating. Error output: The error indicator is on when an error has occurred on even one of the indoor or outdoor units in the system. Dry contact

# WIDE CHOICE INDOOR UNITS



## > LARGE INDOOR UNIT LINE-UP

The wide choice of indoor unit models increases design flexibility and reduces costs to the building's owner by ensuring the most appropriate system is installed.

- 17 different types of indoor units
- Capacity from 0.3 hp to 14 hp
- For heating, cooling, fresh air and hot water production



## > SUPERIOR AIR COMFORT

### Optimised heating operations

The Toshiba VRF allow continuous heating, even during external defrost operations, thanks to the Kobetsu and Renkei function integrated in SMMS-u. Indoor units will now operate continually, with only a minimal reduction in capacity output. This results in an uninterrupted flow of warm air, ensuring maximum comfort to the end user.



### Dual set point for more precision

The Dual Set Point increases the system's energy efficiency and reduces overall running costs, with longer periods of time in thermal off mode. Heating and cooling temperatures at which the indoor unit will begin to operate can now be individually selected giving maximum flexibility to the user.

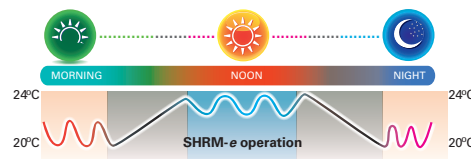

### Cool comfort with soft cooling mode

The development of the soft cooling mode provides a new level for cool comfort. You will have the freedom to personalize the air flow intensity, angle and direction directly from the remote control and enjoy the indoor environment at the right temperature without being directly exposed to the cold draft.

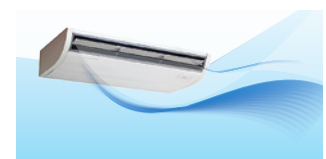

### Low consumption for low operation cost

Premium comfort doesn't mean high power consumption. By using DC motor, large air discharge surface and magic coil system, Toshiba reduces drastically the indoor unit power consumption.

### No compromise on air quality



Every indoor units are equipped with air suction filters. A symbol on the remote warns the user when filters need to be cleaned.

Example for the 4-Way Cassette size 7:



	PCB	FAN	DRAIN	TOTAL
Low fan speed	4 W	6 W	3 W	13 W
Medium fan speed	4 W	7 W	3 W	14 W
High fan speed	4 W	9 W	3 W	16 W

INDOOR UNITS, HOT WATER & FRESH AIR SOLUTIONS

		Basic specifications																	
		Class	003	005	007	009	012	015	018	024	027	030	036	048	056	072	096	112	128
Model type		Cooling/Heating capacity in kW	0.9/1.1	1.7 /1.9	2.2 /2.5	2.8 /3.2	3.6 /4	4.5 /5	5.6 /6.3	7.1 /8	8.0 /9	9.0 /10	11.2 /12.5	14.0 /16	16.0 /18	22.4/25	28.0 /31.5	33.5/20.8	40/25.2
		Cooling/Heating capacity in HP	0.3*	0.6	0.8	1	1.25	1.7	2	2.5	3	3.2	4	5	6	8	10	12	14
FOR EUROPE	Compact 4-way discharge cassette	MMU-UP***1MH-E		●	●	●	●	●	●										
	Smart 4-way discharge cassette**	MMU-UP***H-E				●	●	●	●	●	●	●	●	●	●				
	4-way discharge cassette	MMU-UP***1HP-E				●	●	●	●	●	●	●	●	●	●				
	2-way discharge cassette	MMU-UP***1WH-E			●	●	●	●	●	●	●	●	●	●	●				
	1-way discharge cassette	MMU-UP**1YP/1SH-E	●	●	●	●	●	●	●	●									
	Slim duct	MMD-UP***1SPHY-E	●	●	●	●	●	●	●	●	●								
	Concealed duct	MMD-UP***1BHPE-E		●	●	●	●	●	●	●	●	●	●	●	●				
	Concealed duct high static	MMD-UP***1HP-E							●	●	●		●	●	●	●	●	●	
	Ceiling suspended	MMC-UP***1HP-E							●	●	●	●	●	●	●				
	Floor-standing concealed	MML-UP***1BH-E			●	●	●	●	●	●	●								
	Floor-standing cabinet	MML-UP***1H-E			●	●	●	●	●	●	●								
	Bi-flow console	MML-UP***1NH-E			●	●	●	●	●	●									
	Floor standing	MMF-UP***1H-E							●	●	●	●	●	●	●				
	High wall (With & without PMV)	MMK-UP***1HP-E MMK-UP***1HPL-E	●	●	●	●	●	●	●	●	●								
	Mid temperature Hot Water module	MMW-UP**1LQ-E									●				●				
	High temperature Hot Water module	MMW-AP**1CHQ-E												●					
	EMEA AHU DX Kit (std version)	MM-DXC010 + MM-DXV***								●	●	●		●	●		●	●	
	EMEA AHU DX Kit (0/10v version)	RBC-DXC031 + MM-DXV***													●	●	●	●	
	Fresh air intake indoor unit	MMD-UP***1HFP-E												●		●	●	●	●

↑ IDU

AIR TO AIR HEAT EXCHANGER

		Basic specifications									
		Air flow in m³/h	150 m³/h	250 m³/h	350 m³/h	500 m³/h	650 m³/h	800 m³/h	1000 m³/h	1500 m³/h	2000 m³/h
Model type		Cooling/Heating capacity in kW for models with DX coil				4.1/5.5		6.5/8.6	8.2/10.9		
		Air-to-air heat exchanger	VN-M**0HE	●	●	●	●	●	●	●	●
A2A heat exchanger + DXcoil or + Dxcoil & Humidifier	MMD-VN***2HEXE MMD-VNK***2HEXE				●		●	●			

●:Heat pump  
\* Only compatible with SMMS-u  
\*\* Available mid 2021

# MMU-UP\_MH COMPACT 4-WAY CASSETTE



The Compact 4-Way Cassette is especially designed for business office applications, where a compact and efficient solution is required.

### OUTDOOR UNITS COMPATIBILITY



Side Blow & Mini SMMS-e

SMMS-u

SMMS-e

SHRM-e

### LOCAL CONTROLS



RBC-AXU31-E  
RBC-AXU31UM-E

RBC-ASCU11-E  
RBC-AMTU31-E  
RBC-AMSU51-EN/ES

CAPACITY      SOUND PRESSURE LEVEL



0.6 HP < 2 HP

29dB(A)

## Features

Model name	MMU-	UP0051MH-E	UP0071MH-E	UP0091MH-E	UP0121MH-E	UP0151MH-E	UP0181MH-E	
Capacity code	HP	0.6	0.8	1	1.3	1.7	2	
Cooling Capacity	kW	1.7	2.2	2.8	3.6	4.5	5.6	
Heating Capacity	kW	1.9	2.5	3.2	4.0	5.0	6.3	
Electrical characteristics	Power supply	1 phase 50Hz 230V(220V-240V) - Separate power supply for indoor units is required						
	Running current	A	0.16	0.23	0.24	0.25	0.28	0.46
	Power consumption (L/H)	kW	0.013/0.016	0.013/0.023	0.014/0.025	0.014/0.027	0.015/0.03	0.019/0.052
	Starting current	A	0.28	0.41	0.43	0.44	0.50	0.80
Appearance	Main unit	Zinc hot dipping steel plate (Heat-insulating material attached to only upper plate)						
	Ceiling panel	Model name	RBC-UM21PG(W)-E					
Outer dimensions		Panel color	Gran White (Mansell 5PB9/1)					
	Main unit	HxLxP	mm					
Total weight	Main unit	kg						
	Ceiling panel	kg						
Heat exchanger	Finned tube							
Soundproof/Heat-insulating material	Non-flammable insulation							
Fan unit	Fan	Turbo fan						
	Standard air flow (M+ / M / L+ / L)	m <sup>3</sup> /h	430(415/400/385/365)	552(500/462/395/378)	570(520/468/395/378)	594(550/504/420/402)	660(600/552/480/468)	840(740/642/540/522)
	Motor	W	60					
Sound pressure level High (M+ / M / L+ / L)	dB	32 (31/30/29/29)	37 (34 /33/30/29)	38 (35/33/30/29)	38 (36/34 /31/30)	40(37/35/32 /31)	47(43/39/36/34)	
Sound power level High (M+ / M / L+ / L)	dB	47 (46/45/44 /44)	52 (49/48/45/44)	53(50/48/45/44)	53 (51/49/46 /45)	55(52/50/47/46)	62 (58/54 /51/49)	
Air filter	Standard filter (Long life filter)							
Controller	Infrared or wired remote controller							
Connecting pipe	Gas side	inch	3/8"	3/8"	3/8"	3/8"	1/2"	
	Liquid side	inch	1/4"	1/4"	1/4"	1/4"	1/4"	
	Drain port (Nominal dia. mm)	VP20 (Polyvinyl chloride tube)						

## Drawings

Unit: mm

### All models

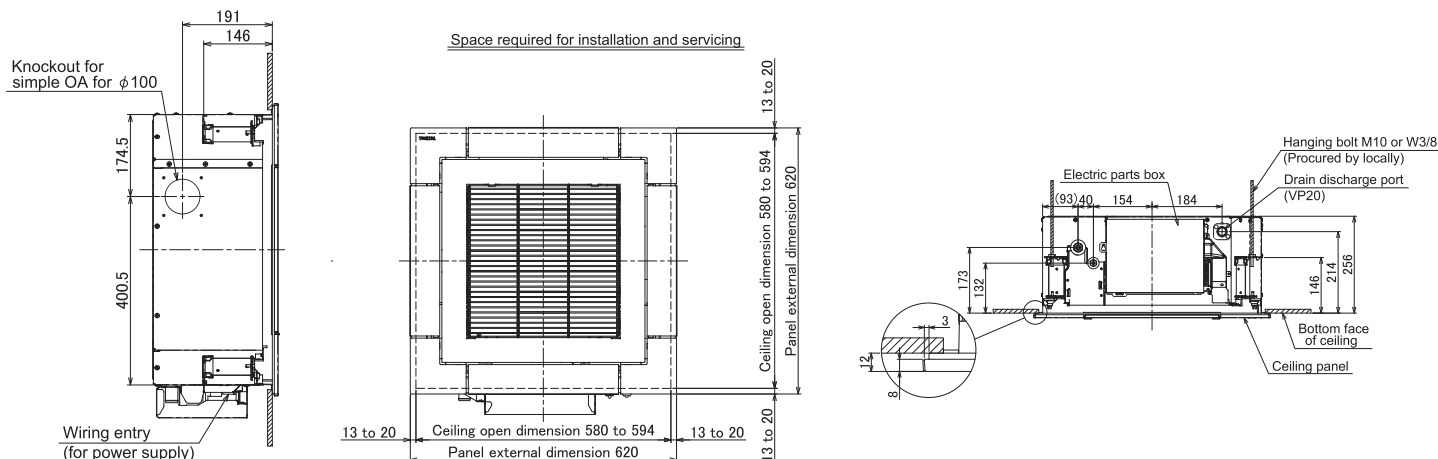



COMPACT 4-WAY CASSETTE

Sound pressure levels

Unit: dB(A)

MMU-UP0051MH-E

Fan tap	H	M	L
Sound pressure level (dB(A))	32	30	29

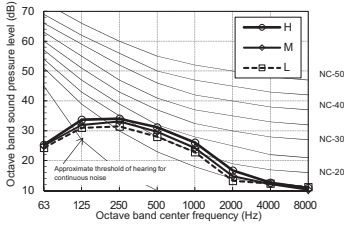

MMU-UP0071MH-E

Fan tap	H	M	L
Sound pressure level (dB(A))	37	33	29

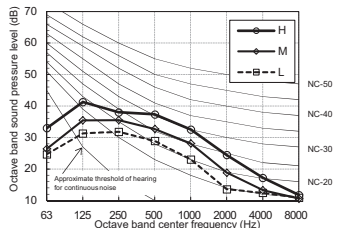

MMU-UP0091MH-E

Fan tap	H	M	L
Sound pressure level (dB(A))	38	33	29

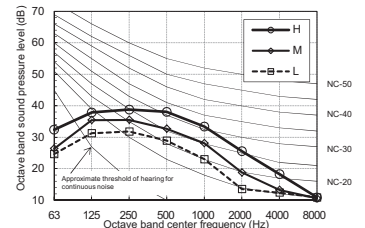

MMU-UP0121MH-E

Fan tap	H	M	L
Sound pressure level (dB(A))	38	34	30

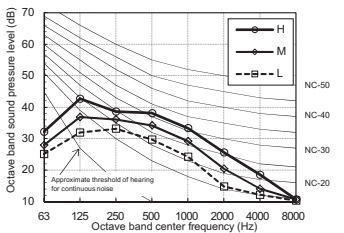

MMU-UP0151MH-E

Fan tap	H	M	L
Sound pressure level (dB(A))	40	35	31

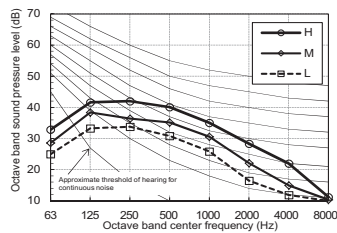

MMU-UP0181MH-E

Fan tap	H	M	L
Sound pressure level (dB(A))	47	39	34

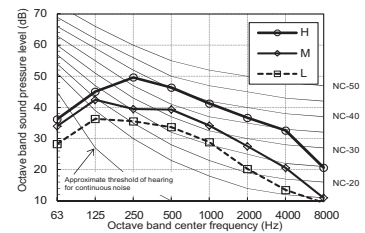

Air diffusion

Unit: m/s

MMU-UP0051MH-E

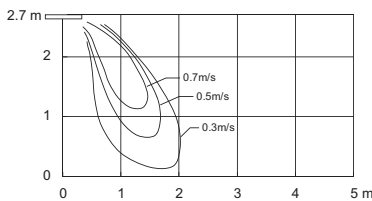

MMU-UP0071MH-E

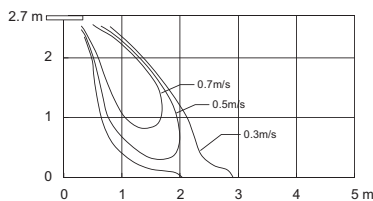

MMU-UP0091MH-E

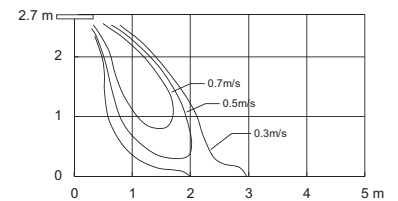

MMU-UP0121MH-E

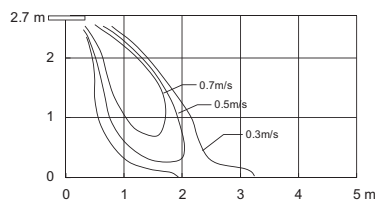

MMU-UP0151MH-E (High ceiling mode)

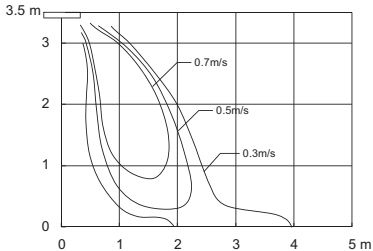

MMU-UP0181MH-E (High ceiling mode)

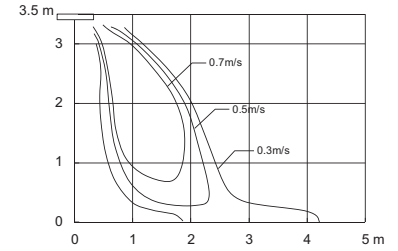

Accessories

Part name	Model name	Applied model	Notes
Ceiling panel	RBC-UM21PG(W)-E	MMU-UP___1MH-E	Required accessory
Auxiliary fresh air flange	TCB-FF101URE2		For easy fresh air intake by using the knock-out hole of indoor unit (dia=100 mm)
Wireless Remote Control kit	RBC-AXU31UM-E		*Wireless remote control kit and occupancy sensor cannot be used on the same indoor unit*
Occupancy sensor	TCB-SIR41UM-E		

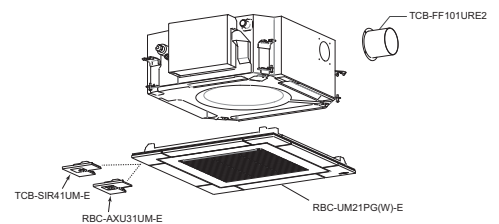

Compact 4-way cassette connectors

CN32	CN60	CN61	CN70	CN73	CN80
Additional ventilation control from remote control	Operation status signal output (Cooling, heating, fan, defrost, thermo-on)	External On/Off, operation output and alarm output	Warning symbol on remote control based on signal input. No IDU thermo off.	Forced IDU thermo-off based on signal input	Forced IDU thermo-off and IDU lock based on signal input
•	TCB-PCUC2E pcb needed	•	TCB-PCUC2E pcb needed	TCB-PCUC2E pcb needed	TCB-PCUC2E pcb needed



# MMU-UP\_HP 4-WAY CASSETTE



The 4-Way Cassette is designed to provide uniform air distribution and total user comfort making this unit the ideal solution for small commercial applications.

**CAPACITY**  
↑  
1 HP < 6 HP

**SOUND PRESSURE LEVEL**  
🔊  
27dB(A)

### OUTDOOR UNITS COMPATIBILITY



Side Blow & Mini SMMS-e    SMMS-u    SMMS-e    SHRM-e

### LOCAL CONTROLS



RBC-AXU31-E  
RBC-AXU31U-E

RBC-ASCU11-E  
RBC-AMTU31-E  
RBC-AMSU51-EN/ES

## Features

Model name	MMU-	UP0091HP-E	UP0121HP-E	UP0151HP-E	UP0181HP-E	UP0241HP-E	UP0271HP-E	UP0301HP-E	UP0361HP-E	UP0481HP-E	UP0561HP-E	
Capacity code	HP	1	1.3	1.7	2	2.5	3	3.2	4	5	6	
Cooling	kW	2.8	3.6	4.5	5.6	7.1	8.0	9.0	11.2	14.0	16.0	
Heating	kW	3.2	4.0	5.0	6.3	8.0	9.0	10.0	12.5	16.0	18.0	
Electrical characteristics	Power supply	1 phase 50Hz 230V(220V-240V) - Separate power supply for indoor units is required										
	Running current	50HZ	0.23	0.26	0.27	0.29	0.38	0.38	0.43	0.73	0.88	0.88
	Power consumption	H/M/L W	21 / 18.5 / 17.5	21 / 18.5 / 17.5	23 / 20 / 18.7	26 / 23 / 19	36 / 23 / 19	36 / 23 / 19	43 / 30 / 21	88 / 45 / 24	112 / 45 / 27	112 / 51 / 32
	Starting current	A	0.30	0.30	0.33	0.36	0.42	0.42	0.59	0.87	1.23	1.26
Appearance	Main unit	Heat-insulating material attached - Zinc hot dipping steel plate										
	Ceiling panel	Model	RBC-U32PGP-E									
		Panel color	White (Munsell: 2.5GY9.0/0.5)									
Outer dimensions	Main unit	HxLxP mm	256x840x840	256x840x840	256x840x840	256x840x840	256x840x840	256x840x840	256x840x840	319x840x840	319x840x840	319x840x840
	Ceiling panel	HxLxP mm	30x950x950	30x950x950	30x950x950	30x950x950	30x950x950	30x950x950	30x950x950	30x950x950	30x950x950	30x950x950
Total weight	Main unit	kg	18	18	20	20	20	20	25	25	25	
	Ceiling panel	kg	4	4	4	4	4	4	4	4	4	
Heat exchanger	Finned tube											
Soundproof / Heat insulating material	Non-flammable insulation											
Fan unit	Fan	Turbo fan										
	Standard air flow	H/M/L m <sup>3</sup> /h	800/730/680	800/730/680	930/830/790	1050/920/800	1290/920/800	1290/920/800	1320/1100/850	1970/1430/1070	2130/1430/1130	2130/1520/1230
	Motor output	W	14		20		68		72			
Sound pressure level	H/M/L dB(A)	30/29/27	30/29/27	31/29/27	32/29/27	35/31/28	35/31/28	38/33/30	43/38/32	46/38/33	46/40/33	
Sound power level	H dB(A)	45	45	46	47	50	50	53	58	61	61	
Air filter	Long life filter											
Controller	Wired or infrared remote controller											
Connecting pipe	Gas pipe	inch	3/8"	3/8"	1/2"	1/2"	5/8"	5/8"	5/8"	5/8"	5/8"	
	Liquid pipe	inch	1/4"	1/4"	1/4"	1/4"	3/8"	3/8"	3/8"	3/8"	3/8"	
	Drain port (Outside dia.)	mm	25 (Polyvinyl chloride tube)									

## Drawings

Unit: mm

MMU-UP0091HP-E to MMU-UP0301HP-E

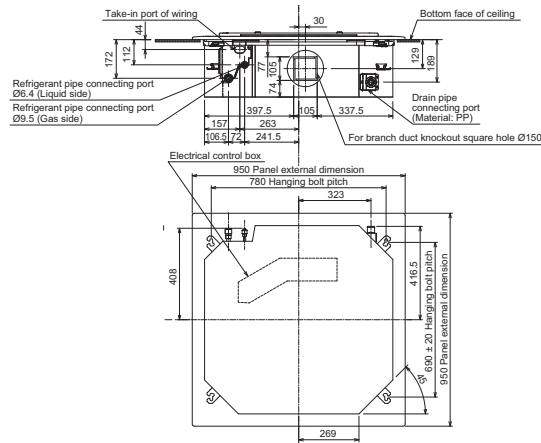

MMU-UP0361HP-E to MMU-UP0561HP-E

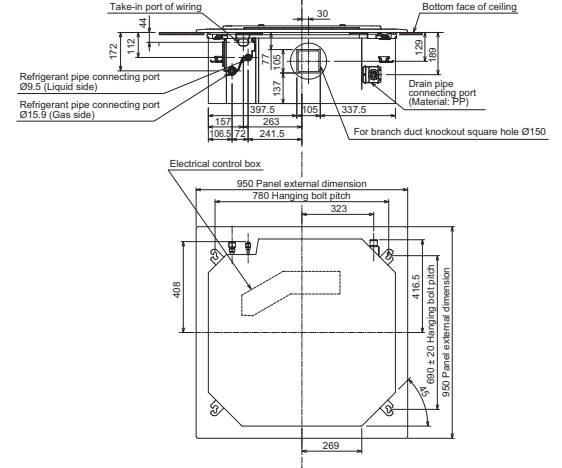

## 4-WAY CASSETTE

### Sound pressure levels

Unit: dB(A)

**MMU-UP0091HP-E, UP0121HP-E**

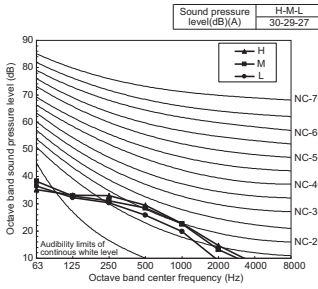

**MMU-UP0151HP-E**

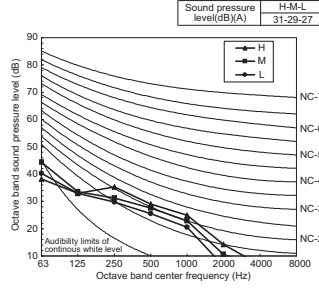

**MMU-UP0181HP-E**

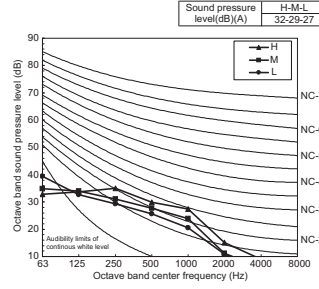

**MMU-UP0241HP-E, UP0271HP-E**

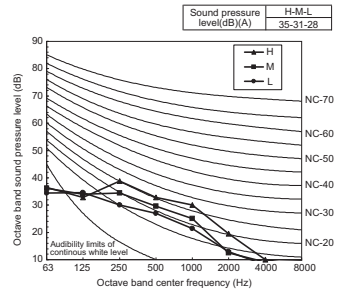

**MMU-UP0301HP-E**

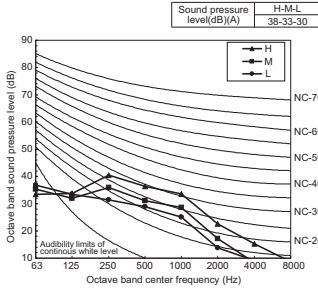

**MMU-UP0361HP-E**

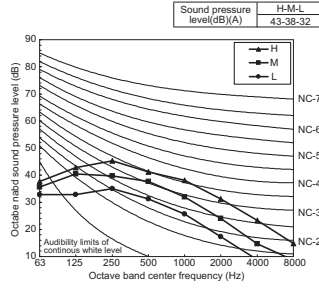

**MMU-UP0481HP-E Sound**

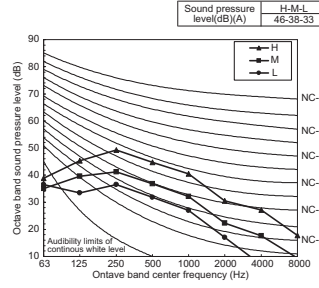

**MMU-UP0561HP-E Sound**

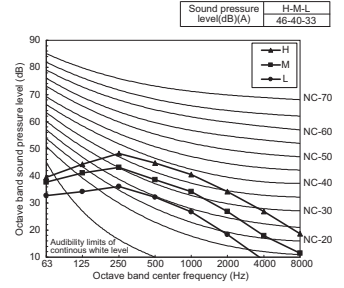

### Air diffusion

Unit: m/s

**MMU-UP0091HP-E, UP0121HP-E**

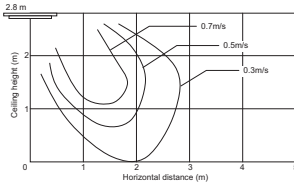

**MMU-UP0151HP-E, UP0181HP-E**

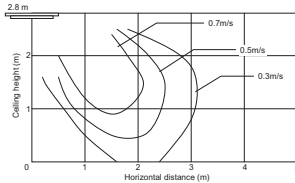

**MMU-UP0241HP-E, UP0271HP-E, UP0301HP-E**

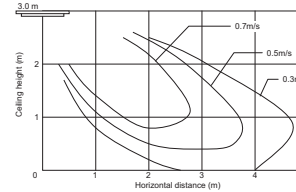

**MMU-UP0361HP-E**

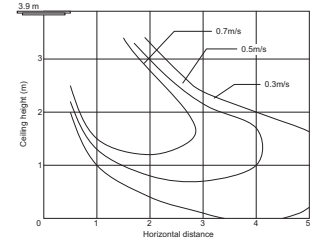

**MMU-UP0481HP-E, UP0561HP-E**

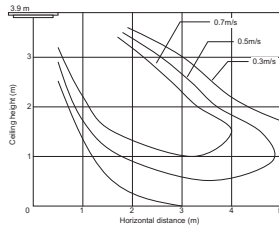

**MMU-UP0361HP-E, UP0481HP-E, UP0561HP-E (High ceiling 3)**

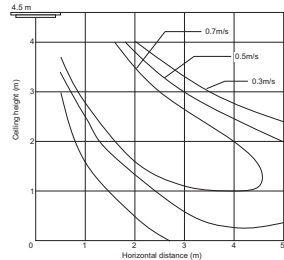

### Accessories

No	Type	Model name	Qty/unit	Note
1	Ceiling Panel (Wide-flow louver)	RBC-U32PGP-E	1	White (Munsell: 2.5GY9.0/0.5)
2	Spacer for height adjustment	TCB-SP1602UE	1	50 mm
3	Fresh air chamber	TCB-GFC1602UE	1	Use with TCB-GB1602U
4	Fresh air intake box	TCB-GB1602UE	1	Connection=Dia.100 mm fresh air intake ratio: Up to 20%
5	Air discharge direction kit	TCB-BC1602UE	1	6-direction patterns
6	Auxiliary fresh air flange	TCB-FF101URE2	1	Connection=Dia.100 mm fresh air intake ratio: Up to 5%

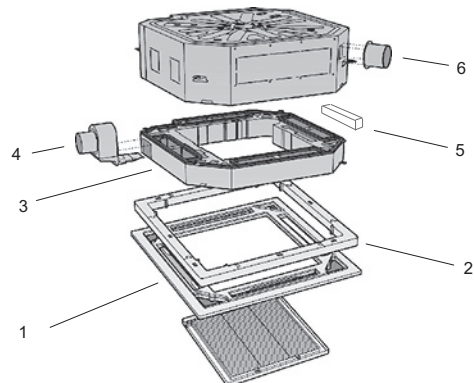

### 4-way cassette connectors

CN32	CN60	CN61	CN70	CN73	CN80
Additional ventilation control from remote control	Operation status signal output (cooling, heating, fan, defrost, thermo-on)	External On/Off, operation output and alarm output	Warning symbol on remote control based on signal input. No IDU thermo off.	Forced IDU thermo-off based on signal input	Forced IDU thermo-off and IDU lock based on signal input
•	•	•	•	•	•

# MMU-UP\_WH 2-WAY CASSETTE



Slim, compact and lightweight, the 2-Way Cassette has been designed to fit easily and discreetly into any room interior.

**CAPACITY**  
↑  
**0.8HP < 6HP**

**SOUND PRESSURE LEVEL**  
  
**30dB(A)**

### OUTDOOR UNITS COMPATIBILITY

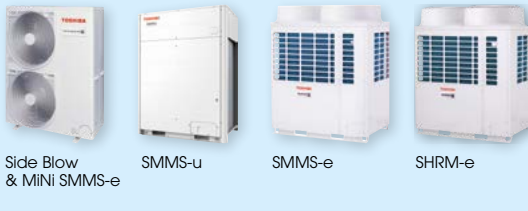

### LOCAL CONTROLS



### Features

Model name	MMU-UP0071WH-E	UP0091WH-E	UP0121WH-E	UP0151WH-E	UP0181WH-E	UP0241WH-E	UP0271WH-E	UP0301WH-E	UP0361WH-E	UP0481WH-E	UP0561WH-E			
Capacity code	HP	0.8	1	1.3	1.7	2	2.5	3	3.2	4	5	6		
Cooling capacity	kW	2.2	2.8	3.6	4.5	5.6	7.1	8.0	9.0	11.2	14.0	16.0		
Heating capacity	kW	2.5	3.2	4.0	5.0	6.3	8.0	9.0	10.0	12.5	16.0	18.0		
Electrical characteristics	Power supply	1 phase 50Hz 220-240V / 1 phase 60Hz 220V (Separate power supply for indoor units is required.)												
	Running current	50 Hz	A	0.23	0.23	0.23	0.24	0.32	0.39	0.39	0.46	0.48	0.57	0.75
	Power consumption H/L	kW	0.029 / 0.026	0.029 / 0.026	0.029 / 0.026	0.03 / 0.026	0.044 / 0.037	0.054 / 0.045	0.054 / 0.045	0.064 / 0.062	0.073 / 0.60	0.088 / 0.07	0.117 / 0.089	
Appearance	Starting current	A	0.35	0.35	0.35	0.36	0.48	0.59	0.69	0.72	0.86	1.13		
	Main unit	Heat-insulating material attached Zinc hot dipping steel plate												
Outer dimensions	Ceiling panel	Model	RBC-UW283PG(W)-E				RBC-UW803PG(W)-E				RBC-UW1403PG(W)-E			
		Panel colour	Moon white_(Munsell 2.5GY9.0/0.5)											
Total weight	Main unit	HxLxP	295x815x570				345x1180x570				345x1600x570			
	Ceiling panel	HxLxP	20x1050x680				20x1415x680				20x1835x680			
Heat exchanger	Main unit	kg	19	19	19	19	26	26	26	36	36	36		
	Ceiling panel	kg	10	10	10	10	10	14	14	14	14	14		
Soundproof / Heat-insulating material	Finned tube													
Fan unit	Fan	Non-flammable insulation												
	Standard air flow (High/Mid/Low)	m³/h	Turbo fan				Centrifugal fan							
	Motor output	W	558 / 498 / 450				600/534/ 450 900/750/ 618				1050 / 840 / 738 1250/900/ 780 1740/1434/ 1182 1800/1482/ 1230 2040/1578/ 1320			
Sound pressure level (High/Mid/Low)	dB(A)	34 / 32 / 30				35 / 33 / 30				38 / 35 / 33 40/37/34 42/39/36 43/40/37 46/42/39				
Sound power level (High)	dB(A)	49				50				53 55 57 58 61				
Air filter	Standard filter (Long life filter)													
Controller	Infrared or wired remote controller													
Connecting pipe	Gas pipe	inch	3/8"	3/8"	3/8"	1/2"	1/2"	5/8"	5/8"	5/8"	5/8"	5/8"		
	Liquid pipe	inch	1/4"	1/4"	1/4"	1/4"	1/4"	3/8"	3/8"	3/8"	3/8"	3/8"		
	Drain port (Nominal dia.)	mm	25 (Polyvinyl chloride tube)											

### Drawings

Unit: mm

MMU-UP0071WH-E to MMU-UP0151WH-E

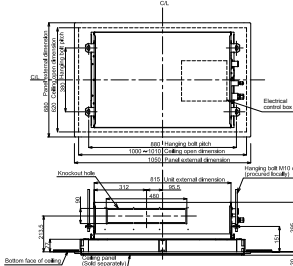

MMU-UP0181WH-E to MMU-UP0301WH-E

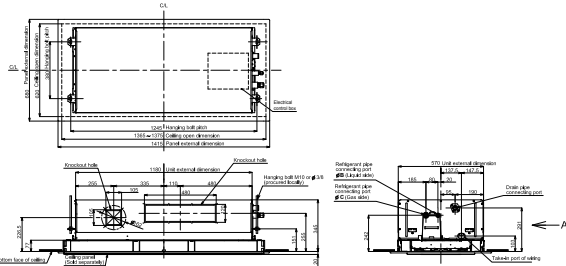

MMU-UP0361WH-E to MMU-UP0561WH-E

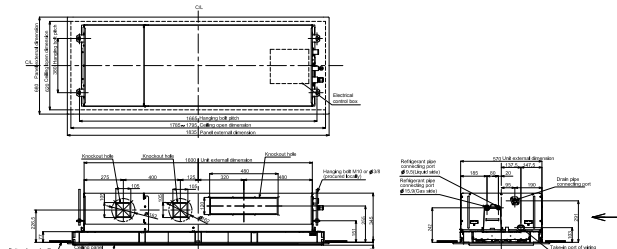

Sound pressure levels

Unit: dB(A)

MMU-UP0071WH-E, UP0091WH-E, UP0121WH-E

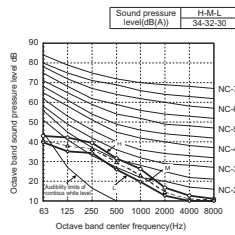

MMU-UP0151WH-E

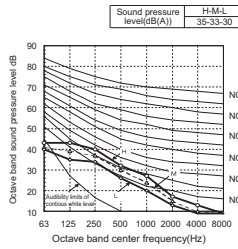

MMU-UP0181WH-E

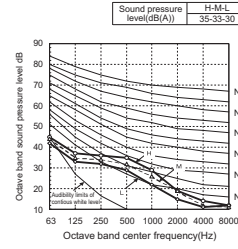

MMU-UP0241WH-E, UP0271WH-E

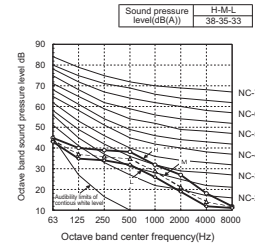

MMU-UP0301WH-E

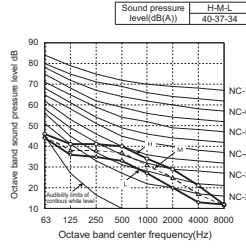

MMU-UP0361WH-E

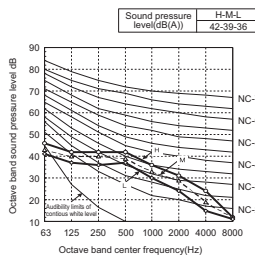

MMU-UP0481WH-E

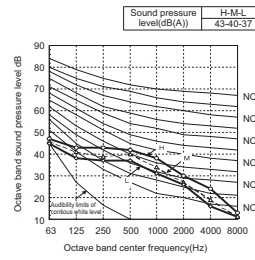

MMU-UP0561WH-E

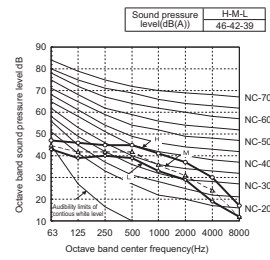

Air diffusion

Unit: m/s

MMU-UP0071WH-E/UP0091WH-E, UP0121WH-E, UP0151WH-E

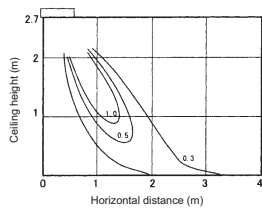

MMU-UP0181WH-E

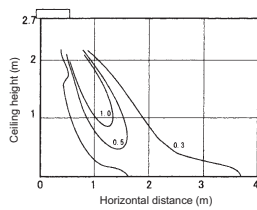

MMU-UP0241WH-E, UP0271WH-E

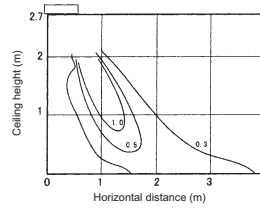

MMU-UP0301WH-E

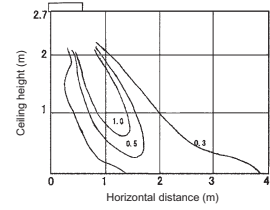

MMU-UP0361WH-E, UP0481WH-E

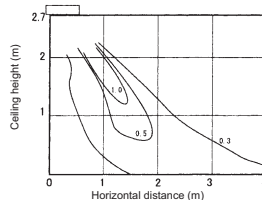

MMU-UP0561WH-E

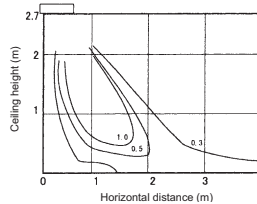

Accessories

No	Part name	Model name	Applied model	Notes	Remarks
1	Ceiling panel	RBC-UW283PG(W)-E	MMU-UP0071 to 0151WH	Required accessory	
		RBC-UW803PG(W)-E	MMU-UP0181 to 0301WH		
		RBC-UW1403PG(W)-E	MMU-UP0361 to 0561WH		
2	Super long life filter	TBC-LF283UW-E	MMU-UP0071 to 0151WH	Dust collecting effect: 50% (Weight method)	Use with TBC-FC283UW-E
		TBC-LF803UW-E	MMU-UP0181 to 0301WH		Use with TBC-FC803UW-E
		TBC-LF1403UW-E	MMU-UP0361 to 0561WH		Use with TBC-FC1403UW-E
3	Filter chamber	TBC-FC283UW-E	MMU-UP0071 to 0151WH	For super long life filter	
		TBC-FC803UW-E	MMU-UP0181 to 0301WH		
		TBC-FC1403UW-E	MMU-UP0361 to 0561WH		
4	Auxiliary fresh air flange	TBC-FF151US-E	MMU-UP0071 to 0561WH	For fresh air intake by using the knockout hole of indoor unit.	

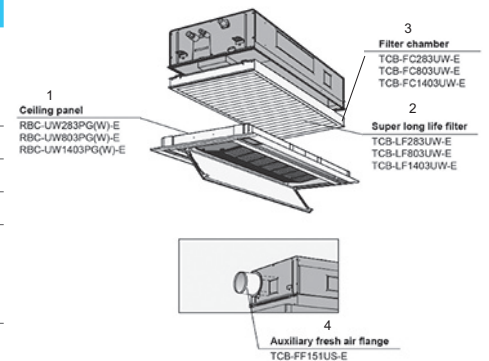

2-way cassette connectors

CN32	CN60	CN61	CN70	CN73	CN80
Additional ventilation control from remote control	Operation status signal output (cooling, heating, fan, defrost, thermo-on)	External On/Off, operation output and alarm output	Warning symbol on remote control based on signal input. No IDU thermo off.	Forced IDU thermo-off based on signal input	Forced IDU thermo-off and IDU lock based on signal input
•	•	•	•	•	•



MMU-UP\_YHP/SH  
1-WAY CASSETTE

**> NEW**



Toshiba's innovative slim-line 1-Way Cassette is simple to install and suitable for small areas, such as hotels, offices and reception rooms.

OUTDOOR UNITS COMPATIBILITY



Side Blow & Mini SMMS-e

SMMS-u

SMMS-e

SHRM-e

LOCAL CONTROLS

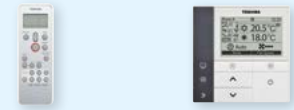

RBC-AXU31C-E  
RBC-AX33UYP-E  
(YHP only)

RBC-ASCU11-E  
RBC-AMTU31-E  
RBC-AMSU51-EN/ES

CAPACITY **0.3 HP < 2.5 HP**

SOUND PRESSURE LEVEL **25dB(A)**

Features

PRELIMINARY DATA

Model name	MMU-	UP0031YHP-E	UP0051YHP-E	UP0071YHP-E	UP0091YHP-E	UP0121YHP-E	UP0151SH-E	UP0181SH-E	UP0241SH-E		
Capacity code	HP	0,3	0,6	0,8	1	1,3	1,7	2	2,5		
Cooling capacity	kW	0,9	1,7	2,2	2,8	3,6	4,5	5,6	7,1		
Heating capacity	kW	1,3	1,9	2,5	3,2	4	5	6,3	8		
Electrical characteristics	Power supply	1 phase 50Hz 220-240V / 1 phase 60Hz 220V (Separate power supply for indoor units is required.)					1 phase 50Hz 220-240V / 1 phase 60Hz 220V (Separate power supply for indoor units is required.)				
	Running current	50 Hz	0,15	0,15	0,18	0,19	0,20	0,34	0,37	0,62	
		60 Hz	N/A	N/A	N/A	N/A	N/A	0,35	0,39	0,62	
	Power consumption (50/60Hz)	kW	0,015	0,015	0,017	0,018	0,018	0,042 / 0,041	0,046 / 0,045	0,075 / 0,073	
	Starting current (50/60Hz)	A	N/A	N/A	N/A	N/A	0,51 / 0,53	0,54 / 0,54	0,80 / 0,80		
Appearance	Main unit	Heat-insulating material attached Zinc hot dipping steel plate									
Ceiling panel	Model	RBC-UY32P-E						RBC-US21PGE			
Panel colour		Moon white (Munsell 2.5GY9.0/0.5)									
Outer dimension	Main unit	HxLxP	150x990x450					200x1000x710			
	Ceiling panel	HxLxP	30x1220x530					20x1230x800			
Total weight	Main unit	kg	14					21			
	Ceiling panel	kg	4					5,5			
Heat exchanger		Finned tube									
Sound proof / Heat-insulating material		Non-flammable insulation					Polyethylene foam + Expanded polyethylene				
Fan unit	Fan		Centrifugal fan					Centrifugal fan			
	Standard air flow (High/Mid./Low)	m³/h	480/370/270	480/370/270	500/390/270	520/410/290	540/420/290	750 / 690 / 630	780 / 720 / 660	1140 / 960 / 810	
	Motor output	W	30								
Sound pressure level (High/Mid/Low)	dB(A)	37/33/25	37/33/25	38/34/25	39/35/26	40/36/26	37 / 35 / 32	38 / 36 / 34	45 / 41 / 37		
Sound power level (High)	dB(A)	N/A	N/A	N/A	N/A	N/A	52	53	60		
Air filter		Standard filter (Long life filter) / Air purifier available as option						Standard filter (Long life filter)			
Controller		Remote controller									
Connecting pipe	Gas pipe	inch	3/8"	3/8"	3/8"	3/8"	3/8"	1/2"	1/2"	5/8"	
	Liquid pipe	inch	1/4"	1/4"	1/4"	1/4"	1/4"	1/4"	1/4"	3/8"	
	Drain port (Nominal dia.)	mm	25 (Polyvinyl chloride tube)								

Drawings

Unit: mm

MMU-UP0031YHP-E to MMU-UP0121YHP-E

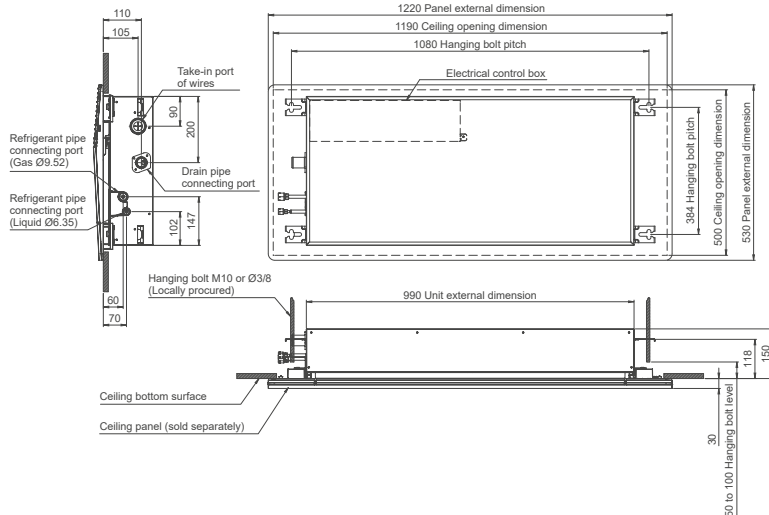

MMU-UP0151SH-E to MMU-UP0241SH-E

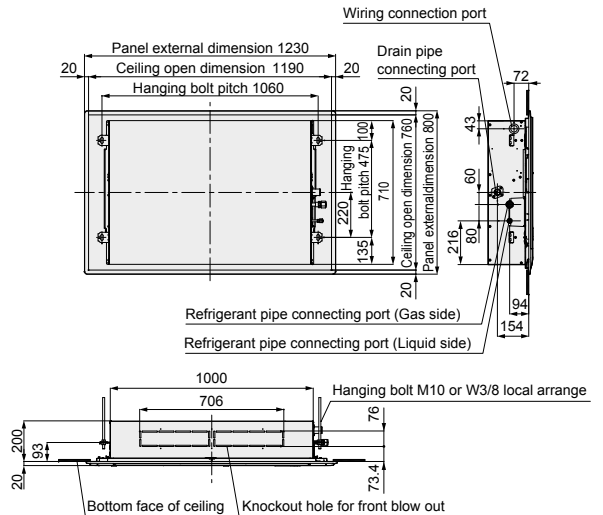

## 1-WAY CASSETTE

### Sound pressure levels

Unit: dB(A)

#### MMU-UP0031YHP-E to MMU-UP0121YHP-E

GRAPH IN PROGRESS

#### MMU-UP0151SH-E

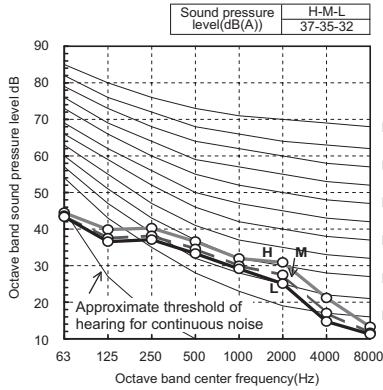

#### MMU-UP0181SH-E

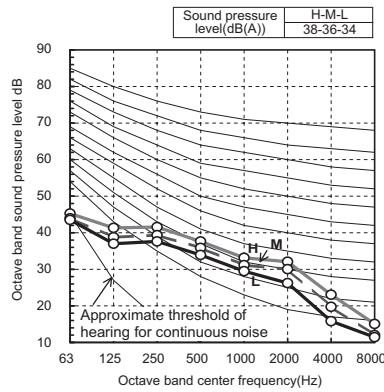

#### MMU-UP0241SH-E

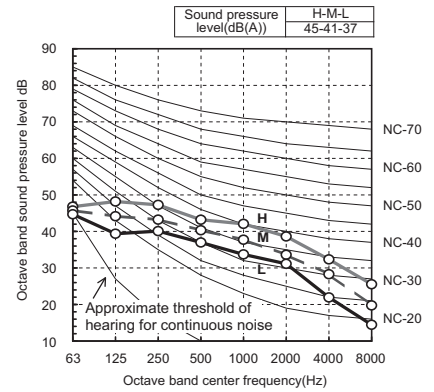

### Air diffusion

Unit: m/s

#### MMU-UP0031YHP-E to MMU-UP0121YHP-E

GRAPH IN PROGRESS

#### MMU-UP0151SH-E, UP0181SH-E

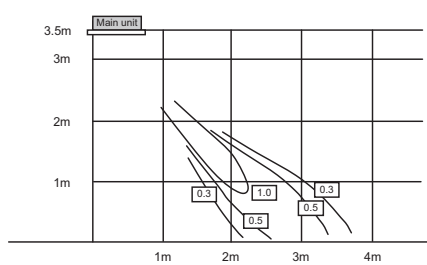

#### MMU-UP0241SH-E

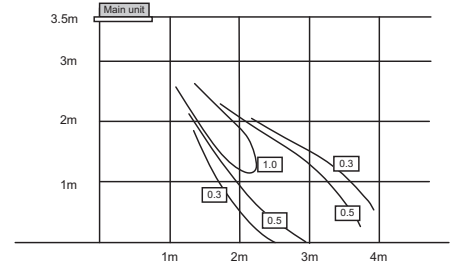

### Accessories

No	Part name	Model name	Applied model	Note	Remarks
1	Panel	RBC-UY32P-E	MMU-UP_1YHP-E	1-Way cassette panel without receiver	Required accessory
		RBC-US21PGE			Required accessory
2	Front air discharge unit	TCB-BUS21HWE	MMU-UP_1SH-E		
3	Auxiliary fresh air flange	TCB-FF101URE2		For easy fresh air intake by using the knockout hole of indoor unit. (dia.=100 mm)	
-	Air purifier kit	TCB-EAPC1UYHP-E	MMU-UP-1YHP-E	Set of Plasma Air Purifier, Dust sensor, Air quality indicator and Wireless receiver	
-	Occupancy sensor	TCB-SIR41UYHP-E	MMU-UP-1YHP-E	Occupancy sensor	Cannot match with Wireless receiver Kit
-	Wireless receiver kit	RBC-AX33UYHP-E	MMU-UP-1YHP-E	Wireless RC kit	Cannot match with Occupancy sensor

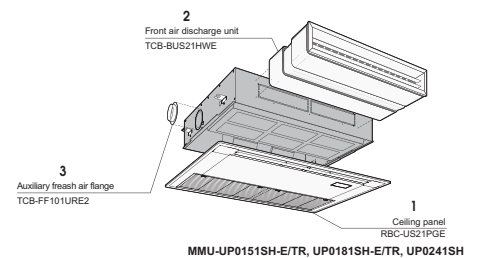

### 1-way cassette connectors

	CN32	CN60	CN61	CN70	CN73	CN80
Additional ventilation control from remote control		Operation status signal output (cooling, heating, fan, defrost, thermo-on)	External On/Off, operation output and alarm output	Warning symbol on remote control based on signal input. No IDU thermo off	Forced IDU thermo-off based on signal input	Forced IDU thermo-off and IDU lock based on signal input
YHP	•	TCB-PCUC2E pcb needed	•	TCB-PCUC2E pcb needed	TCB-PCUC2E pcb needed	TCB-PCUC2E pcb needed
SHP	•	•	•	•	•	•

# MMD-UP\_BHP STANDARD DUCT

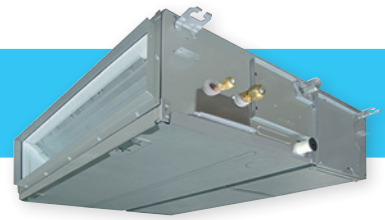

Whatever the shape of the room, this flexible model ensures a uniform temperature and air distribution for optimal end user comfort.

### OUTDOOR UNITS COMPATIBILITY

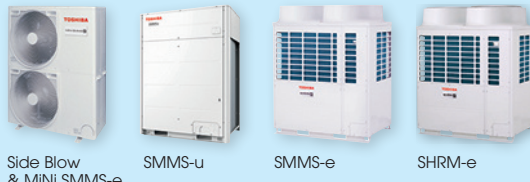

Side Blow & Mini SMMS-e    SMMS-u    SMMS-e    SHRM-e

### LOCAL CONTROLS



RBC-AXU31-E    RBC-ASCU11-E  
RBC-AMTU31-E    RBC-AMSU51-EN/ES

**CAPACITY**  
↑  
**0.6HP < 6HP**

**SOUND PRESSURE LEVEL**  
  
**23dB(A)**

## Features

Model name	MMD-UP0051BHP-E	UP0071BHP-E	UP0091BHP-E	UP0121BHP-E	UP0151BHP-E	UP0181BHP-E	UP0241BHP-E	UP0271BHP-E	UP0301BHP-E	UP0361BHP-E	UP0481BHP-E	UP0561BHP-E		
Capacity code	HP	0.6	0.8	1	1.3	1.7	2	2.5	3	3.2	4	5	6	
Cooling capacity	kW	1,7	2,2	2,8	3,6	4,5	5,6	7,1	8,0	9,0	11,2	14,0	16,0	
Heating capacity	kW	1,9	2,5	3,2	4,0	5,0	6,3	8,0	9,0	10,0	12,5	16,0	18,0	
Electrical characteristics	Power supply	1 phase 50 Hz 220-240 V / 1 phase 60 Hz 220 V (Separate power supply for indoor units is required.)												
	Running current 50 Hz	A	0,35	0,35	0,38	0,38	0,70	0,70	0,80	0,80	0,95	1,29	1,70	1,70
	Power consumption	kW	0,055	0,055	0,060	0,060	0,110	0,110	0,135	0,135	0,160	0,220	0,290	0,290
	Starting current	A	0,75	0,75	0,64	0,64	1,24	1,24	1,58	1,58	1,78	2,19	2,66	2,66
Appearance		Zinc hot dipping steel plate												
Dimensions	HxLxP	mm	275x700x750						275x1000x750			275x1400x750		
Total weight	kg		23						30			40		
Heat exchanger		Finned tube												
Soundproof / Heat-insulating material		Polyethylene foam												
Fan unit	Fan	Centrifugal fan												
	Standard air flow (High / Mid. / Low)	m <sup>3</sup> /h	540/450/360	540/450/360	570/480/390	570/480/390	920/660/540	920/660/540	1320/1090/870	1320/1090/870	1450/1200/960	1920/1620/1380	2350/1920/1500	2350/1920/1500
	Motor output	W	150						250					
	External static pressure (factory default)	Pa	30						40			50		
	External static pressure	Pa	30 - 40 - 50 - 65 - 80 - 100 - 120 - 150											
Sound pressure level (High / Mid. / Low)	dB(A)	29/26/23	29/26/23	30/26/23	30/26/23	33/29/25	33/29/25	33/30/27	33/30/27	36/31/27	36/34/31	40/36/33	40/36/33	
Sound power level	dB(A)	51	51	52	52	55	55	58	58	58	63	63	63	
Air filter		Standard filter (Long life filter)												
Controller		Remote controller												
Connecting pipe	Gas side	inch	3/8"	3/8"	3/8"	3/8"	1/2"	1/2"	5/8"	5/8"	5/8"	5/8"	5/8"	
	Liquid side	inch	1/4"	1/4"	1/4"	1/4"	1/4"	1/4"	3/8"	3/8"	3/8"	3/8"	3/8"	
	Drain port (Nominal dia.)	mm	25 (Polyvinyl chloride tube)											

## Drawings

Unit: mm

MMD-UP0051BHP-E to MMD-UP0181BHP-E

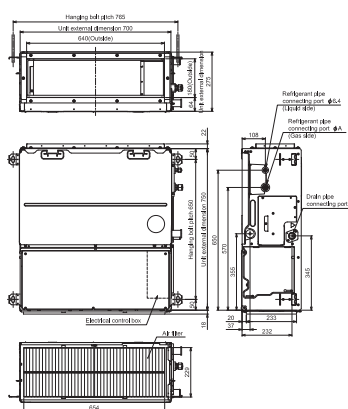

MMD-UP0241BHP-E to MMD-UP0301BHP-E

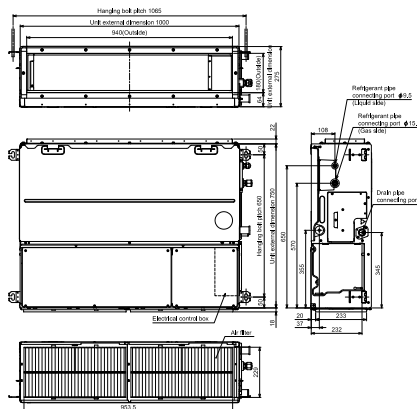

MMD-UP0361BHP-E to MMD-UP0561BHP-E

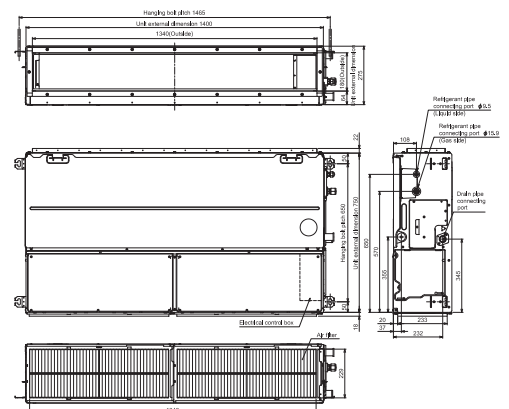



Unit: dB(A)

Sound pressure levels

MMD-UP0051BHP-E, MMD-UP0071BHP-E

External static pressure 80 Pa

FAN tap	H	M	L
Sound pressure level (dB(A))	33	30	27

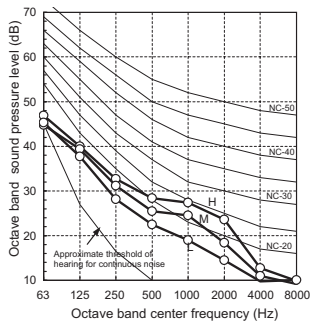

MMD-UP0091BHP-E, MMD-UP0121BHP-E

External static pressure 80 Pa

FAN tap	H	M	L
Sound pressure level (dB(A))	34	30	28

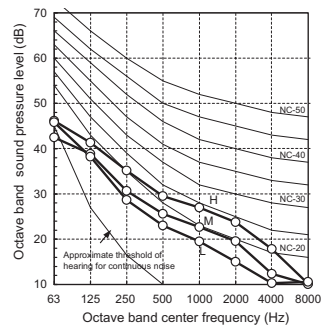

MMD-UP0151BHP-E, MMD-UP0181BHP-E

External static pressure 80 Pa

FAN tap	H	M	L
Sound pressure level (dB(A))	37	33	31

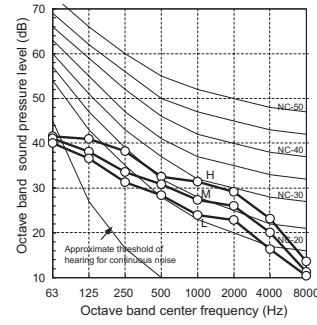

MMD-UP0241BHP-E, MMD-UP0271BHP-E

External static pressure 80 Pa

FAN tap	H	M	L
Sound pressure level (dB(A))	42	38	33

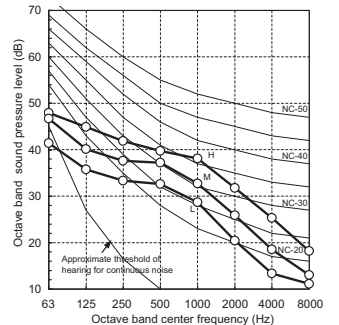

MMD-UP0301BHP-E

External static pressure 80 Pa

FAN tap	H	M	L
Sound pressure level (dB(A))	42	39	33

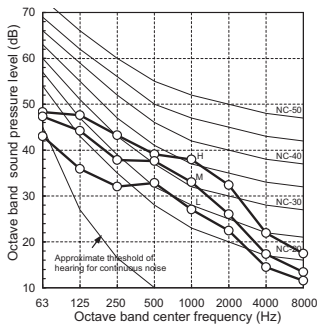

MMD-UP0361BHP-E

External static pressure 80 Pa

FAN tap	H	M	L
Sound pressure level (dB(A))	41	39	35

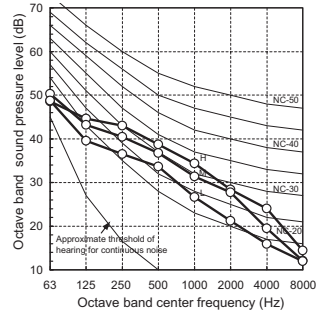

MMD-UP0481BHP-E, MMD-UP0561BHP-E

External static pressure 80 Pa

FAN tap	H	M	L
Sound pressure level (dB(A))	41	40	36

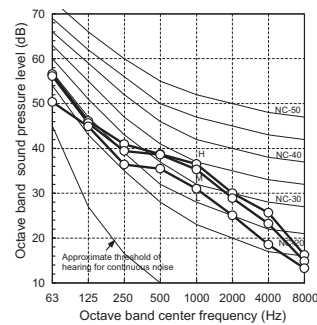

Accessories

Type	Model name	Applied model	Appearance	Remarks
Spigot shaped flange	TCB-SF56C6BE	MMD-UP0071/0091/0121/0151/0181BHP-E		263x694x175mm / Spigot diameter 200mm
	TCB-SF80C6BE	MMD-UP0241/0271/0301BHP-E		263x994x175mm / Spigot diameter 200mm
	TCB-SF160C6BE	MMD-UP0361/0481/0561BHP-E		263x1394x175mm / Spigot diameter 200mm

Standard duct connectors

CN32	CN60	CN61	CN70	CN73	CN80
Additional ventilation control from remote control	Operation status signal output (cooling, heating, fan, defrost, thermo-on)	External On/Off, operation output and alarm output	Warning symbol on remote control based on signal input. No IDU thermo off.	Forced IDU thermo-off based on signal input	Forced IDU thermo-off and IDU lock based on signal input
.	.	.	.	.	.

Installation flexibility

Changing from back air intake to under air intake

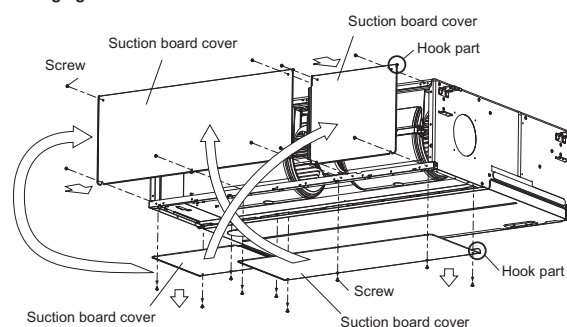



Whether installed in a ceiling void or in a false ceiling, Toshiba Slim Duct offers the ultimate technology, with exceptional energy savings, high performance and easy installation.

OUTDOOR UNITS COMPATIBILITY



LOCAL CONTROLS



CAPACITY **↑**  
0.3 HP < 3 HP

SOUND PRESSURE LEVEL **↓**  
25dB(A)

Features

PRELIMINARY DATA

Model name	MMD-	UP0031SPHY-E	UP0051SPHY-E	UP0071SPHY-E	UP0091SPHY-E	UP0121SPHY-E	UP0151SPHY-E	UP0181SPHY-E	UP0241SPHY-E	UP0271SPHY-E	
Capacity code	HP	0,3	0,6	0,8	1	1,3	1,5	2	2,5	3	
Cooling capacity	kW	0,9	1,7	2,2	2,8	3,6	4,5	5,6	7,1	8	
Heating capacity (1)	kW	1	1,9	2,5	3,2	4	5	6,3	8	9	
Electrical characteristics	Power supply	1 phase 50 Hz 220-240 V / 1 phase 60 Hz 208-230V									
	Running current 50Hz / 60Hz	A	0.34 / 0.36	0.36 / 0.37	0.40 / 0.42	0.42 / 0.44	0.44 / 0.46	0.47 / 0.49	0.53 / 0.56	0.69 / 0.73	0.74 / 0.78
	Power consumption	kW	0,018	0,02	0,026	0,029	0,031	0,035	0,044	0,067	0,072
	Starting current 50Hz / 60Hz	A	0.60 / 0.63	0.62 / 0.65	0.69 / 0.73	0.73 / 0.77	0.77 / 0.81	0.82 / 0.86	0.92 / 0.97	1.21 / 1.27	1.30 / 1.36
Appearance		Zinc hot dipping steel plate									
Outer dimension HxLxP	mm	210x700x450			210x900x450			210x1110x450			
Total weight	kg	15			18			21			
Heat exchanger		Finned tube									
Soundproof / Heat-insulating material		Polyethylene foam + Polyurethane foam									
Fan unit	Fan	Centrifugal fan (sirocco fan)									
	Standard air flow (H/M+/M/L+/L)	m³/h	410/390/370/360/350	450/430/410/390/380	540/500/460/430/400	570/530/500/450/420	600/550/520/470/440	690/660/640/590/550	780/760/730/690/650	1080/1010/950/900/860	1140/1060/980/940/910
	Motor output	W	50						94		
External static pressure	Pa	10 (factory setting) -20-30-40-50									
Sound pressure level (H/M+/M/L+/L)	Under air intake	dB(A)	37/36/35/34/32	39/38/37/35/34	41/40/39/38/35	42/41/40/38/36	44/42/40/39/37	42/40/39/38/37	44/43/42/41/39	47/46/44/43/41	48/47/45/44/43
	Back air intake	dB(A)	29/28/27/26/25	30/29/28/27/26	31/30/29/28/26	32/31/29/28/26	33/32/30/29/27	33/31/30/29/28	34/33/32/31/29	36/35/33/32/30	37/36/34/33/32
Sound power level (H/M+/M/L+/L)	dB(A)	46/45/44/43/42	49/47/46/45/44	52/51/49/47/45	54/52/50/48/46	54/51/50/48/46	52/51/50/49/46	56/55/54/52/51	60/58/56/55/53	61/59/58/56/55	
Air filter		Standard filter supplied (Long life filter)									
Controller		Remote controller									
Connecting pipe	Gas pipe	inch	3/8"	3/8"	3/8"	3/8"	3/8"	1/2"	1/2"	5/8"	5/8"
	Liquid pipe	inch	1/4"	1/4"	1/4"	1/4"	1/4"	1/4"	1/4"	3/8"	3/8"
	Drain pipe (Outside dia.)	mm	25 (Polyvinyl chloride tube : External dia.32 Internal dia.25)								

Drawings

Unit: mm

MMD-UP0031SPHY-E to MMD-UP0271SPHY-E

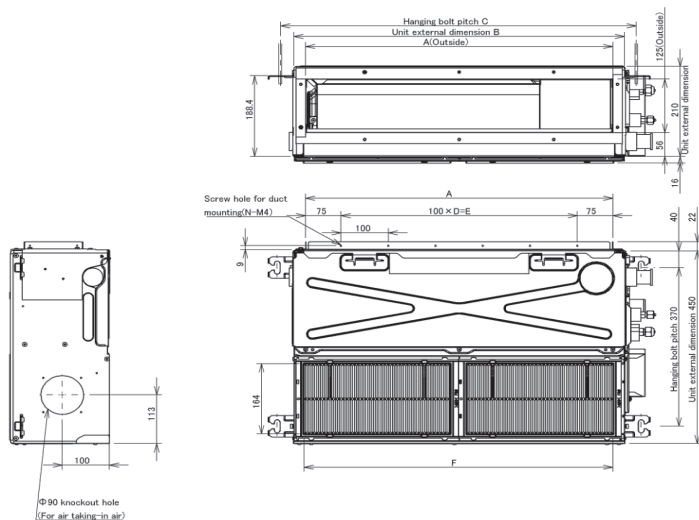

MMD-UP***1SPHY-E	003~012	015~018	024~027
A	650	850	1050
B	700	900	1100
C	770	970	1170
D	5	7	9
E	500	700	900
F	655	855	1055
G	6.4		
H	9.5	12.7	15.9

Unit: dB(A)

Sound pressure levels

MMD-UP0031SPHY-E

Sound Pressure Level (dBA)	H	M+	M	L+	L
	29	28	27	26	25

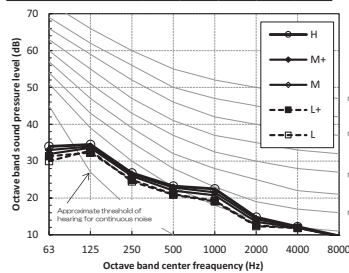

UP0051SPHY-E

Sound Pressure Level (dBA)	H	M+	M	L+	L
	30	29	28	27	26

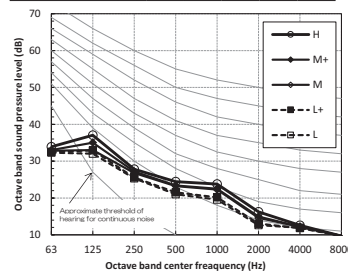

UP0071SPHY-E

Sound Pressure Level (dBA)	H	M+	M	L+	L
	31	30	29	28	26

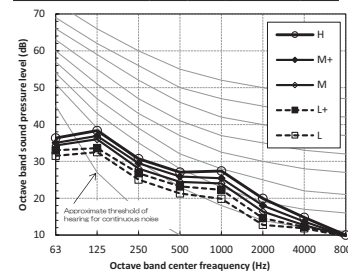

UP0091SPHY-E

Sound Pressure Level (dBA)	H	M+	M	L+	L
	32	31	29	28	26

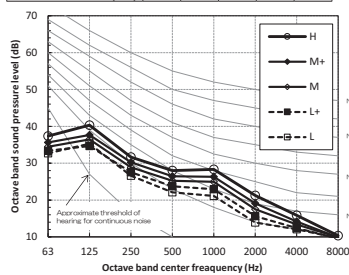

UP0121SPHY-E

Sound Pressure Level (dBA)	H	M+	M	L+	L
	33	32	30	29	27

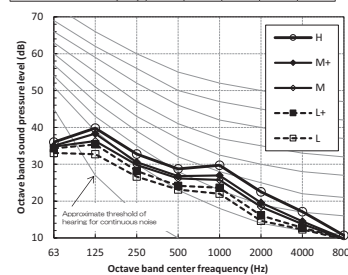

UP0151SPHY-E

Sound Pressure Level (dBA)	H	M+	M	L+	L
	33	31	30	29	28

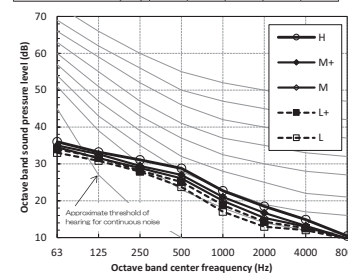

UP0181SPHY-E

Sound Pressure Level (dBA)	H	M+	M	L+	L
	34	33	32	31	29

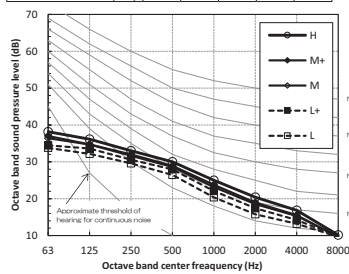

UP0241SPHY-E

Sound Pressure Level (dBA)	H	M+	M	L+	L
	36	35	33	32	30

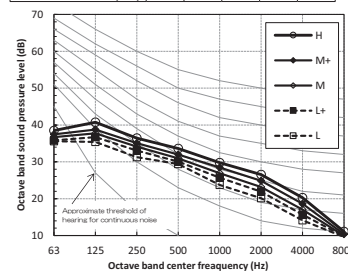

UP0271SPHY-E

Sound Pressure Level (dBA)	H	M+	M	L+	L
	37	36	34	33	32

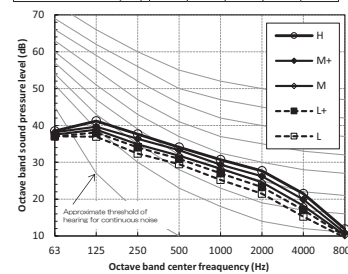

Accessories

No	Part name	Model name	Applied model	Remarks
1	Auxiliary fresh air flange	TCB-FF101URE2	MMD-UP___1SPHY-E	For fresh air intake by using the knockout hole of indoor unit (dia.=100 mm)

Slim duct connectors

CN32	CN60	CN61	CN70	CN73	CN80
Additional ventilation control from remote control	Operation status signal output (cooling, heating, fan, defrost, thermo-on)	External On/Off, operation output and alarm output	Warning symbol on remote control based on signal input. No IDU thermo off	Forced IDU thermo-off based on signal input	Forced IDU thermo-off and IDU lock based on signal input
•	TCB-PCUC2E pcb needed	•	TCB-PCUC2E pcb needed	TCB-PCUC2E pcb needed	TCB-PCUC2E pcb needed

Installation flexibility

Change from under air intake to back air intake

Under air intake

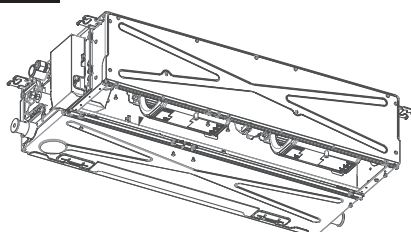

Back air intake

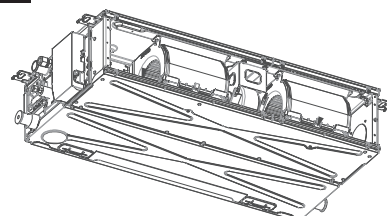

# MMD-UP\_HP HIGH STATIC PRESSURE DUCT

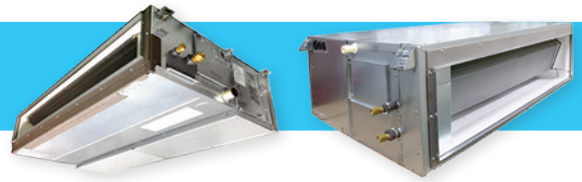

This is Toshiba's most powerful ducted unit delivering air flows up to 4,800 m<sup>3</sup>/h with an external static pressure up to 250 Pa.

CAPACITY



2 HP < 10 HP

SOUND PRESSURE LEVEL



37dB(A)

### OUTDOOR UNITS COMPATIBILITY

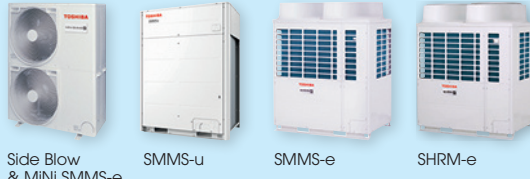

Side Blow & Mini SMMS-e

SMMS-u

SMMS-e

SHRM-e

### LOCAL CONTROLS



RBC-AXU31-E

RBC-ASCU11-E  
RBC-AMTU31-E  
RBC-AMSU51-EN/ES

## Features

Model name	MMD-	UP0181HP-E	UP0241HP-E	UP0271HP-E	UP0361HP-E	UP0481HP-E	UP0561HP-E	UP0721HP-E	UP0961HP-E	
Capacity code		2	2,5	3	4	5	6	8	10	
Cooling capacity	kW	5,6	7,1	8	11,2	14	16	22,4	28	
Heating capacity	kW	6,3	8	9	12,5	16	18	25	31,5	
Electrical characteristics	Power supply	1 phase 50Hz 230V(220V-240V) / 1 phase 60Hz 220V								
	Running current (A)	0,82	0,92	1,16	1,39	1,81	2,48	2,83	3,77	
	Power consumption (kW)	0,125	0,140	0,190	0,230	0,300	0,400	0,540	0,790	
	Starting current (A)	1,43	1,55	1,86	2,02	2,57	3,25	4,90	6,74	
Appearance		Zinc hot dipping steel plate								
Dimensions	HxLxP	mm	298x1000x750			298x1400x750		448x1400x900		
Total weight	kg		34			43		97		
Heat exchanger		Finned tube								
Soundproof / Heat-insulating material		Polyethylene foam								
Fan unit	Fan	Centrifugal fan								
	Standard air flow (High/Mid./Low)	m <sup>3</sup> /h	1100/990/900	1200/1050/960	1500/1350/1200	1920/1560/1340	2340/1980/1695	2760/2340/1920	3800/3200/2500	4800/4200/3500
	Motor output	W	250			350		250		
	External static pressure (factory setting)	Pa	100						150	
	External static pressure	Pa	50-75-125-150-175-200 (7steps)						50-83-117-150-183-217-250 (7steps)	
Sound pressure level (High/Med./Low)	dB(A)	37/33/31	38/34/31	43/41/38	41/37/34	44/41/38	46/44/41	44/40/36	46/42/38	
Sound power level (High/Med./Low)	dB(A)	60/54/50	60/55/51		62/57/53	65/62/54	68/64/56	79	81	
Controller		Remote controller								
Air filter		Sold separately (TCB-LK801D-E)			Sold separately (TCB-LK1401D-E)			Sold separately (TCB-LK2801D-E)		
Drain pump		Included						Sold separately (TCB-DP40DPE)		
Connecting Pipe	Gas side	inch	1/2"	5/8"	5/8"	5/8"	5/8"	5/8"	7/8"	7/8"
	Liquid side	inch	1/4"	3/8"	3/8"	3/8"	3/8"	3/8"	1/2"	1/2"
	Drain port	mm	25(Polyvinyl chloride tube)							

## Drawings

Unit: mm

### MMD-UP0181HP-E to MMD-UP0561HP-E

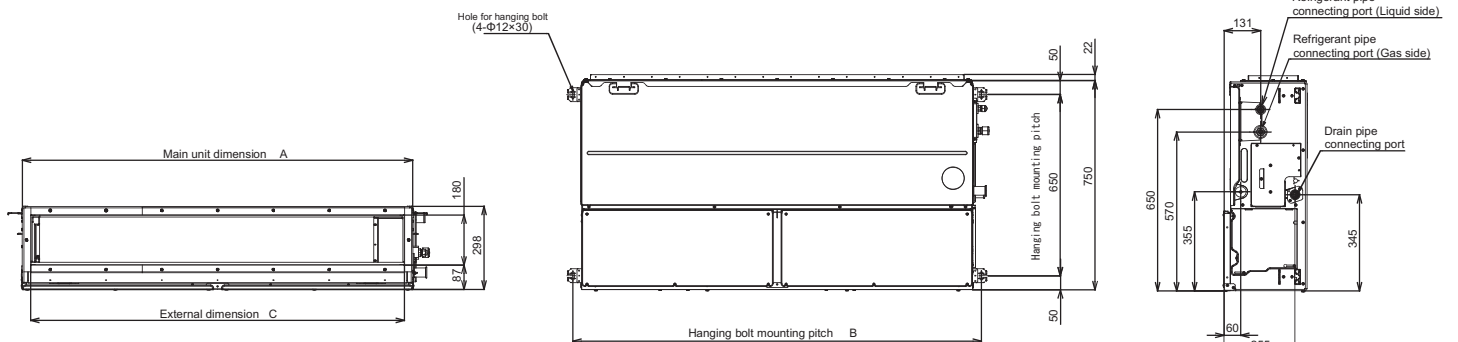

	A	B	C	D
MMD-AP0186-0276HP-E	1000	1065	940	500
MMD-AP0366-0566HP-E	1400	1465	1340	700

HIGH STATIC PRESSURE DUCT

Drawings

Unit: mm

MMD-UP0721HP-E & MMD-UP0961HP-E

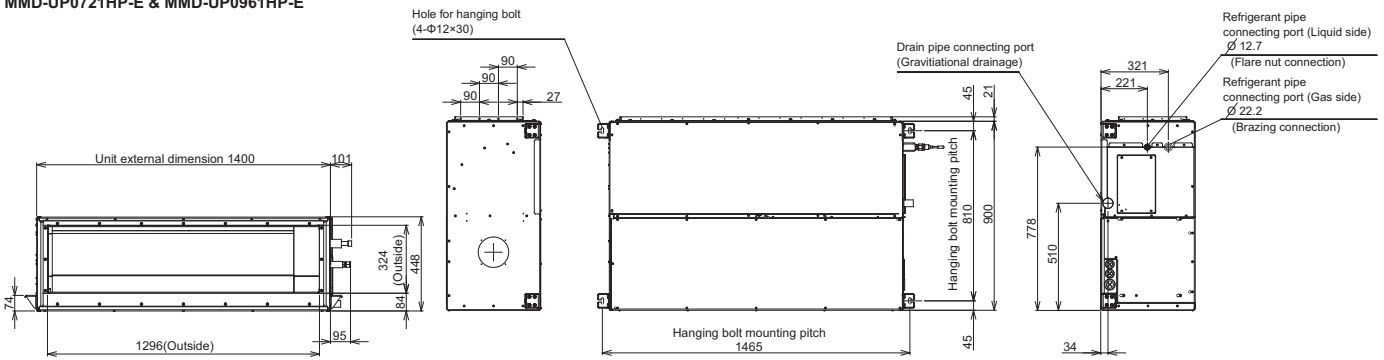

Sound pressure levels

Unit: dB(A)

MMD-UP0181HP-E

External static pressure 150Pa				
Fan tap	H	M	L	
Sound pressure (dBA)	41.0	36.0	33.0	

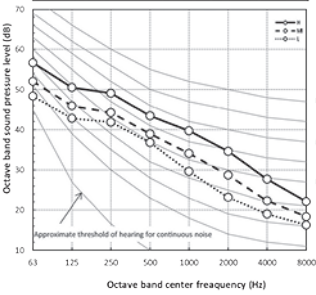

MMD-UP0241HP-E, MMD-UP0271HP-E

External static pressure 150Pa				
Fan tap	H	M	L	
Sound pressure (dBA)	42.0	37.0	34.0	

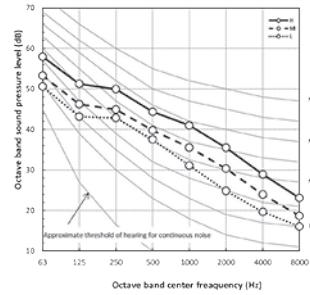

MMD-UP0361HP-E

External static pressure 150Pa				
Fan tap	H	M	L	
Sound pressure (dBA)	45.0	41.0	36.0	

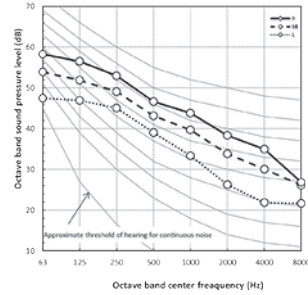

MMD-UP0481HP-E

External static pressure 150Pa				
Fan tap	H	M	L	
Sound pressure (dBA)	45.0	42.0	38.0	

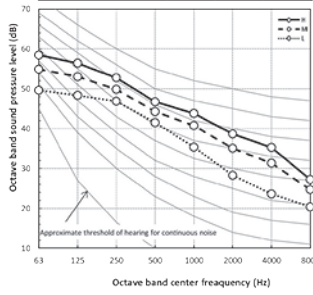

MMD-UP0561HP-E

External static pressure 150Pa				
Fan tap	H	M	L	
Sound pressure (dBA)	48.0	45.0	42.0	

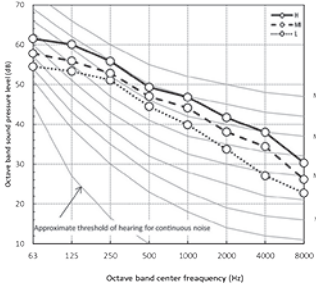

MMD-UP0721HP-E

External static pressure 150Pa				
Fan tap	H	M	L	
Sound pressure (dBA)	48.0	45.0	42.0	

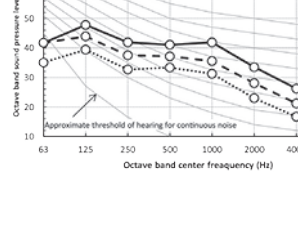

MMD-UP0961HP-E

External static pressure 150Pa				
Fan tap	H	M	L	
Sound pressure (dBA)	48.0	45.0	42.0	

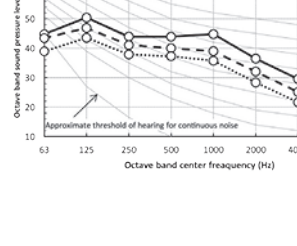

Accessories

Type	Model name	Applied model	Appearance	Remarks
Spigot shaped flange	TCB-SF80C6BE	MMD-UP0181/0241/0271HP-E		263x994x175mm / Spigot diameter 200mm
	TCB-SF160C6BE	MMD-UP0361/0481/0561HP-E		263x1394x175mm / Spigot diameter 200mm
Long life filter kit	TCB-LK801D-E	MMD-UP0181/0241/0271HP-E		Flange shaped Mount chassis directly Upside down mounting possible Left and right removable
	TCB-LK1401D-E	MMD-UP0361/0481/0581HP-E		
	TCB-LK2801DP-E	MMD-UP0721/0961HP-E		
Auxiliary fresh air flange	TCB-FF151US-E	UP0181/0241/0271/0361/0481/0581HP-E		
Drain pump kit	TCB-DP40DPE	MMD-AP0721/0961HP-E		

HSP duct connectors

	CN32	CN60	CN61	CN70	CN73	CN80
	Additional ventilation control from remote control	Operation status signal output (cooling, heating, fan, defrost, thermo-on)	External On/Off, operation output and alarm output	Warning symbol on remote control based on signal input. No IDU thermo off.	Forced IDU thermo-off based on signal input	Forced IDU thermo-off and IDU lock based on signal input
Up to 6HP	•	•	•	•	•	•
8 & 10HP	•	TCB-PCUC2E pcb needed	•	TCB-PCUC2E pcb needed	TCB-PCUC2E pcb needed	TCB-PCUC2E pcb needed



# MMC-UP\_HP UNDER CEILING



The simple, yet elegant design helps to create a pleasant and relaxing environment, quickly conditioning the room air to the desired temperature.

**CAPACITY**  
↑  
1.7 HP > 6 HP

**SOUND PRESSURE LEVEL**  
🔊  
28 dB(A)

### OUTDOOR UNITS COMPATIBILITY

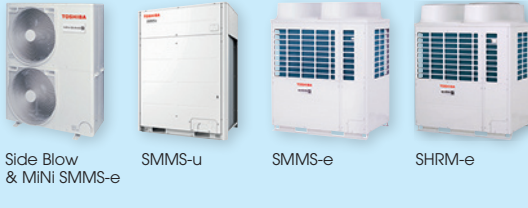

### LOCAL CONTROLS

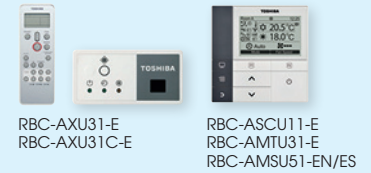

### Features

Model name	MMC-	UP0151HP-E	UP0181HP-E	UP0241HP-E	UP0271HP-E	UP0361HP-E	UP0481HP-E	UP0561HP-E	
Capacity code	HP	1,7	2	2,5	3	4	5	6	
Cooling capacity	kW	4,5	5,6	7,1	8	11,2	14	16	
Heating capacity	kW	5	6,3	8	9	12,5	16	18	
Electrical characteristics	Power supply	kW							1 phase 50Hz 230V (220-240V) / 1 phase 60Hz 220V
	Running current (50/60 Hz)	A	0.36/0.37	0.37/0.38	0.65/0.67	0.65/0.67	0.77/0.80	0.77/0.80	0.99/1.02
	Power consumption H/L	kW	0,033/0,014	0,034/0,014	0,067/0,018	0,067/0,018	0,083/0,024	0,083/0,031	0,111/0,035
	Starting current (50/60 Hz)	A	0.54/0.55	0.55/0.57	0.97/1.00	0.97/1.00	1.16/1.20	1.16/1.20	1.49/1.53
Appearance		Pure White (Munsell N9.1)							
Dimensions	HxLxP	mm	235x950x690		235x1270x690		235x1586x690		
Total weight	kg		23		29		35		
Heat exchanger		Finned tube							
Soundproof/Heat-insulating material		Polyethylene foam							
Fan unit		Centrifugal fan (Sirocco fan)							
Standard air flow	High	m <sup>3</sup> /h	840	960	1440	1440	1860	1860	2040
	Mid.	m <sup>3</sup> /h	690	720	1020	1020	1350	1530	1650
	Low	m <sup>3</sup> /h	540	540	750	750	1020	1200	1260
Motor output	W	94							
Sound pressure level (High/Mid/Low)	dBA	36/34/28	37/35/28	41/36/29	41/36/29	44/38/32	44/41/35	46/42/36	
Sound power level (High)	dBA	51	52	56	56	59	59	61	
Air filter		Standard filter (Long life filter)							
Controller		Remote controller							
Room thermostat		Attached							
Connecting pipe	Gas side	inch	1/2"	1/2"	5/8"	5/8"	5/8"	5/8"	5/8"
	Liquid side	inch	1/4"	1/4"	3/8"	3/8"	3/8"	3/8"	3/8"
	Drain port	mm	20 (Polyvinyl chloride tube)						

### Drawings

Unit: mm

MMC-UP0151HP-E, MMC-UP0181HP-E

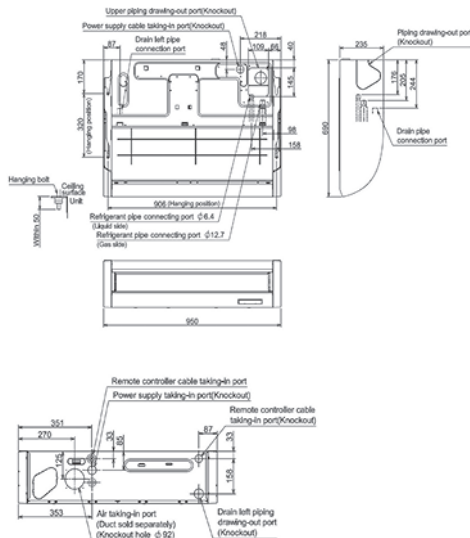

MMC-UP0241HP-E, MMC-UP0271HP-E

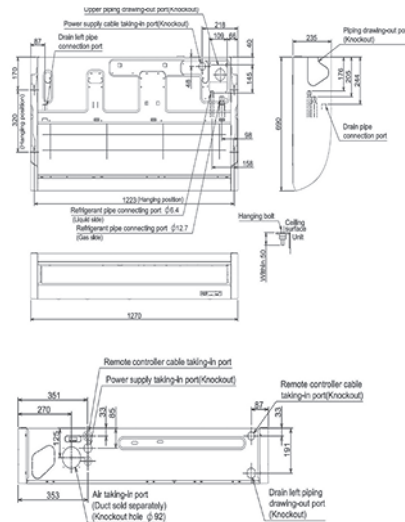

MMC-UP0361HP-E to MMC-UP0561HP-E

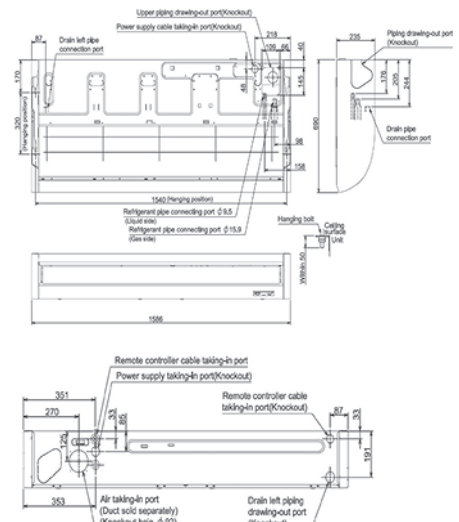

### Sound pressure levels

Unit: dB(A)

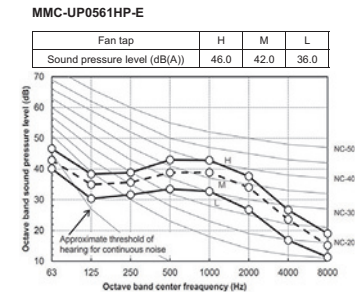
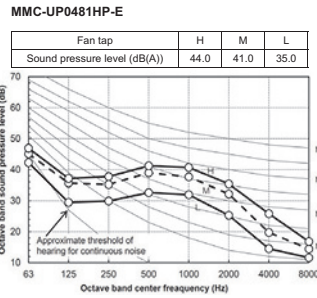
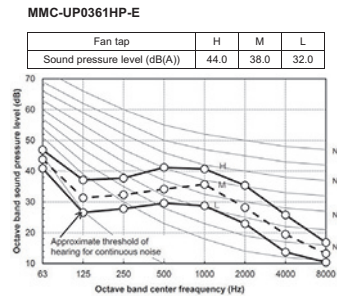
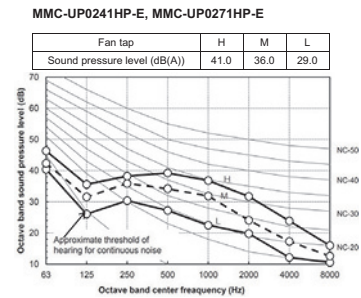
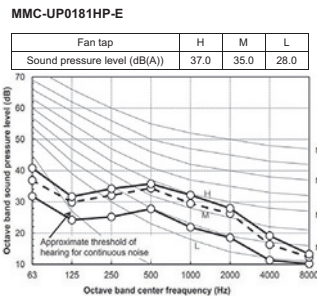
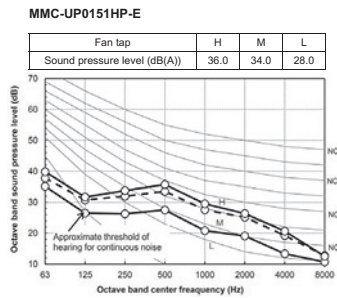

### Air diffusion

Unit: m/s

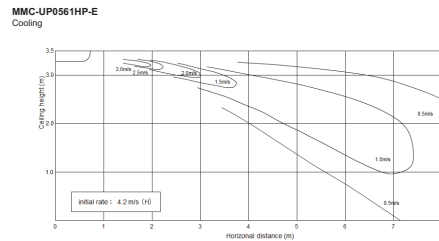
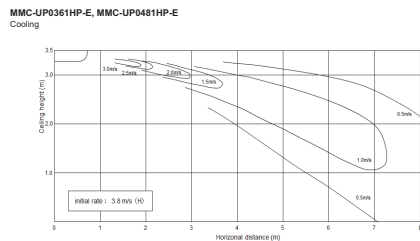
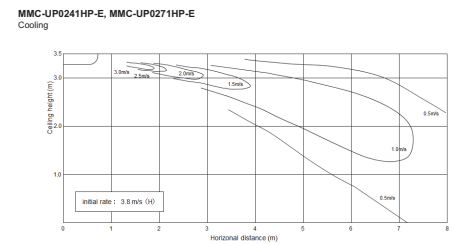
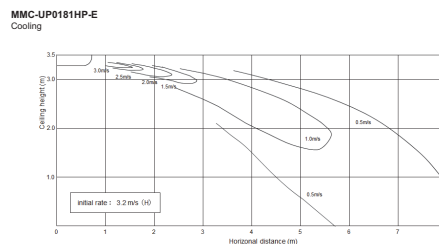
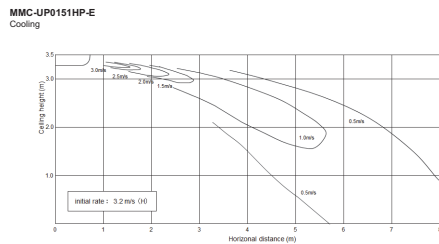

### Accessories

No	Part name	Model name	Applied model	Feature	Remark
1	Wireless Remote Controller kit	RBC-AXU31C-E	MMC-UP0151 to 0561HP-E	-	
2	Drain pump kit	TCB-DP31CE	MMC-UP0151 to 0561HP-E	Antibacterial glass is built into drain pump kit	
3	Elbow piping kit	TCB-KP14CPE	MMC-UP0151 to 0181HP-E	It is necessary for installation of drain pump kit	Use with TCB-DP31CE
		TCB-KP24CPE	MMC-UP0241 to 0561HP-E		
4	Option connecting kit	TCB-PCUC2E	MMC-UP0151 to 0561HP-E	For external I/O signal without local relay preparation	

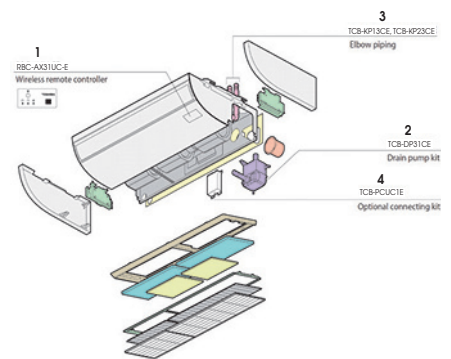

### Ceiling connectors

CN32	CN60	CN61	CN70	CN73	CN80
Additional ventilation control from remote control	Operation status signal output (cooling, heating, fan, defrost, thermo-on)	External On/Off, operation output and alarm output	Warning symbol on remote control based on signal input. No IDU thermo off.	Forced IDU thermo-off based on signal input	Forced IDU thermo-off and IDU lock based on signal input
•	TCB-PCUC2E pcb needed	•	TCB-PCUC2E pcb needed	TCB-PCUC2E pcb needed	TCB-PCUC2E pcb needed



# MML-UP\_NH BI-FLOW CONSOLE



Innovative and compact unit to be installed on the floor and in low wall applications, fits perfectly under the window sills or in a low ceiling attic.

CAPACITY



0.8 HP < 2 HP

SOUND PRESSURE LEVEL



26dB(A)

### OUTDOOR UNITS COMPATIBILITY



Side Blow & Mini SMMS-e

SMMS-u

SMMS-e

SHRM-e

### LOCAL CONTROLS



Included



RBC-ASCU11-E  
RBC-AMTU31-E  
RBC-AMSU51-EN/ES

## Features

Model name	MML-	UP0071NH-E	UP0091NH-E	UP0121NH-E	UP0151NH-E	UP0181NH-E		
Capacity code	HP	0.8	1	1.3	1.5	2		
Cooling capacity	kW	2,2	2,8	3,6	4,5	5,6		
Heating capacity	kW	2,5	3,2	4	5	6,3		
Electrical characteristics	Power supply	1 phase 50Hz 220-240V / 1 phase 60Hz 220V (Separate power supply for indoor units is required.)						
	Running current	50 Hz	A	0.20	0.20	0.23	0.29	0.42
		60 Hz	A	0.17	0.17	0.19	0.25	0.36
	Power consumption	H/L	kW	0.021/0.010	0.021/0.010	0.025/0.012	0.034/0.015	0.052/0.17
Starting current	A	0.26 / 0.22	0.26 / 0.22	0.30 / 0.25	0.38 / 0.33	0.55 / 0.47		
Appearance	Air intake grille and side panel	Moon white (Munsell : 2.5GY 9.0/0.5)						
	Discharge-grille	Moon white (Munsell : 2.5GY 9.0/0.5)						
	Bottom surface	Moon white (Munsell : 2.5GY 9.0/0.5)						
Dimensions	HxLxP	mm						
Weight	kg	17						
Heat exchanger		Finned tube						
Soundproof / Heat-insulating material		Foamed polystyrene. Polyethylene						
Fan		Turbo fan						
Motor output	(W)	41						
Air flow	High	(m³/h)	510	510	552	624	726	
	Mid.	(m³/h)	366	366	408	468	528	
	Low	(m³/h)	282	282	324	384	426	
Sound pressure level (High/Mid./Low)	dB(A)	38 / 32 / 26	38 / 32 / 26	40 / 34 / 29	43 / 37 / 31	47 / 40 / 34		
Sound power level (High)	dB(A)	53	53	55	59	62		
Air filter		Standard filter attached						
Controller		Wireless remote controller (packed with indoor unit)						
Connecting pipe	Gas side	inch	3/8"	3/8"	3/8"	1/2"	1/2"	
	Liquid side	inch	1/4"	1/4"	1/4"	1/4"	1/4"	
	Drain port (Nominal dia.)	mm	16 (Polypropylene tube)					

## Drawings

Unit: mm

### All models

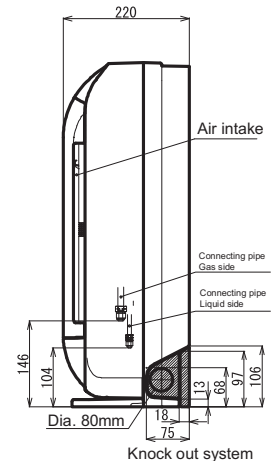
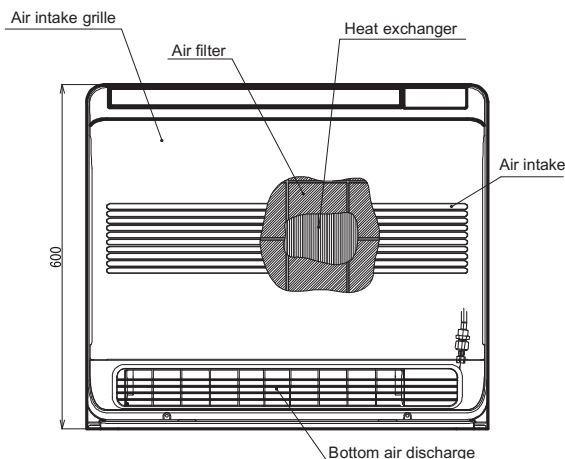
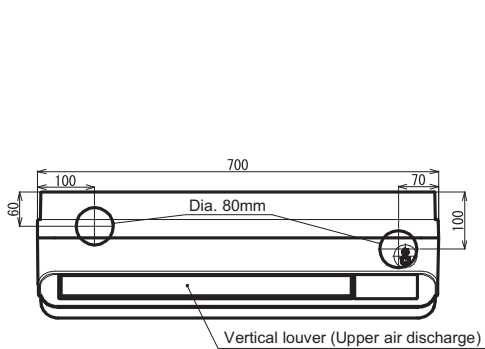



### Sound pressure levels

Unit: dB(A)

**MML-UP0071NH-E, UP0091NH-E**

Fan tap	H	M	L
Sound pressure level (dB(A))	38	32	26

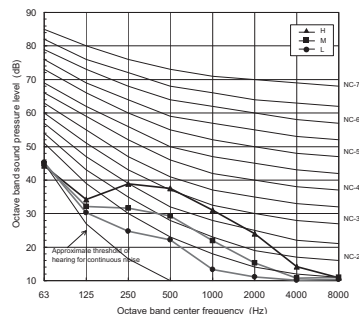

**MML-UP0121NH-E**

Fan tap	H	M	L
Sound pressure level (dB(A))	40	34	29

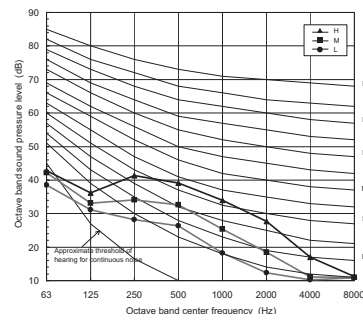

**MML-UP0151NH-E**

Fan tap	H	M	L
Sound pressure level (dB(A))	43	37	31

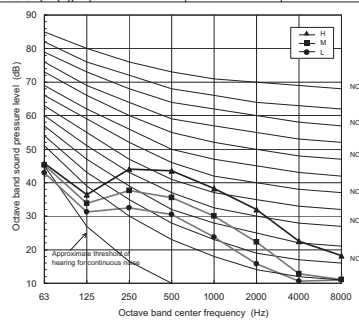

**MML-UP0181NH-E**

Fan tap	H	M	L
Sound pressure level (dB(A))	47	40	34

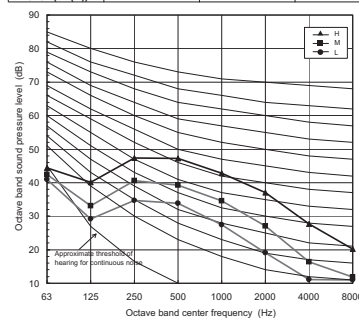

### Air diffusion

Unit: m/s

**MML-UP0071NH-E, UP0091NH-E**

**Cooling - Upper & Lower**

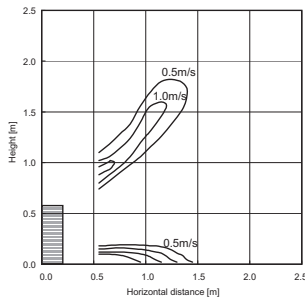

**Heating - Upper & Lower**

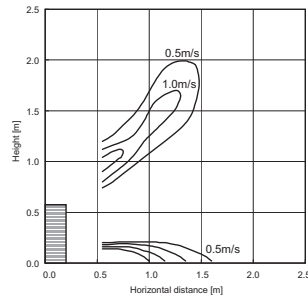

**MML-UP0121NH-E**

**Cooling - Upper & Lower**

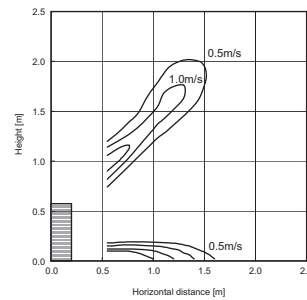

**Heating - Upper & Lower**

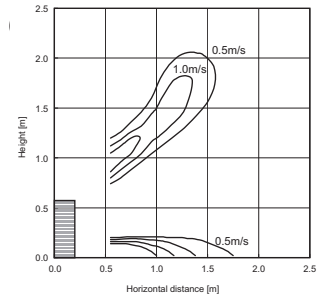

**MML-UP0151NH-E**

**Cooling - Upper & Lower**

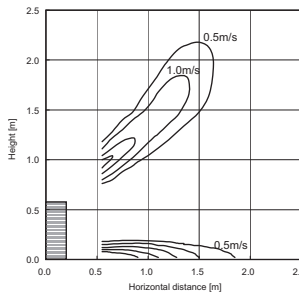

**Heating - Upper & Lower**

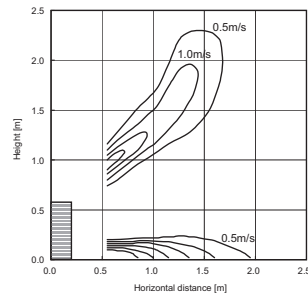

**MML-UP0181NH-E**

**Cooling - Upper & Lower**

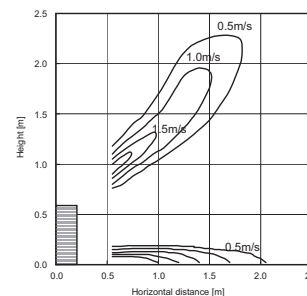

**Heating - Upper & Lower**

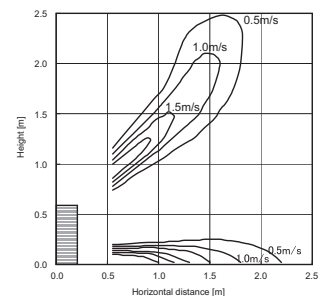

### Bi-flow console connectors



CN32	CN60	CN61	CN70	CN73	CN80
Additional ventilation control from remote control	Operation status signal output (cooling, heating, fan, defrost, thermo-on)	External On/Off, operation output and alarm output	Warning symbol on remote control based on signal input. No IDU thermo off.	Forced IDU thermo-off based on signal input	Forced IDU thermo-off and IDU lock based on signal input
•	•	•	-	-	•





The simple design of this unit represents the perfect choice, for refurbishment projects, where the available space is limited, or where neither the walls nor ceiling are able to house the unit.

CAPACITY      SOUND PRESSURE LEVEL

**0.8 HP < 2.5 HP**      **35dB(A)**

**OUTDOOR UNITS COMPATIBILITY**



Side Blow & Mini SMMS-e    SMMS-u    SMMS-e    SHRM-e

**LOCAL CONTROLS**



RBC-AXU31-E    RBC-ASCU11-E  
RBC-AMTU31-E    RBC-AMSU51-EN/ES

**Features**

Model name	MML-	UP0071H-E	UP0091H-E	UP0121H-E	UP0151H-E	UP0181H-E	UP0241H-E	
Capacity code	HP	0.8	1	1.3	1.7	2	2.5	
Cooling capacity	kW	2,2	2,8	3,6	4,5	5,6	7,1	
Heating capacity	kW	2,5	3,2	4	5	6,3	8	
<b>Electrical characteristics</b>	Power supply	1 phase 50Hz 220-240V / 1 phase 60Hz 220V (Separate power supply for indoor units is required.)						
	Running current	50 Hz	A		0,26		0,43	
		60 Hz	A		0,25		0,44	
	Power consumption	kW	0,056 / 0,044		0,092 / 0,069		0,102 / 0,076	
	Power factor	%	94 / 96		93 / 95		94 / 97	
Starting current	A	0,60		0,80		1,10		
<b>Appearance</b>		Silky shade (1Y8.5/0.5)						
Outer dimension	HxLxP mm	630x950x230						
Total weight	kg	37				40		
Heat exchanger		Finned tube						
Soundproof/Heat-insulating material		Non-flammable insulation						
<b>Fan unit</b>	Fan	Centrifugal fan						
	Standard air flow (High/Mid./Low)	m³/h	480 / 420 / 360		900 / 780 / 650		1,080 / 930 / 780	
	Motor output	W	45		70			
Sound pressure level (High/Mid./Low)	dB(A)	39 / 37 / 35		45 / 41 / 38		49 / 44 / 39		
Sound power level (High)	dB(A)	54		60		64		
Air filter		Standard filter (Simple filter)						
Controller		Remote controller						
<b>Connecting pipe</b>	Gas side	inch	3/8"	3/8"	3/8"	1/2"	1/2"	5/8"
	Liquid side	inch	1/4"	1/4"	1/4"	1/4"	1/4"	3/8"
	Drain port (Nominal dia.)	mm	20 (Polyvinyl chloride tube)					

**Drawings**

Unit: mm

All models

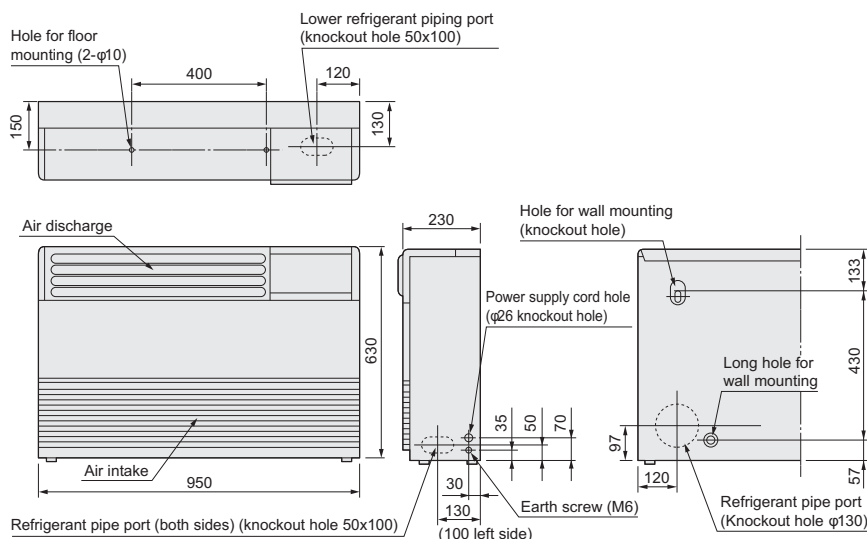

### Sound pressure levels

Unit: dB(A)

MML-UP0071H-E, UP0091H-E

Fan tap	H	M	L
Sound pressure level (dB(A))	39	37	35

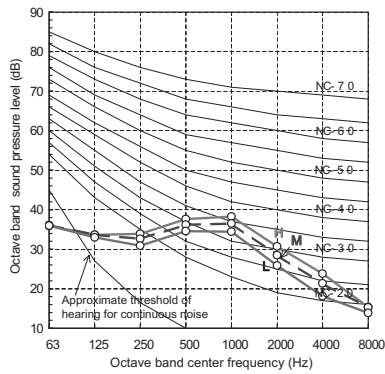

MML-UP0121H-E, UP0151H-E

Fan tap	H	M	L
Sound pressure level (dB(A))	45	41	38

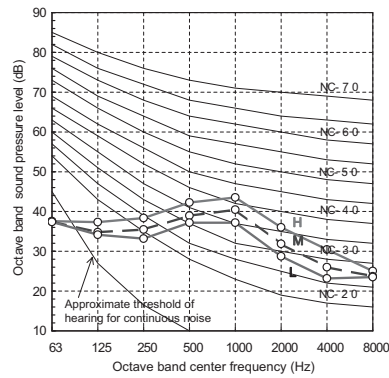

MML-UP0181H-E, UP0241H-E

Fan tap	H	M	L
Sound pressure level (dB(A))	49	44	39

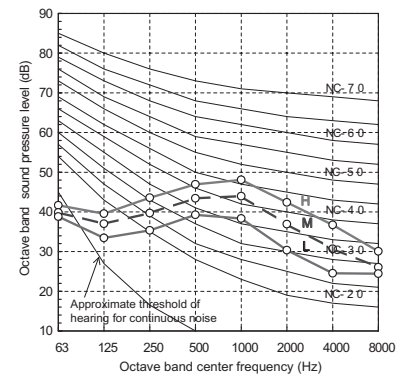

### Air diffusion

Unit: m/s

MML-UP0071H-E, UP0091H-E

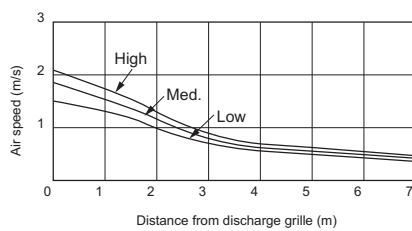

MML-UP0121H-E, UP0151H-E

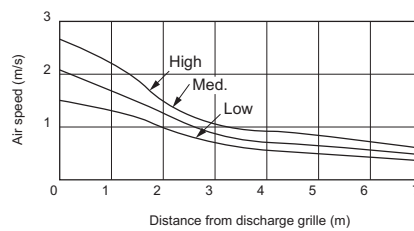

MML-UP0181H-E, UP0241H-E

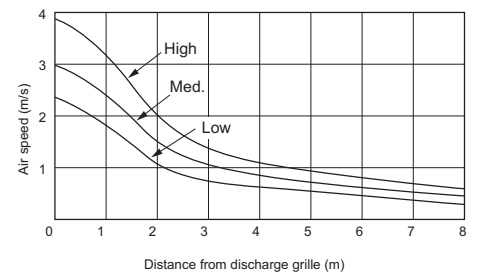

### Console connectors

CN32	CN60	CN61	CN70	CN73	CN80
Additional ventilation control from remote control	Operation status signal output (cooling, heating, fan, defrost, thermo-on)	External On/Off, operation output and alarm output	Warning symbol on remote control based on signal input. No IDU thermo off.	Forced IDU thermo-off based on signal input	Forced IDU thermo-off and IDU lock based on signal input
•	•	•	•	•	•

# MML-UP\_BH CONCEALED CONSOLE



This slim unit is designed to easily fit into a compact space and to perfectly integrate itself behind a decorative panel. This is the ideal unobtrusive solution that blends into any interior

### OUTDOOR UNITS COMPATIBILITY



Side Blow & Mini SMMS-e    SMMS-u    SMMS-e    SHRM-e

### LOCAL CONTROLS



RBC-AXU31-E    RBC-ASCU11-E  
RBC-AMTU31-E    RBC-AMSU51-EN/ES

CAPACITY    SOUND PRESSURE LEVEL



0.8 HP < 2.5 HP

32dB(A)

### Features

Model name	MML-	UP0071BH-E	UP0091BH-E	UP0121BH-E	UP0151BH-E	UP0181BH-E	UP0241BH-E	
Capacity code	HP	0.8	1	1.3	1.7	2	2.5	
Cooling capacity	kW	2,2	2,8	3,8	4,5	5,6	7,1	
Heating capacity	kW	2,5	3,2	4	5	6,3	8	
Power supply		1 phase 50Hz 200-240V / 1 phase 60Hz 220V (Separate power supply for indoor units is required.)						
Electrical characteristics	Running current	50 Hz	A	0,25		0,45		
				60 Hz	0,27		0,46	
	Power consumption H/L	50 Hz	kW	0.056/0.039		0.090/0.062		
				60 Hz	0.058/0.041		0.096/0.068	
	Power factor	50 Hz	97		87		90	
Starting current	60 Hz	98		95		98		
Appearance		Zinc hot dipping steel plate						
Dimensions	HxLxP	mm				600x745x220		600x1075x220
Weight	kg	21				29		
Heat exchanger		Finned tube						
Soundproof/Heat-insulating material		Non-flammable insulation						
Fan unit	Fan	Centrifugal fan						
	Standard air flow (High/Mid./Low)	m <sup>3</sup> /h	460 / 400 / 300		740 / 600 / 490		950 / 790 / 640	
	Motor output	W	19		70			
	Static pressure	Pa	0					
Air filter		Standard filter (Simple feter)						
Controller		Remote controller						
Connecting pipe	Gas side	inch	3/8"	3/8"	3/8"	1/2"	1/2"	5/8"
	Liquid side	inch	1/4"	1/4"	1/4"	1/4"	1/4"	3/8"
	Drain port (Nominal dia.)	mm	20 (One side of male screw)					
Sound pressure level (High/Mid./Low)	dB(A)	36 /34/32				42 /37/33		
Sound power level (High)	dB(A)	54				60		

### Drawings

Unit: mm

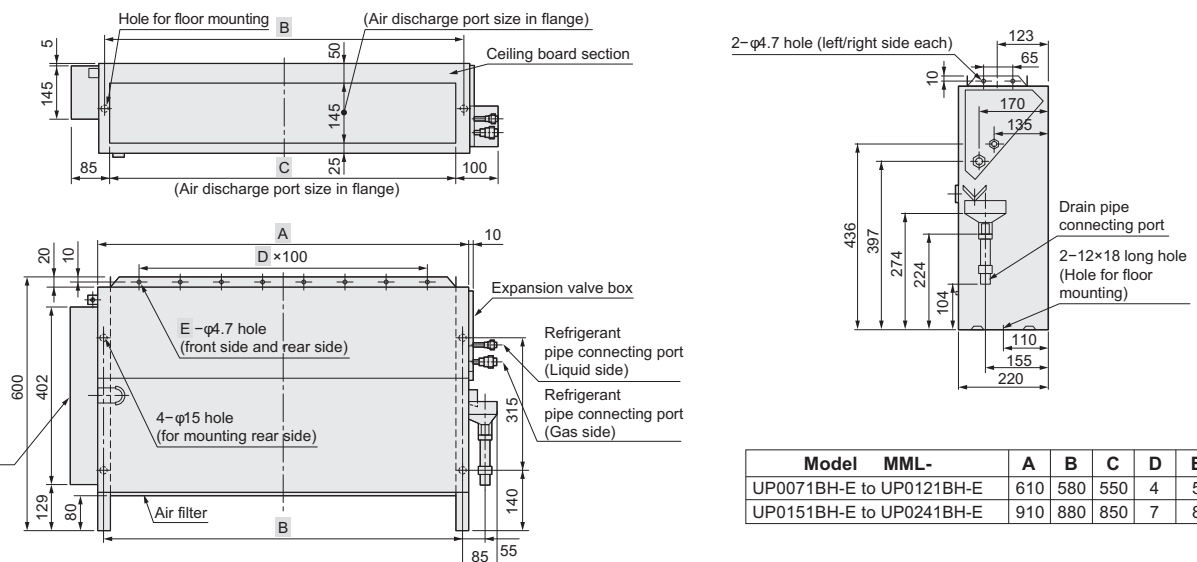

Model	MML-	A	B	C	D	E
UP0071BH-E to UP0121BH-E		610	580	550	4	5
UP0151BH-E to UP0241BH-E		910	880	850	7	8

**Sound pressure levels**

Unit: dB(A)

**MML-UP0071BH-E to MML-UP0121BH-E**

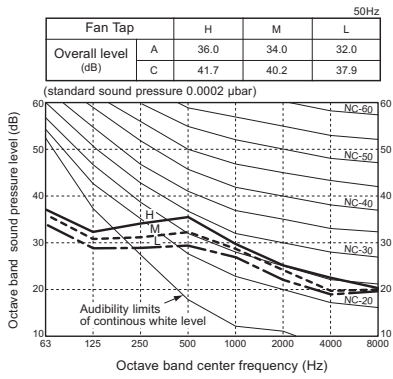

**MML-UP0151BH-E, MML-UP0181BH-E**

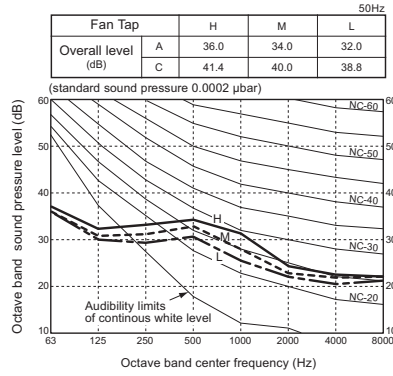

**MML-UP0241BH-E**

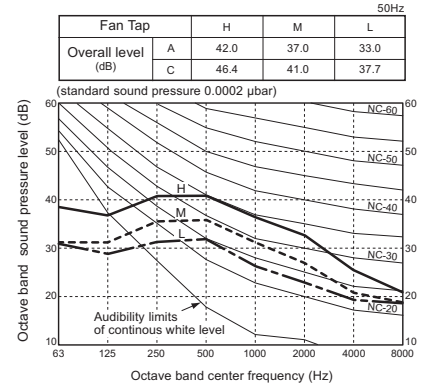

**Concealed chassis embedded connectors**

CN32	CN60	CN61	CN70	CN73	CN80
Additional ventilation control from remote control	Operation status signal output (cooling, heating, fan, defrost, thermo-on)	External On/Off, operation output and alarm output	Warning symbol on remote control based on signal input. No IDU thermo off.	Forced IDU thermo-off based on signal input	Forced IDU thermo-off and IDU lock based on signal input
•	•	•	•	•	•

# MMF-UP\_H FLOOR STANDING



This system is particularly suitable to air condition large rooms like shops or showrooms or with low ceilings like restaurants or lofts.

**CAPACITY**  
↑  
1.7 HP < 6 HP

**SOUND PRESSURE LEVEL**  
🔊  
37dB(A)

### OUTDOOR UNITS COMPATIBILITY

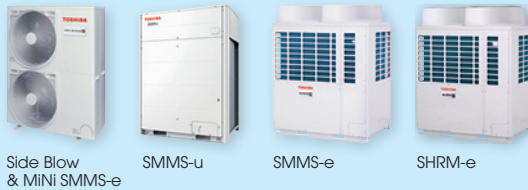

### LOCAL CONTROLS



## Features

Model name	MMF-	UP0151H-E	UP0181H-E	UP0241H-E	UP0271H-E	UP0361H-E	UP0481H-E	UP0561H-E	
Capacity code		1,7	2	2,5	3	4	5	6	
Cooling capacity	kW	4,5	4,6	7,1	8	11,2	14	16	
Heating capacity	kW	5	6,3	8	9	12,5	16	18	
Power supply	1 phase 50Hz 220-240V / 1 phase 60Hz 220V (Separate power supply for indoor units is required.)								
Electrical characteristics	Running current	50 Hz 60 Hz	A	0,38 0,40	0,60 0,63	0,90 0,94	1,10 1,15		
	Power consumption H/L	kW		0.055/0.026	0.089/0.034	0.135/0.052	0.160/0.074		
	Starting current	50 Hz 60 Hz	A	0,53 0,56	0,84 0,88	1,26 1,32	1,54 1,61		
	Appearance	Silky shade (Munsell / 1Y 8.5 / 8.0)							
Dimensions	HxLxP	mm	1750x600x210				1750x600x390		
Weight	kg		46		47		62		
Heat exchanger	Finned tube								
Soundproof/Heat-insulating material	Non-flammable insulation								
Fan unit	Fan	Centrifugal fan							
	Standard air flow (High/Mid./Low)	m³/h	900 / 780 / 660		1,200 / 990 / 840		1,920/1,620/1380		2,160 / 1,730 / 1,560
	Motor	W	62		62		109		
Air filter	Standard filter (Simple filter)								
Controller	Remote controller								
Connecting pipe	Gas side	inch	1/2"	1/2"	1/2"	1/2"	1/2"	1/2"	
	Liquid side	inch	1/4"	1/4"	1/4"	3/8"	3/8"	3/8"	
	Drain port (Nominal dia.)	mm	20 (One side of male screw)						
Sound pressure level (High/Mid./Low)	dB(A)	46 / 42 / 37		49 / 45 / 39		51 / 46 / 41		54 / 49 / 44	
Sound power level (High)	dB(A)	64		67		69		72	

## Drawings

Unit: mm

### MMF-UP0151H-E to MMF-UP0271H-E

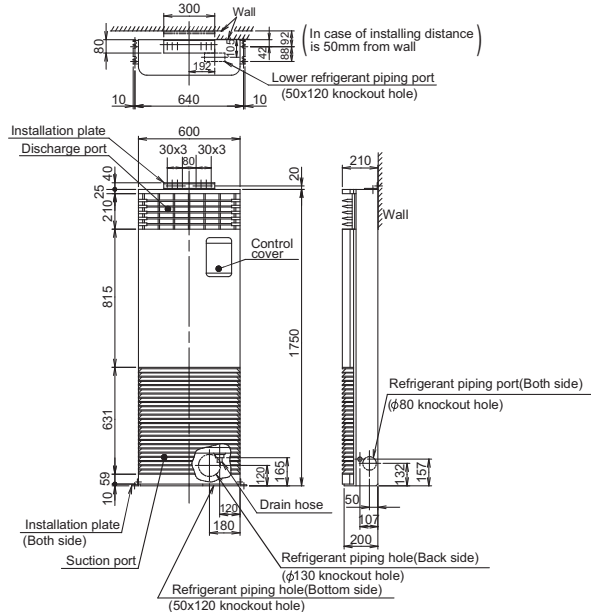

### MMF-UP0361H-E to MMF-UP0561H-E

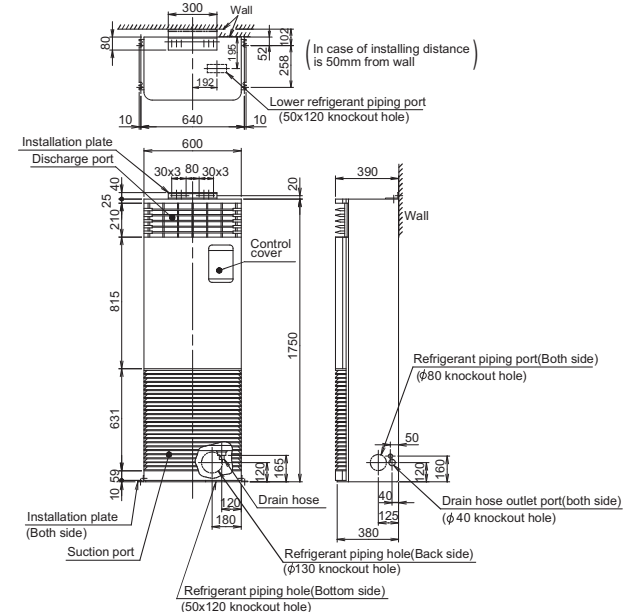

Sound pressure levels

Unit: dB(A)

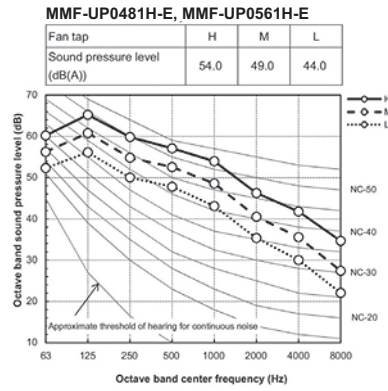
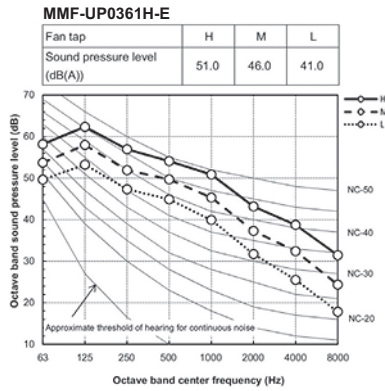
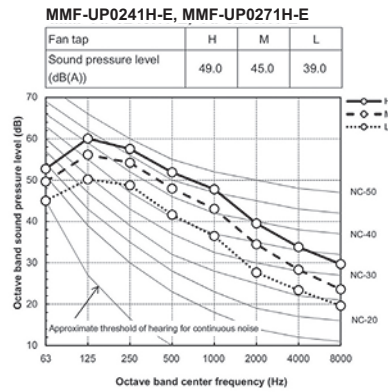
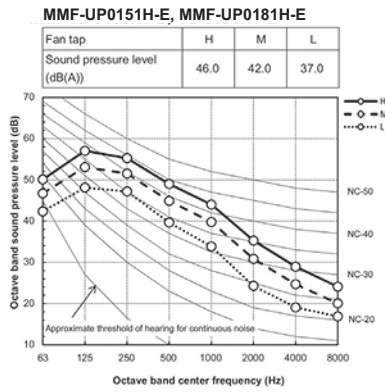

Air diffusion

Unit: m/s

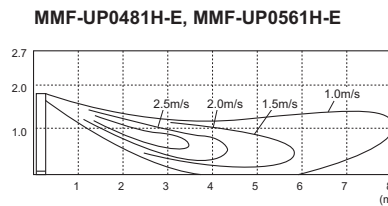
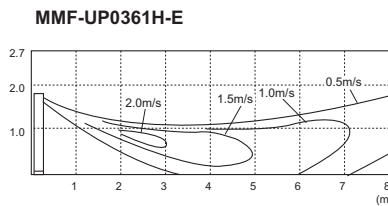
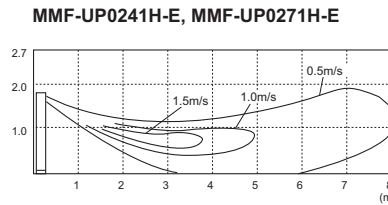
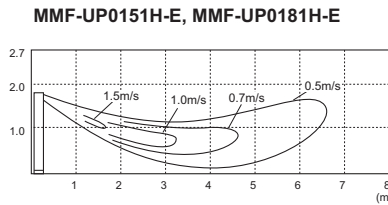

Floor standing embedded connectors

CN32	CN60	CN61	CN70	CN73	CN80
Additional ventilation control from remote control	Operation status signal output (cooling, heating, fan, defrost, thermo-on)	External On/Off, operation output and alarm output	Warning symbol on remote control based on signal input. No IDU thermo off.	Forced IDU thermo-off based on signal input	Forced IDU thermo-off and IDU lock based on signal input
•	TCB-PCUC2E pcb needed	•	TCB-PCUC2E pcb needed	TCB-PCUC2E pcb needed	TCB-PCUC2E pcb needed



MML-UP\_HP/HPL  
HIGH-WALL

> NEW 0.3HP SIZE



Particularly compact, this high-wall is perfect for limited spaces, such as offices or small shops.

CAPACITY



0.3 HP < 2.5 HP

SOUND PRESSURE LEVEL



25dB(A)

OUTDOOR UNITS COMPATIBILITY



LOCAL CONTROLS

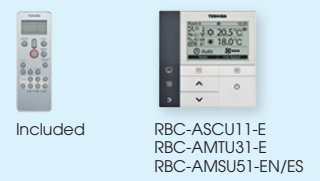

Features

Model name	Standard application	MMK-UP0031HP-E	MMK-UP0051HP-E	MMK-UP0071HP-E	MMK-UP0091HP-E	MMK-UP0121HP-E	MMK-UP0151HP-E	MMK-UP0181HP-E	MMK-UP0241HP-E	
	Low noise applications	MMK-UP0031HPL-E	MMK-UP0051HPL-E	MMK-UP0071HPL-E	MMK-UP0091HPL-E	MMK-UP0121HPL-E	MMK-UP0151HPL-E	MMK-UP0181HPL-E	MMK-UP0241HPL-E	
Capacity code		0,3	0,6	0,8	1	1,25	1,7	2	2,5	
Cooling capacity	kW	0,9	1,7	2,2	2,8	3,6	4,5	5,6	7,1	
Heating capacity	kW	1,3	1,9	2,5	3,2	4,0	5,0	6,3	8,0	
Electrical characteristics	Power supply	1 phase / 50Hz / 230V(220V-240V), 1 phase / 60 Hz / 220V (Separate power supply for indoor units is required.)								
	Running current	A	0,15	0,15	0,16	0,17	0,18	0,26	0,29	0,40
	Power consumption	kW	0,013	0,013	0,015	0,016	0,017	0,028	0,032	0,05
	Starting current	A	0,19	0,19	0,20	0,21	0,22	0,35	0,38	0,50
Dimensions	HxLxP	mm				293x798x230		320x1050x250		
Weight	kg	11				16				
Air Flow (H / M / L)	m³/h	455/370/270		480/385/270		510/395/270		540/410/270		840/690/550
Sound Pressure Level (H / M / L)	dB(A)	33/29/25		35/30/25		36/31/25		37/32/25		40/36/32
Sound Power Level (H)	dB(A)	48		50		51		52		55
Heat exchanger		Finned tube								
Soundproof/Heat-insulating material		Non-flammable insulation								
Fan		Cross Flow Fan								
Controller (Packed with unit)		WH-TA09NE								
Connecting pipe	Gas side	inch	1/2"	1/2"	1/2"	1/2"	1/2"	1/2"	1/2"	5/8"
	Liquid side	inch	1/4"	1/4"	1/4"	1/4"	1/4"	1/4"	1/4"	3/8"
Drain port diameter	mm	16 (Polyvinyl chloride tube)								

Drawings

Unit: mm

MMK-UP0031HP(L)-E to MMK-UP0121HP(L)-E

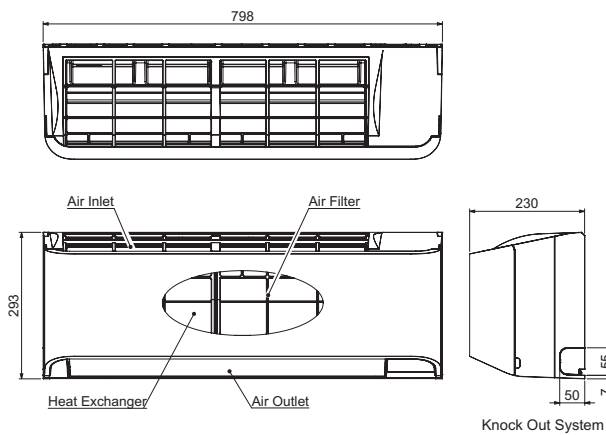

MMK-UP0151HP(L)-E to MMK-UP0241HP(L)-E

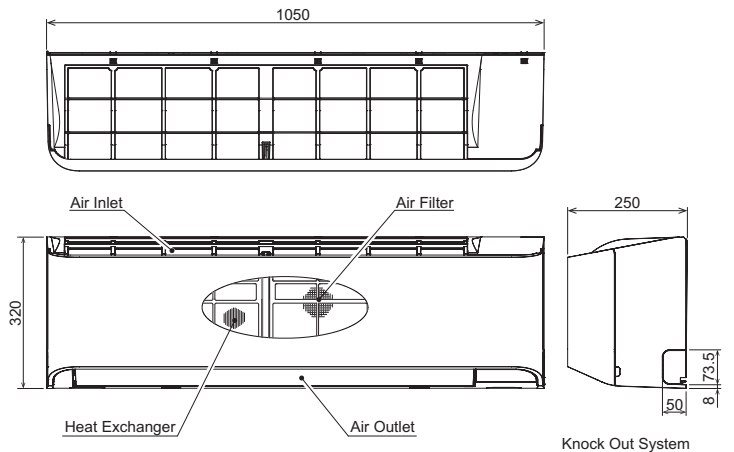



### Sound pressure levels

Unit: dB(A)

MMK-UP0031HP(L)-E, UP0051HP(L)-E

Sound pressure level(dB(A))	HH-HL
	35-31-28

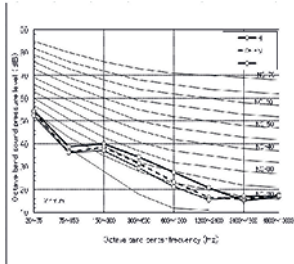

MMK-UP0071HP(L)-E

Sound pressure level(dB(A))	HH-HL
	37-32-28

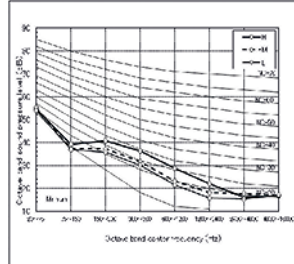

MMK-UP0091HP(L)-E

Sound pressure level(dB(A))	HH-HL
	41-36-33

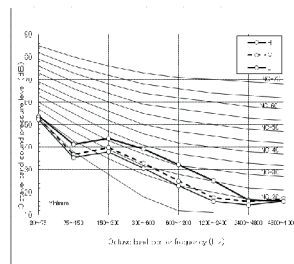

MMK-UP0121HP(L)-E

Sound pressure level(dB(A))	HH-HL
	46-39-34

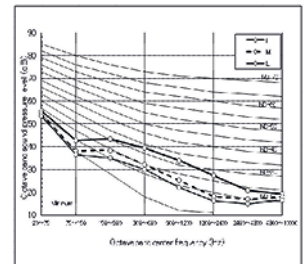

MMK-UP0151HP(L)-E

Cooling		Specification (d B)		
Fan tap		H	M	L
Sound pressure level (dB(A))		40	36	32

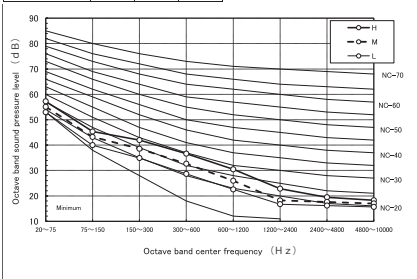

MMK-UP0181HP(L)-E

Cooling		Specification (d B)		
Fan tap		H	M	L
Sound pressure level (dB(A))		41	37	32

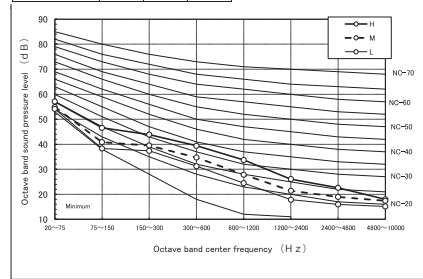

MMK-UP0241HP(L)-E

Cooling		Specification (d B)		
Fan tap		H	M	L
Sound pressure level (dB(A))		45	39	33

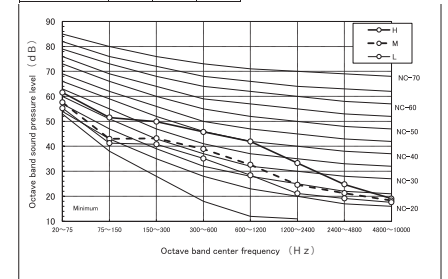

### Air diffusion

Unit: m/s

MMK-UP0031HP(L)-E

High wind : 3.8m/s  
Med wind : 2.8m/s  
Low wind : 2.5m/s

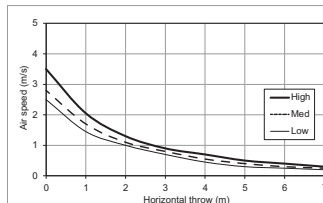

MMK-UP0071HP(L)-E

High wind : 3.9m/s  
Med wind : 3.0m/s  
Low wind : 2.5m/s

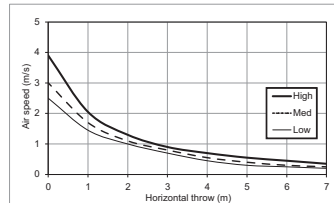

MMK-UP0091HP(L)-E

High wind : 4.1m/s  
Med wind : 3.2m/s  
Low wind : 2.5m/s

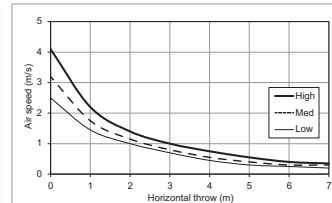

MMK-UP0121HP(L)-E

High wind : 4.3m/s  
Med wind : 3.4m/s  
Low wind : 2.5m/s

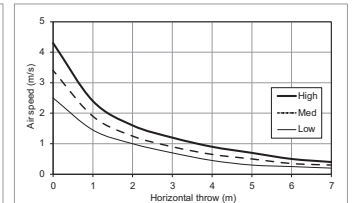

MMK-UP0151HP(L)-E

High wind : 4.6 m/s  
Med wind : 3.7 m/s  
Low wind : 2.8 m/s

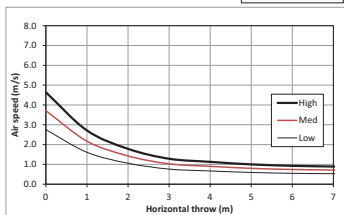

MMK-UP0181HP(L)-E

High wind : 5.0 m/s  
Med wind : 3.9 m/s  
Low wind : 2.8 m/s

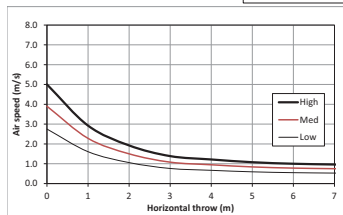

MMK-UP0241HP(L)-E

High wind : 6.5 m/s  
Med wind : 5.0 m/s  
Low wind : 3.1 m/s

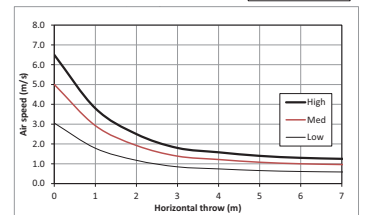

### Accessories

Type	Model name	Applied model	Appearance	Remarks
PMV Kit	RBM-PMV0301U-E	0.3 to 1.25HP high-wall		Needed for low noise application high wall
	RBM-PMV0901U-E	1.7 to 3.0HP high-wall		

### High wall embedded connectors

CN32	CN60	CN61	CN70	CN73	CN80
Additional ventilation control from remote control	Operation status signal output (cooling, heating, fan, defrost, thermo-on)	External On/Off, operation output and alarm output	Warning symbol on remote control based on signal input. No IDU thermo off.	Forced IDU thermo-off based on signal input	Forced IDU thermo-off and IDU lock based on signal input



# VN-M\_HE AIR-TO-AIR HEAT EXCHANGER

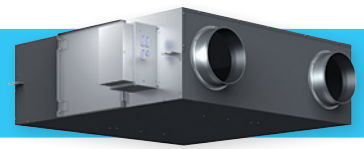

Toshiba's VN model uses exhaust air to pre-condition the incoming air, thus reducing the cooling or heating load on the system. This allows the overall capacity size of the system to be reduced.

AIR FLOW



150m<sup>3</sup>/h > 2,000m<sup>3</sup>/h

SOUND PRESSURE LEVEL



20dB(A)

### OUTDOOR UNITS COMPATIBILITY



Side Blow & MINI SMMS-e



SMMS-u



SMMS-e



SHRM-e

### LOCAL CONTROLS



NRC-01HE  
RBC-AMTU31-E

## Features

Item		VN-M150HE	VN-M250HE	VN-M350HE	VN-M500HE	VN-M650HE	VN-M800HE	VN-M1000HE1	VN-M1500HE1	VN-M2000HE1
Air volume (m <sup>3</sup> /h)	Extra high	150	250	350	500	650	800	1000	1500	2000
	High	150	250	350	500	650	800	1000	1500	2000
	Low	110	155	210	390	520	700	700	1200	1400
Power consumption (W)	Extra high	68-78	123-138	165-182	214-238	262-290	360-383	390	640	780
	High	59-67	99-111	135-145	176-192	240-258	339-353	340	570	680
	Low	42-47	52-59	82-88	128-142	178-191	286-300	190	320	380
External static pressure (Pa)	Extra high	82-102	80-98	114-125	134-150	91-107	142-158	105	140	105
	High	52-78	34-65	56-83	69-99	58-82	102-132	80	110	80
	Low	47-64	28-40	65-94	62-92	61-96	76-112	70	80	70
Sound pressure level (dB(A))	Extra high	26-28	29/5/30	34-35	32.5-34	34-36	37-38.5	38.0	41.0	41.5
	High	24-25.5	25-27	30-32	29/5/31	33-34	35.5-37	37.0	40.0	40.5
	Low	20-22	21-22	27-29	26-29	31-32.5	33.5-35	33.0	36.0	36.5
Sound power level (dB(A))	Extra high	41.0-43.0	44.5-45.0	49.0-50.0	47.5-49.0	49.0-51.0	52.0-53.5	53.0	56.0	56.5
	High	81.5	78	74.5	76.5	75	76.5	73.5	76.5	73.5
	Low	83	81.5	79.5	78	76.5	77.5	77.0	79.0	77.5
Temperature exchange efficiency (%)	Extra high	74.5	70	65	72	69.5	71	68.5	71.0	68.5
	High	74.5	70	65	72	69.5	71	68.5	71.0	68.5
	Low	76	74	71.5	73.5	71.5	71.5	71.5	73.5	72.0
Enthalpy exchange efficiency (%)	For heating	69.5	65	60.5	64.5	61.5	64	60.5	64.0	60.5
	High	69.5	65	60.5	64.5	61.5	64	60.5	64.0	60.5
	Low	71	69	67	66.5	64	65.5	64.5	67.0	65.5
Power supply (V)		220-240V- 50Hz								
Dimensions (LxWxH) (mm)		900 x 900 x 290			1140 x 1140 x 350			1189 x 1189 x 400		1189 x 1189 x 810
Weight (kg)		36	36	38	53	53	70	70	126	126
Duct diameter (mm)		100	150		200		250		Inside: 250	Outside: 283x730
Filtration efficiency grade (%)		82								
Operating range	Around unit	-10°C-40°C 80%RH or less								
	Outdoor Air (OA)	-15°C(*1)-43°C 80%RH or less								
	Return Air (RA)	5°C-40°C 80%RH or less								

\* Air volume can be changed over to high (Extra high) mode or low mode at both heat exchange and normal ventilation modes.  
 \* Sound pressure level is measured 1.5 m below the center of the unit, and the value which was measured at the acoustic room.  
 \* Sound pressure levels usually become higher than above values by the influence of actual installation condition such as reflected sound and peripheral noise.

\* Sound power level is the value of casing.  
 \*1) When the temperature of the outdoor air is below -10°C, the unit runs cold operation mode (intermittent operation of the ventilation for air supply).  
 The unit cannot be used at -15°C or less.  
 The ventilator for air supply stops, and the ventilator for air exhaust also can be stopped by the setting.

## Drawings

Unit: mm

VN-M150HE to VN-M350HE

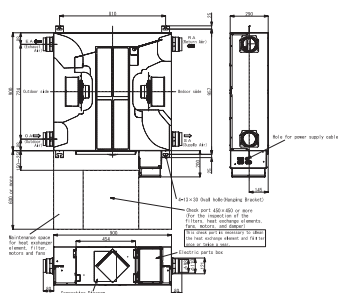

VN-M500HE & VN-M650HE\*

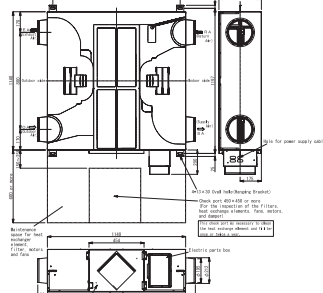

VN-M800HE & VN-M1000HE1

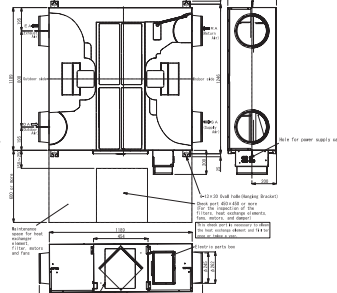

VN-M1500HE1 & VN-M2000HE1

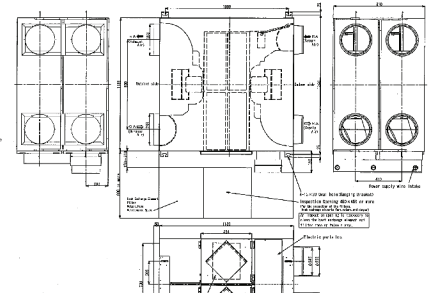

## AIR-TO-AIR HEAT EXCHANGER

### Sound pressure levels

Unit: dB(A)

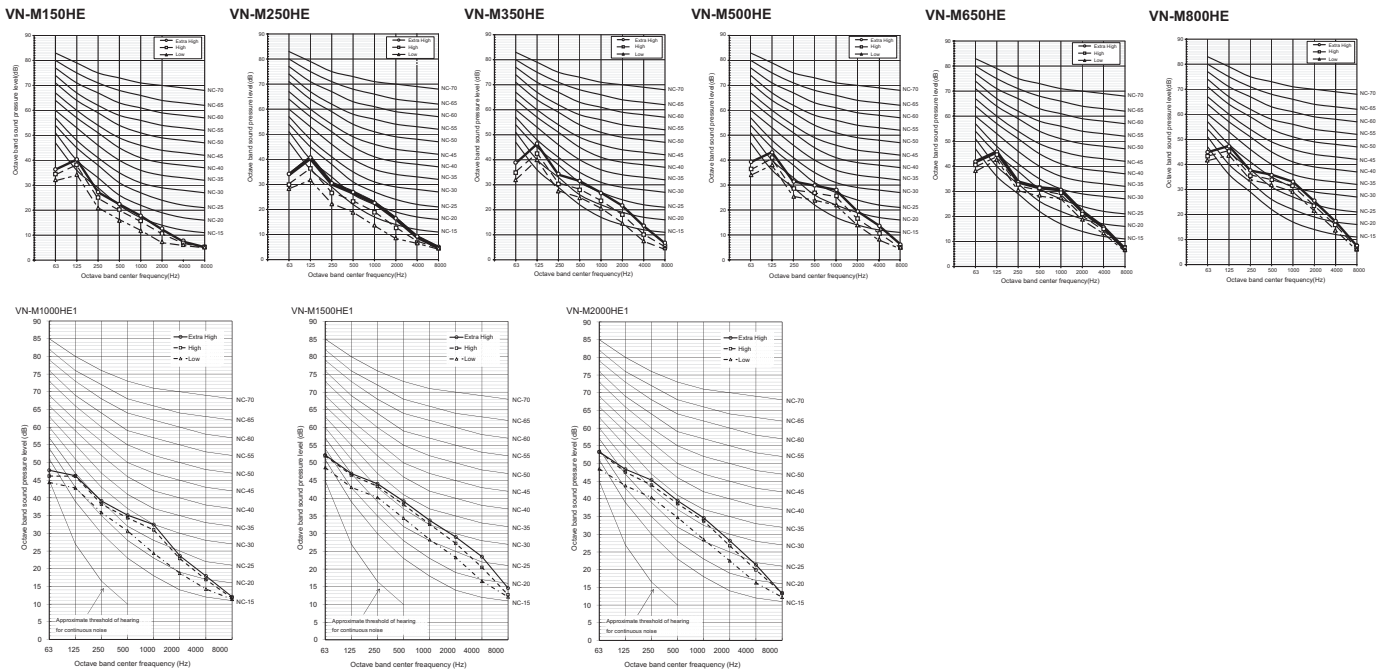

### Accessories

Type	Model name	Description	Appearance	Remarks
Control	NRC-01HE	All air-to-air heat exchangers dedicated remote control		Integrated functions : fan speed, freecooling, air balance volume rate, temperature management and timer.
	NRB-1HE	All air-to-air heat exchangers On/Off additional PCB		On/off optionnal PCB for air-to-air heat exchanger

### Other information

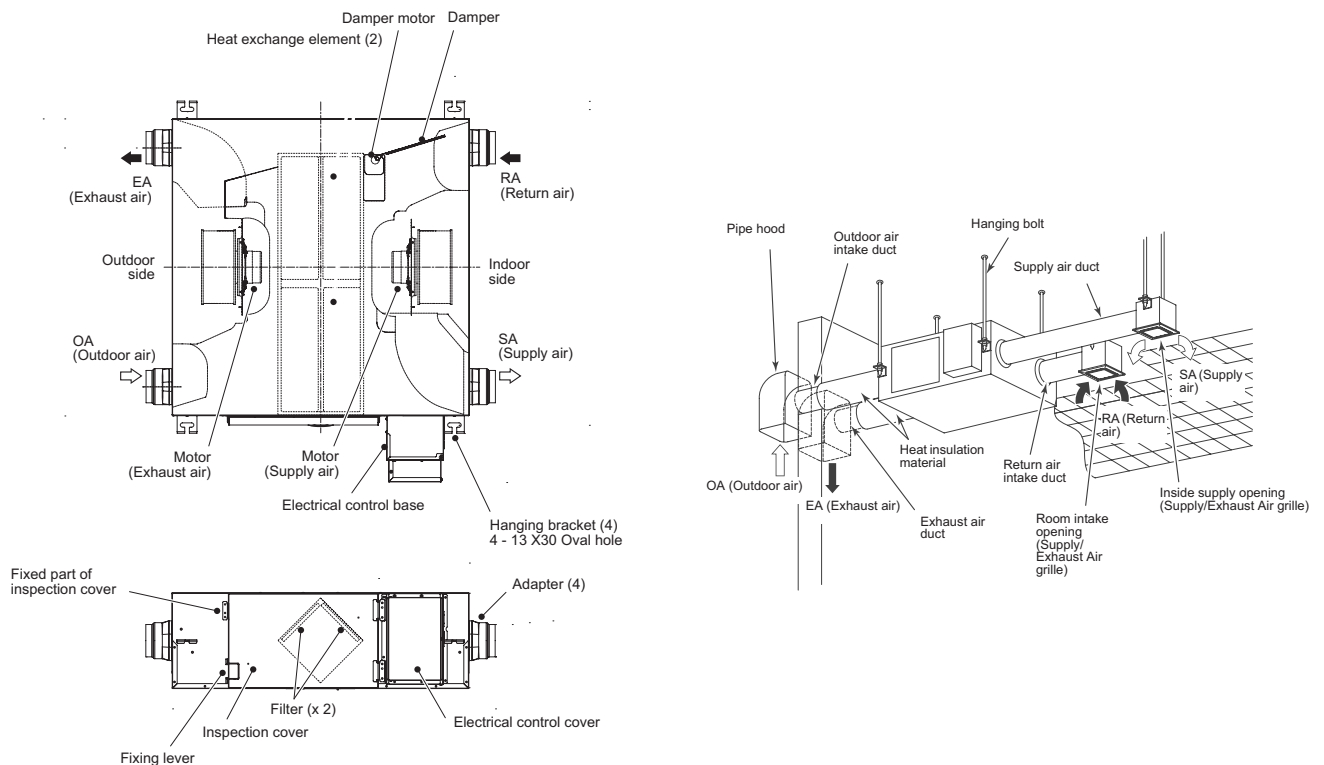



MMD-VN(K) ventilation products are using exhaust air + DX coil to pre-condition the incoming air, thus reducing the cooling or heating load and the overall size of the required air conditioning system.

CAPACITY



4.1kW >10.9kW

AIR FLOW



Up to 500m<sup>3</sup>/h > 1,000m<sup>3</sup>/h

SOUND PRESSURE LEVEL



34dB(A)

OUTDOOR UNITS COMPATIBILITY



Mini SMMS-e  
4, 5 & 6HP



SMMS-e



SHRM-e

LOCAL CONTROLS



NRC-01HE  
RBC-AMTU31-E

Features

Model name	MMD-	VN502HEX1E	Without humidifier			VNK502HEX1E	With humidifier			
Cooling Capacity	kW	4.10(1.30)	VN802HEX1E	6.56(2.06)	VN1002HEX1E	8.25(2.32)	VNK802HEX1E	6.56(2.06)	VNK802HEX1E	8.25(2.32)
Heating Capacity	kW	5.53(2.33)	8.61(3.61)	10.92(4.32)	5.53(2.33)	8.61(3.61)	10.92(4.32)			
Power supply		1 phase 50Hz 230V(220V-240V) / 1 phase 60Hz 220V(Separate power supply for indoor units is required.)					1 phase 50Hz 230V(220V-240V)			
Temperature exchange efficiency	Extra High	%	70.5	70.0	65.5	70.5	70	65.5		
	High	%	70.5	70.0	65.5	70.5	70	65.5		
	Low	%	71.5 / 72.0	72.5 / 73.0	67.5 / 68.0	71.5	72.5	67.5		
Enthalpy exchange efficiency	Cooling	Extra High	%	56.5	56.0	52.0	56.5	56.0	52.0	
		High	%	56.5	56.0	52.0	56.5	56.0	52.0	
		Low	%	57.5 / 58.0	59.0 / 59.5	54.0 / 55.0	57.5	59.0	54.5	
	Heating	Extra High	%	68.5	70.0	66.0	68.5	70.0	66.0	
		High	%	68.5	70.0	66.0	68.5	70.0	66.0	
		Low	%	69.0 / 69.0	73.0 / 73.5	68.5 / 69.0	69.0	73.0	68.5	
Power input (Heat exchange mode)	Extra High	kw	0.300 / 0.365	0.505 / 0.595	0.550 / 0.720	0.305	0.530	0.575		
	High	kw	0.280 / 0.350	0.465 / 0.555	0.545 / 0.665	0.285	0.485	0.565		
	Low	kw	0.235 / 0.250	0.335 / 0.390	0.485 / 0.530	0.240	0.350	0.520		
Running current	Extra High	A	1.30 / 1.65	2.25 / 2.77	2.46 / 3.38	1.33	2.37	2.56		
	High	A	1.21 / 1.62	2.07 / 2.59	2.43 / 3.11	1.24	2.14	2.51		
	Low	A	1.01 / 1.14	1.46 / 1.79	2.16 / 2.45	1.03	1.54	2.31		
Fan unit	Standard air flow	Extra High	m <sup>3</sup> /h	500	800	950	500	800	950	
		High	m <sup>3</sup> /h	500	800	950	500	800	950	
		Low	m <sup>3</sup> /h	440 / 410	640 / 600	820 / 800	440	640	820	
	External static pressure	Extra High	Pa	120 / 200	120 / 190	135 / 195	95	105	110	
		High	Pa	105 / 170	100 / 155	120 / 160	85	85	90	
		Low	Pa	115 / 150	100 / 130	105 / 130	95	90	115	
Air flow limit	Lower limit	m <sup>3</sup> /h	330	480	640	330	480	640		
	Upper limit	m <sup>3</sup> /h	600	960	1140	600	960	1140		
Humidifier	System		-	-	-	Permeable film humidifier				
	Amount		-	-	-	3.0	5.0	6.0		
	Feed water pressure		-	-	-	0.02-0.49				
Sound pressure	Extra High	dB	37.5 / 40	41 / 43	43 / 43.5	36.5	40	42		
	High	dB	36.5 / 38	40 / 42	42 / 42	35.5	39	41		
	Low	dB	34.5 / 36.5	38 / 37	40 / 40	33.5	38	39		
Sound power	dB	55	58	59	55	58	59			
Appearance			Zinc hot dipping steel plate			Zinc hot dipping steel plate				
Dimensions	HxWxD	mm	430x1140x1690	430x1189x1739	430x1189x1789	430x1140x1690	430x1189x1739	430x1189x1739		
Weight		kg	84	100	101	91	111	112		
Heat exchanger			Finned tube			Finned tube				
Heat-insulating material			Flexible urethane foam			Flexible urethane foam				
Air filter			Standard filter & High efficiency filter			Standard filter (Gravitational method 82%) & High efficiency filter (Colormetric method 65%)				
Controller			Remote controller (Separately sold parts)			Remote controller (Separately sold parts)				
Connecting piping	Gas side	mm	3/8"	1/2"	1/2"	3/8"	1/2"	1/2"		
	Liquid side	mm	1/4"	1/4"	1/4"	1/4"	1/4"	1/4"		
	Drain port (Nominal dia.)	mm	25 (Polyvinyl chloride tube)			25 (Polyvinyl chloride tube)				
Water supply connection (Port size)			-	-	-	R1/2				
Operating range	Around unit		-10 - 40°C . RH ≤80%			-10 - 40°C . RH ≤80%				
	Outdoor Air (OA)		-15 - 43°C . RH ≤80%			-15 - 43°C . RH ≤80%				
	Return Air (RA)		5 - 40°C . RH ≤80%			5 - 40°C . RH ≤80%				

Cooling and heating capacities are based on the following conditions:  
 cooling capacities are based on: indoor temperature: 27°CDB/19°C WB, Outdoor temperature: 35°C DB  
 Heating capacities are based on: indoor temperature: 20°C DB, Outdoor temperature: 7 ° CDB/6°C WB.  
 The figures in ( ) indicate the heat reclaimed from the heat recovery ventilator.

AIR-TO-AIR HEAT EXCHANGER WITH DX COIL

Drawings

Unit: mm

MMD-VN(K)502HEX1E

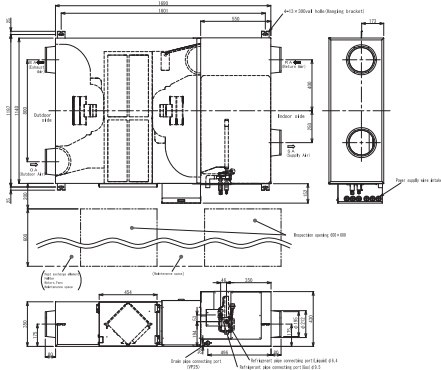

MMD-VN(K)802HEX1E

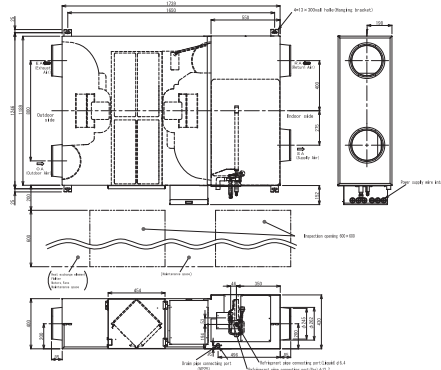

MMD-VN(K)1002HEX1E

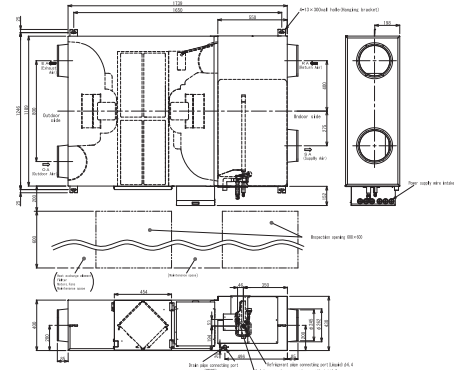

Sound pressure levels

Unit: dB(A)

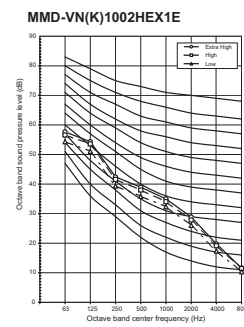
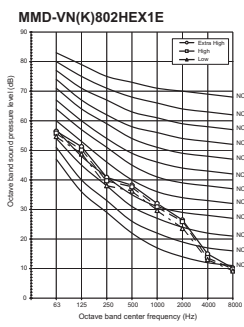
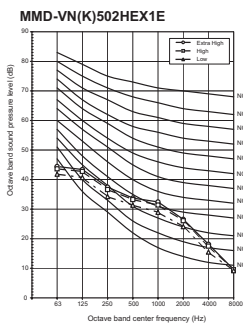

Accessories

Type	Model name	Description	Appearance	Remarks
Control	NRC-01HE	Dedicated remote controller for air-to-air heat exchanger		Integrated functions: fan speed, freecooling, air balance volume rate, temperature management and timer.
	NRB-1HE	On/off optional PCB for air-to-air heat exchanger		
Condensates	TCB-DP31HEXE	Drain pump kit		

Air-to-air heat exchanger (with DX coil) embedded connectors

CN32	CN60	CN61	CN70	CN73	CN80
Additional ventilation control from remote control	Operation status signal output (cooling, heating, fan, defrost, thermo-on)	External On/Off, operation output and alarm output	Warning symbol on remote control based on signal input. No IDU thermo off.	Forced IDU thermo-off based on signal input	Forced IDU thermo-off and IDU lock based on signal input
-	-	•	•	•	•

Other information

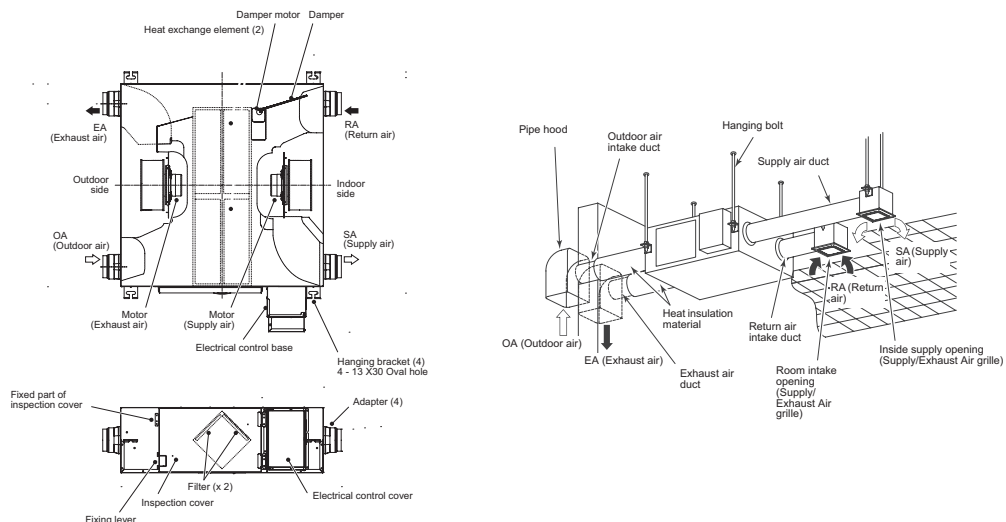

# MMD-UP\_HFP FRESH AIR INTAKE

**NEW**



This indoor unit has been specifically designed to manage and treat fresh air before its distribution into the building.

<b>CAPACITY</b>	<b>AIR FLOW</b>	<b>SOUND PRESSURE LEVEL</b>
<b>5 HP &lt; 14 HP</b>	<b>1,080m³/h &gt; 3,060m³/h</b>	<b>31dB(A)</b>

<b>OUTDOOR UNITS COMPATIBILITY</b>		<b>LOCAL CONTROLS</b>	
SMMS-u	SMMS-e up to 10HP	RBC-AXU31-E	RBC-ASCU11-E RBC-ATM31U-E RBC-AMSU51-EN/ES

## Features

Model name	MMD-	UP0481HFP-E	UP0721HFP-E	UP0961HFP-E	UP1121HFP-E	UP1281HFP-E	
Cooling capacity (*) (Note 1)	kW	14	22,4	28	33,5	40	
Heating capacity (*) (Note 2)	kW	8,9	13,9	17,4	20,8	25,2	
Electrical characteristics	Power supply	1 phase 50Hz 220-240V					
	Running current	A	0,8	0,9	1,12	1,36	1,91
	Power consumption	kW	0,11	0,16	0,2	0,25	0,33
	Starting current	A	1,95	9,4	9,4	9,4	9,4
Dimensions	Main unit HxWxD	mm	327x1430x750	477x1430x900	477x1430x901	477x1430x902	477x1430x903
Weight	Main unit	kg	44	99	99	99	99
Heat exchanger		Finned tube					
Soundproof / Heat-insulating material		Non-flammable insulation					
Fan unit	Fan	Centrifugal fan					
	Standard air flow (H/M+/M/L+/L)	m³/h	1080/990/930/840/760	1680/1560/1440/1320/1200	2100/1950/1800/1620/1470	2520/2340/2130/1950/1770	3060/2820/2580/2370/2130
	Motor	W	350		1000		
	External static pressure (factory default)	Pa	100				
	External static pressure	Pa	200-175-150-125-100-75-50				
Air flow limit	Lower limit	m³/h	600	960	1320	1500	1800
	Upper limit	m³/h	1320	2040	2520	3060	3600
Air filter		Option or field supply					
Controller		Wired remote controller					
Connecting pipe	Gas pipe	inch	15,9	22,2		28,6	
	Liquid pipe	inch	9,5		12,7		
	Drain pipe	mm			25		
Sound pressure level (H/M+/M/L+/L)	dB(A)	38/37/35/32/31	38/37/36/35/33	39/38/36/35/33	40/39/37/36/34	42/40/38/37/35	
Sound power level (High/Med./Low)	dB(A)	N/A	N/A	N/A	N/A	N/A	
Operation range for SMMS-u	Cooling (*) (Note 2)	°C	+5/+46 (Note 4)				
	Heating (*) (Note 3)	°C	-10/46				

\* The setting temperature is 13 - 25°C (standard FCU), 18 - 30 °C.  
\* Height difference between Fresh Air Intake Indoor units must be within 5 m.

Note 1 : Rated conditions  
Cooling : Outdoor air temperature 33°C DB/28°C WB setting temperature 18°C  
Heating : Outdoor air temperature 0°C DB/-2.9°C WB setting temperature 25°C  
Note 2 : When supply air temperature is "setting temperature + 3°C" or less, Fresh Air Intake unit operates as FAN mode  
Note 3 : When supply air temperature is "setting temperature -3°C" or over, Fresh Air Intake unit operates as FAN mode  
Note 4 : 46-52°C is also available but temporary operable

## Use conditions

- In COOL mode, if temperature of the fresh air is below the setup temp. of +3°C, FAN status is automatically made. When temperature of the fresh air is below 19°C, FAN status is also made regardless of the setup temperature.
- In HEAT mode, if temperature of the fresh air is above the setup temp. -3°, FAN status is automatically made. When temperature of the fresh air is above 15°C, FAN status is also made regardless of the setup temperature.

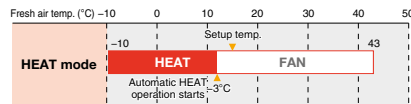
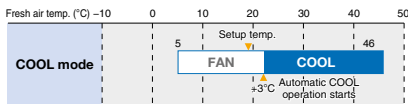

Operable mode and discharge temperature setup range

Operation mode	At shipment from factory	Setup range
COOL	18°C	13 to 25°C
HEAT	25°C	18 to 30°C

## Drawings

Unit: mm

MMD-UP0481HFP-E

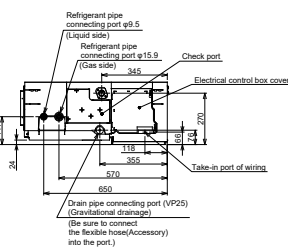
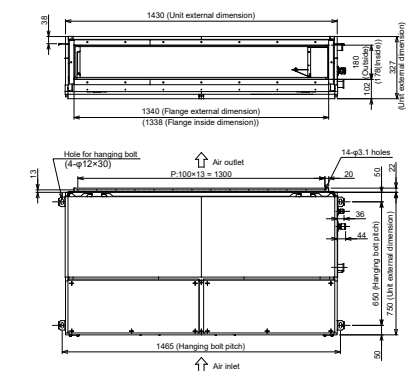

MMD-UP0721HFP-E to MMD-UP1281HFP-E

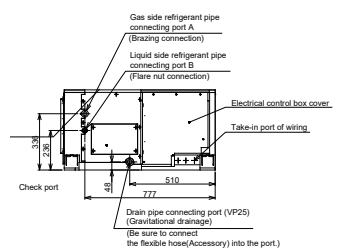
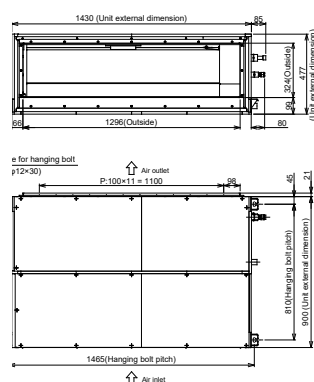

## FRESH AIR INTAKE

### Fresh air intake indoor unit type

System restriction	SMMS-e	SMMS-u	
		Multi FCU connection	All fresh air intake connection
Max. no. of combined outdoor units	1	5	2
Max. capacity of combined outdoor units	22HP	120HP	44HP
Maximum number of connected indoor units		128	-
Total capacity of combined Indoor+fresh air unit		80 to 110%	
Max. no. of combined indoor units	3 units	4 units	
Max. capacity of fresh air unit when combined with conventional indoor units		30% or less	

				Allowable value (m)		
				SMMS-e	SMMS-u	
Pipe length	Total extension of pipe (Liquid pipe)	Actual length	m	300	500/1200	300
	Farthest piping length	Equivalent length	m	150	250	230
		Actual length	m	130	210	210
	Main piping length	Equivalent length	m	120	120	120
		Actual length	m	100	100	100
	Farthest equivalent piping length from the first branching section	Equivalent length	m	30	90	90
		Actual length	m	30	30	30
Maximum equivalent length between branching sections		Equivalent length	m	30	50	50
Height difference	Height between outdoor and indoor units	Upper outdoor units	m	40	70	70
		Lower outdoor units	m	3	40	40
	Height between indoor units /fresh air intake units	m	0,5	40/5	-/5	

Please check technical literature

### Sound pressure levels

Unit: dB(A)

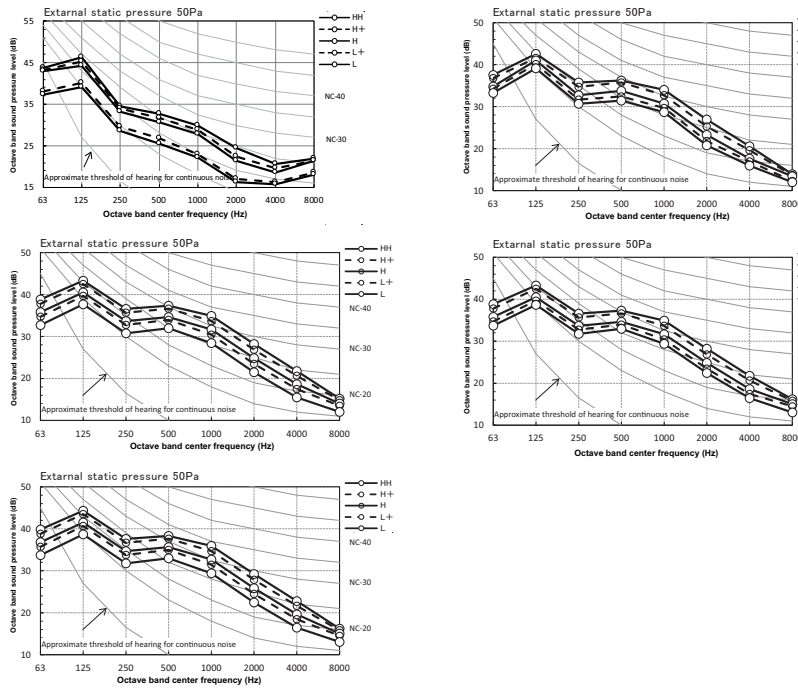

### Other information

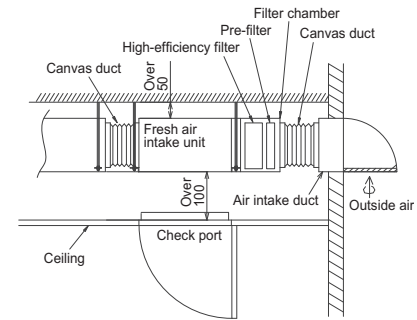

### Accessories

Type	Model name	Description	Applied model	Appearance	Remarks
Air filtration	TCB-UFM0481D-E	High-efficiency filter 65	MMD-UP0481HF-E		
	TCB-UFM1281D-E	High-efficiency filter 65	MMD-UP0721HF-E to MMD-UP1281HF-E		
	TCB-UFH0481D-E	High-efficiency filter 90	MMD-UP0481HF-E		
	TCB-UFH1281D-E	High-efficiency filter 90	MMD-UP0721HF-E to MMD-UP1281HF-E		
	TCK-LK1401D-E	Stand alone long life prefilter	MMD-UP0481HF-E		
	TCK-LK2801DP-E	Stand alone long life prefilter	MMD-UP0721HF-E to MMD-UP1281HF-E		
	TCK-LK1401D-E (*2)	High efficiency long life prefilter	MMD-UP0481HF-E		
	TCK-PF1281DF-E	High efficiency long life prefilter	MMD-UP0721HF-E to MMD-UP1281HF-E		
	TCB-FC0481DF-E	Filter chamber	MMD-UP0481HF-E		
TCB-FC1281DF-E	Filter chamber	MMD-UP0721HF-E to MMD-UP1281HF-E			
Drain pump kit	TCB-DP40DF-E	Drain pump kit	All models		

### Fresh air duct embedded connectors

	CN32	CN60	CN61	CN70	CN73	CN80
Additional ventilation control from remote control		Operation status signal output (cooling, heating, fan, defrost, thermo-on)	External On/Off, operation output and alarm output	Warning symbol on remote control based on signal input. No IDU thermo off	Forced IDU thermo-off based on signal input	Forced IDU thermo-off and IDU lock based on signal input
5HP	•	•	•	•	•	•
8-14HP	•	TCB-PCUC2E pcb needed	•	TCB-PCUC2E pcb needed	TCB-PCUC2E pcb needed	TCB-PCUC2E pcb needed

# MM-DXC STANDARD DX KIT



Built an efficient and reliable ventilation system managed by Toshiba remote controller mixing third party AHU, DX coil and Toshiba VRF system.

CAPACITY



2 HP < 60 HP

AIR FLOW



Up to 30,000m<sup>3</sup>/h

### OUTDOOR UNITS



Side Blow & Mini SMMS-e



SMMS-e



SHRM-e

### LOCAL CONTROLS



RBC-AMTU31-E

## Features

DX controller unit	MM-	DXC010	DXC012
		VRF DX COIL CONTROLLER (Individual / Header)	VRF DX COIL CONTROLLER (Follower)
Dimensions (HxWxD)	mm	400 x 300 x 150	400 x 300 x 150
Weight	kg	8	7.6
Standard rating	IP	65	65
Operating temperature/Humidity	°C / RH	5-40 / 10-90	5-40 / 10-90
Operating range - Cooling coil «Air on» temp	°C	15°CWB±24°CWB	15°CWB±24°CWB
Operating range - Heating coil «Air on» temp	°C	15°CDB±28°CDB	15°CDB±28°CDB
Power supply	V-ph-Hz	220/240-1-50	220/240-1-50

DX valve kit	MM-	DXV080	DXV140	DXV280
Nominal capacity		5.6kW, 7.1kW, 8.0kW 1.7 - 3.2 HP	11.2kW, 14.0kW, 16.0kW 4 - 6HP	22.4kW, 28.0kW 8 - 10 HP
Dimensions	mm	155 x 155 x 185		
Weight	kg	0.9kg		
Integrated components		TA, TC1, TC & TCJ sensors, PMV, sensor holder 4 & 6 mm, fix plate, strainer and P clamp (For TA)		

## Drawings

Unit: mm

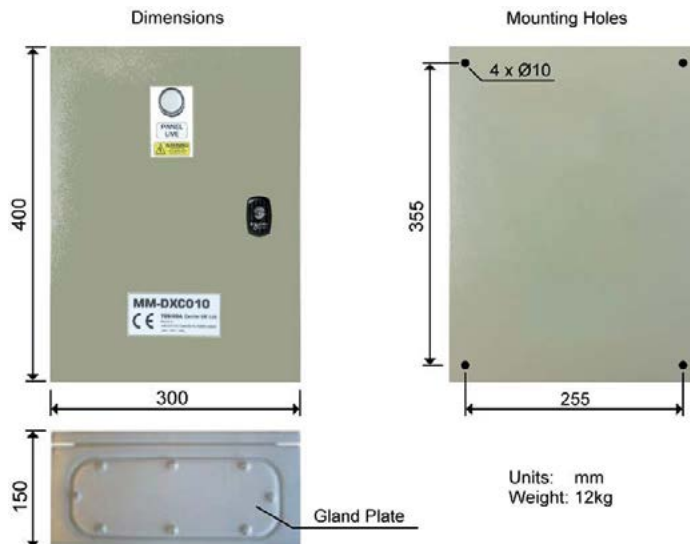



**STANDARD DX KIT**

**Capacity table**

	Capacity in HP	VRF DX Coil controller (Individual/Header)	VRF DX Coil Controller (Follower)	VRF DX Coil valve kit			Nominal capacity (kW)		DX coil internal volume (cc)			Recommended liquid capillary	Air volume flow rate (m <sup>3</sup> /h)
		MM-DXC010	MM-DXC012	MM-DXV080	MM-DXV140	MM-DXV280	Cool	Heat	Min	Std	Max	mm	Std
All models	2	1		1			5.6	6.3	850	1000	1150	3.2 ~ 3.5	900
	2.5	1					7.1	8	1063	1250	1438	3.5 ~ 4	1320
	3	1		1			8	9	1275	1500	1725	3.5 ~ 4	1320
	3.2	1		1			9	10	1360	1600	1840	3.5 ~ 4	1320
	4	1			1		11.2	12.5	1700	2000	2300	4.5 ~ 5	1600
	5	1			1		14	16	2125	2500	2875	5 ~ 5.5	2100
	6	1			1		16	17	2550	3000	3450	5.5 ~ 6	2800
	8	1				1	24	25	3400	4000	4600	6.5 ~ 7	3600
	10	1				1	28	31.5	4250	5000	5250	7 ~ 8	4200
	12	1	1			2	33.5	37.5	5100	6000	6900		5600
14	1	1		1	1	40	45	5950	7000	8050		6400	
16	1	1	1		2	45	50	6800	800	9200		7200	
18	1	1	1		2	50.4	56	7650	9000	10350		7800	
20	1	1	1		2	56	63	8500	10000	11500		8400	
22	1	1	2		2	61.5	64	9350	11000	12650		10000	
24	1	1	2		3	67	75	10200	12000	13800		10800	
26	1	1	2		3	73.5	82.5	11050	13000	14950		11400	
28	1	1	2		3	78.5	87.5	11900	14000	16100		12000	
30	1	1	2		2	85	95	12750	15000	17250		12600	
32	1	1	3		4	90	100	13600	16000	18400		14400	
34	1	1	3		4	95.4	106.5	14450	17000	19550		15000	
36	1	1	3		4	101	113	15300	18000	20700		15600	
38	1	1	3		4	106.5	114	16150	19000	21850		16200	
40	1	1	3		4	112	126	17000	20000	23000		16800	
42	1	1	4		5	117.5	127	17850	21000	24150		18600	
44	1	1	4		5	123	128	18700	22000	25300		19200	
46	1	1	4		5	130	145	19550	23000	26450		19800	
48	1	1	4		5	135	150	20400	24000	27600		20400	
50	1	1	4		5	140.4	156	21250	25000	28750		21000	
52	1	1	4		6	146	163	22100	26000	29900		22800	
54	1	1	5		6	151.5	164	22950	27000	31050		23400	
56	1	1	5		6	157	176	23800	28000	32200		24000	
58	1	1	5		6	162.5	177	24650	29000	33350		24600	
60	1	1	5		6	168	178	25500	30000	34500		25200	
12	1	1			2	33.5	37.5	5100	6000	6900		5600	
14	1	1		1	1	40	45	5950	7000	8050		6400	
16	1	1			2	45	50	6800	800	9200		7200	
18	1	1			2	50.4	56	7650	9000	10350		7800	
20	1	1			2	56	58	8500	10000	11500		8400	
22	1	1	2		2	61.5	69	9350	11000	12650		10000	
24	1	1	2		3	68	76.5	10200	12000	13800		10800	
26	1	1	2		3	73.5	82.5	11050	13000	14950		11400	
28	1	1	2		3	80	90	11900	14000	16100		12000	
30	1	1	2		2	85	95	12750	15000	17250		12600	
32	1	1	3		4	90.4	101.4	13600	16000	18400		14400	
34	1	1	3		4	95.4	106.5	14450	17000	19550		15000	
36	1	1	3		4	100.8	113	15300	18000	20700		15600	
38	1	1	3		4	106.5	114.5	16150	19000	21850		16200	
40	1	1	3		4	112	126	17000	20000	23000		16800	
42	1	1	4		5	120	135	17850	21000	24150		18600	

DX-Coils > 10HP must be designed with multiple sections each 10HP or less. These sections must have dedicated Headers and liquid capillary distributors. Therefore recommended office sizes only 2 - 10 HP



Cooling Capacity Conditions (Indoor 27 °Cdb / 19 °Cwb & Outdoor 35 °Cdb) at Standard Air Flow rate  
 Heating Capacity Conditions (Indoor 20 °Cdb & Outdoor 7 °Cdb / 6 °Cwb) at Standard Air Flow rate  
 DX-Coils > 10HP must be designed with multiple pathways each 10HP or less. These pathways must have dedicated Headers and Liquid Capillary distributors. Therefore recommended sizes only needed for 2 - 10HP.

SHRMe Capacity quoted as nominal cooling and maximum heating.  
 The standard Air volume flow rate is a guideline. The required capacity should determine DX-Interface size selection.  
 Single Port Flow Selectors (3-Series) MUST be used with the DX-Interface. It is not compatible with Multi Port Flow Selector (This limits the maximum SHRMe DX-Interface size to 42HP).

**Other information**

- The DX Coil **MUST** be operated within the following limits to ensure reliability:
  - Cooling mode DX coil "air on" temp: Min: 15°C WB (18°CDB) ~ Max: 24°C WB (32°CDB)
  - Heating mode DX coil "air on" temp: Min: 15°C DB ~ Max: 28°C DB
- When used for ventilation, the DX-Coil **MUST** be combined with other equipment such as heat recovery exchanger or heaters / coolers to ensure that the CA limits are not exceeded:

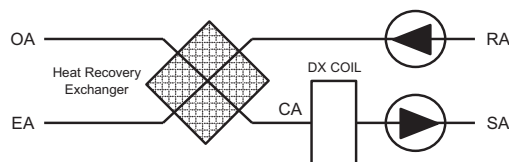

OA	Outdoor Air
SA	Supply Air
CA	Coil Air (After Heat Recovery Exchanger)
RA	Return Air
EA	Exhaust Air

**DX-Coil design**

- The DX Coil must be suitable for R410A.
- The design should allow operation as both an evaporator and a condenser (Features: Multiple circuits / Liquid Capillary Distributor / Gas Header).
- The counter flow principle must be observed.
- Design target evaporation temperature: 6.5°C.
- Design target condensation temperature: 52°C.
- A drain pan must be fitted (even if only used in heat mode) due to defrost cycles.
- It is recommended to fit droplet eliminator plates in the discharge air stream if used in cool mode.
- The sensor holders must be brazed on to DX-Coil to ensure accurate temperature sensing.
- DX Coils (>10HP) must be designed with multiple pathways each 10HP or less. These pathways must have dedicated headers and liquid capillary distributors each with the appropriate DX valve kit. These DX-Coils can be Interlaced or split face:-
- Where grouped the header controller (MM-DXC010) must be connected to the largest DX-Coil valve kit.
- AHU fan motor must be interlocked to fan control output.
- Maximum DXCoil U-pipe outer diameter: 12.7 mm (1/2")
- Recommended DX-Coil U-pipe outer diameter: 9.52 mm (3/8")

# RBC-DXC 0/10V DX KIT



Control the capacity of the Toshiba VRF system directly from the air handling unit controller to maintain constant fresh air temperature intake inside the building: the ultimate in fresh air solution.

CAPACITY



6 HP &lt; 10 HP

AIR FLOW

Up to 6000m<sup>3</sup>/hOUTDOOR UNITS  
COMPATIBILITY

SMMS-e

LOCAL CONTROLS



RBC-AMTU31-E

## Features

LC / VRF DX Coil Controller Unit	RBC-	DXC031
Minimum air flow rate	m <sup>3</sup> /h	2310
Maximum air flow rate	m <sup>3</sup> /h	3960
Dimensions (HxWxD)	mm	400 x 300 x 165
Weight	kg	8
Cable max length (Analogue Input) (Screened cable: 0.5 ~ 1.0 mm <sup>2</sup> )	m	200
Cable max length (Digital Input) (Non screened cable: 1.5 ~ 2.5 mm <sup>2</sup> )	m	100
Cable max length (Digital Output) (Non screened cable: 1.5 ~ 2.5 mm <sup>2</sup> )	m	500
Cable max length (TCC Link) (Screened cable: 1.5 ~ 2.5 mm <sup>2</sup> )	m	1000
Standard rating	IP	65
Operating temperature/humidity	°C / RH	5-40 / 10-90
Operating range - Cooling coil «Air on» temp	°C	15°CWB+24°CWB
Operating range - Heating coil «Air on» temp	°C	12°CDB+28°CDB
System diversity	%	75 - 100
Outdoor Unit		8 & 10HP SMMS-e only
Power supply		220 - 240V AC 50Hz

VRF DX coil controller unit	RBC-	DXC031	DXC031	DXC031
VRF DX PMV valve unit	MM-	DXV141	DXV281	DXV281
Cooling capacity	kW	16.0	22.4	28.0
Heating capacity	kW	18.0	25.0	31.5
Capacity code	HP	6.0	8.0	10.0

Heating & Cooling Capacity are guide-line figures, the design of each customer's AHU and DX Coil will have an impact on the actual system performance  
Cooling Capacity Conditions (Indoor 27 °Cdb / 19 °Cwb & Outdoor 35 °Cdb) at Standard Air Flow rate  
Heating Capacity Conditions (Indoor 20 °Cdb & Outdoor 7 °Cdb / 6 °Cwb) at Standard Air Flow rate

## Drawings

Unit: mm

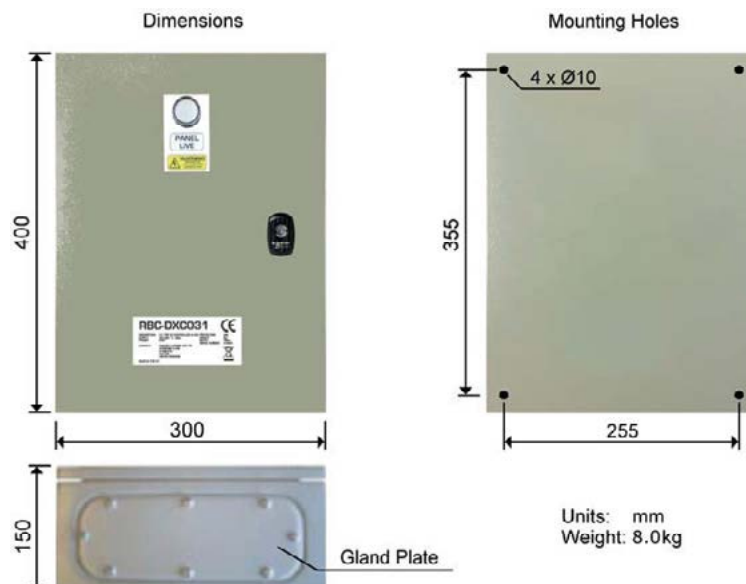

**Capacity table**

	Capacity in HP	Diversity ratio	VRF DX Coil controller (Individual/Header)		VRF DX Coil valve kit		Nominal capacity (kW)				DX coil internal volume (cc)		Recommended liquid capillary	Air volume flow rate (m <sup>3</sup> /h)
			RBC-DXC031	MM-DXV141	MM-DXV281	Cool		Heat		Min	Max	mm	Std	
			Min	Max	Min	Max	Min	Max	Min	Max				
<b>SMMSe</b>	6	75 to 100%	1	1		8	16	7.2	18	1700	3200	5.5 ~ 6	3300	
	8		1	1	11.2	22.4	10	25	3000	4200	6.5 ~ 7	4300		
	10		1	1	14	28	12.6	31.5	3000	5400	7 ~ 8	5000		

Cooling & Heating output figures are based on calculations and 'general' test data. All figures are to be taken as approximations. The properties of the 3rd Party DX Coil will have an effect on the performance of the Outdoor units. The DX Coil must be suitable for R410A. The design should allow operation as both an Evaporator and a Condenser (Features: Multiple circuits / Liquid Capillary Distributor / Gas Header). The standard Air volume flow rate is a guideline. The required capacity should determine DX-Interface size selection.

The counter flow principle must be observed for the DX coil design. A Drain Pan must be fitted (even if only used in Heat mode) due to defrost cycles. It is recommended to fit droplet eliminator plates in the discharge air stream if used in Cool mode. 1:1 Connection: The DX Interface (0-10V) must be connected 1:1 with Toshiba outdoor units. Only Heating and Cooling Modes are available on the RBC-DXC031 (No Automatic or Fan Only).

IDU

**Inputs and Outputs**

	Terminal block	Description	Type	Remarks
<b>Input</b>	TB4 & 5	Capacity demand	Analog input	0/10V
	TB6 & 7	On /Off	Digital input	
	TB8 & 9	Mode input	Digital input	
	TB14 & 15	Safety contact input	Digital input	NC
	TB16 & KP1	Fan error input	Digital input	KP1.14_NO
<b>Output</b>	KP2	Fan Operation	Digital output	KP2.11 & KP2.12_NC / KP2.14_NO 250VAC 6A
	KP3	Alarm output	Digital output	KP3.11 & KP3.12_NC / KP3.14_NO 250VAC 6A
	KP4	Defrost output	Digital output	KP4.11 & KP4.12_NC / KP4.14_NO 250VAC 6A
	KP5	VRF Start-up Control	Digital output	KP5.11 & KP5.12_NC / KP5.14_NO 250VAC 6A
	KP6	VRF Pre-Defrost Active	Digital output	KP6.11 & KP6.12_NC / KP6.14_NO 250VAC 6A
	KP7	Heat Mode Active / Cool Mode Active	Digital output	KP7.11 & KP7.12_NC / KP7.14_NO 250VAC 6A
	TB10 & 11 (SW1_0)	Capacity lower than Capacity Demand	Digital output	
	TB12 & 13 (SW2_0)			
	TB10 & 11 (SW1_1)	Capacity higher than Capacity Demand	Digital output	
	TB12 & 13 (SW2_1)			
	TB10 & 11 (SW1_2)	VRF Cooling Oil Recovery / VRF Heating refrigerant recovery control	Digital output	
	TB12 & 13 (SW2_2)			
	TB10 & 11 (SW1_3)	Cooling Mode Active	Digital output	
TB12 & 13 (SW2_3)				
TB10 & 11 (SW1_4)	Heating Mode Active	Digital output		
TB12 & 13 (SW2_4)				

**Other information**

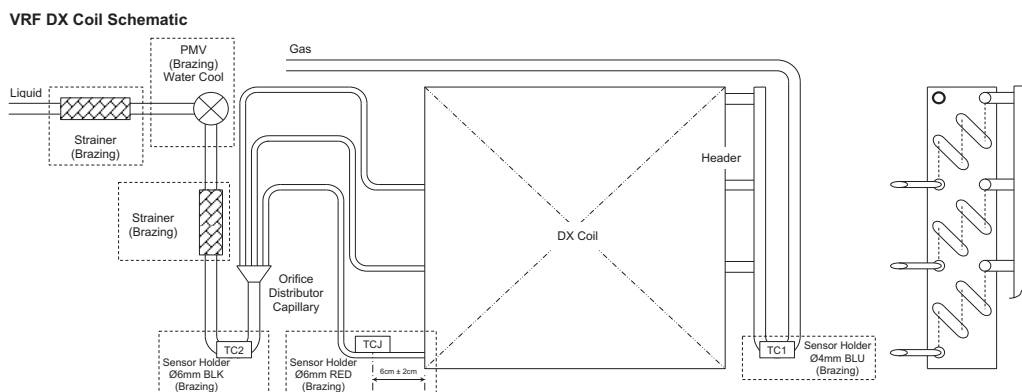

- Notes:**
- 1) The PMV must be water cooled whilst brazing, to prevent damage to the mechanism.
  - 2) To ensure reliable operation, all Sensor Holders must be fitted by brazing.
  - 3) The TCJ Sensor Holder must be brazed to the capillary on the DX Coil's lowest circuit.
  - 4) For brazing, be sure to use nitrogen gas to avoid oxidation of pipe inner surface.



With the mid temperature hot water module, produce hot water in addition of cooling and heating.

CAPACITY



8kW > 16kW

HOT WATER



Max 50°C

SOUND PRESSURE LEVEL



25dB(A)

OUTDOOR UNITS COMPATIBILITY



MINI SMMS-e  
8 & 10HP

SMMS-u

SMMS-e

SHRM-e

LOCAL CONTROLS



RBC-ASCU11-E  
RBC-AMTU31-E  
RBC-AMSU51-EN/ES

Features

Model	MMW-	UP0271LQ-E	UP0561LQ-E	
<b>Heating capacity *1</b>	<b>kW</b>	<b>8,0</b>	<b>16,0</b>	
<b>Electrical characteristics</b>	Power supply *2	1 phase 50 Hz 230 V (220 - 240 V)		
	Running current	A	0,08	
	Power consumption	W	14	
<b>Appearance</b>		Zinc hot dipping steel plate		
<b>Dimensions</b>	Unit HxL(leg included)xD	mm 580x400(467)x250		
<b>Weight</b>	Unit	kg	17,8	
<b>Design pressure</b>	Refrigerant side	MPa	3,73	
	Water side	MPa	1,0	
<b>Heat exchanger</b>		Plate type heat exchanger		
<b>Heat-insulating material</b>		Polyethylene foam + Polyurethane foam		
<b>Water flow rate</b>	Standard	L/min	22,9	
	Min.	L/min	19,5	
<b>Water pressure loss (at standard water flow rate)</b>		kPa	40,5	
<b>Controller</b>			Remote controller	
<b>Operation range</b>	Indoor	CDB	5 - 32	
		CWB	23 or less	
		RH(%)	30 - 85	
		Outdoor (at heating)	CDB	-20 - 21
	Ambient	MINI SMMS-e	CWB	-20 - 15
		Outdoor (at heating)	CDB	-25 - 21
			SMMS-e, SMMS-u	CWB
		Outdoor (at heating)	CDB	-25 - 40
SHRM-e	CWB		-25 - 28	
<b>Water filter</b>	Water inlet side	C	15 or more and 45 or less	
	Water outlet side	C	25 - 50	
<b>Connecting pipe</b>	Water pipe	Inlet	Strainer with Mesh 30 to 40 (procured locally)	
		Outlet	R1 - 1/4	
	Refrigerant pipe	Gas pipe	inch	15.9 flare connection
		Liquid pipe	inch	9.5 flare connection
	Drain pipe		R1	
<b>Sound pressure level</b>		dB(A)	25	
<b>Sound power level</b>		dB(A)	25	
<b>Installation place</b>			Indoor	

\*1: Rated conditions: Inlet water temp. 30 °C outlet water temp. 35 °C Outdoor air temp. 7 °CDB / 6 °CWB  
 The standard piping means that mean pipe length is 5 m, branching pipe length is 2.5 m of branch piping connected with a 0 meter height.  
 \*2: The source voltage must not fluctuate more than ±10%.  
 \*3: The unit is packed in a sideways state.

Drawings

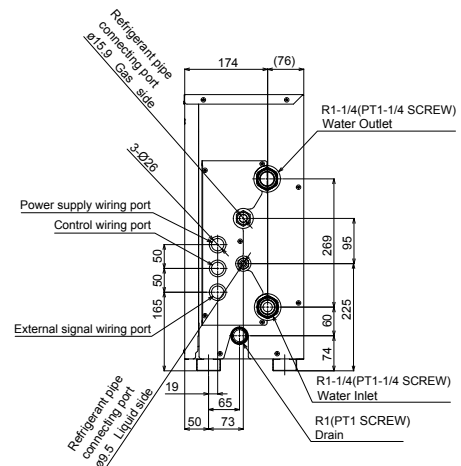
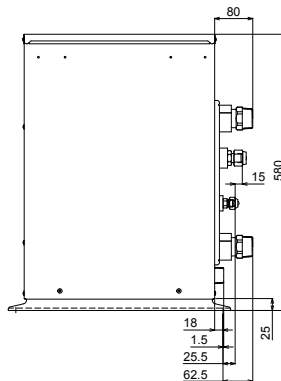
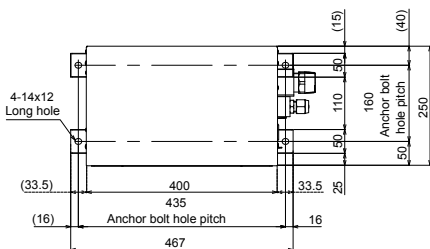

Unit: mm

## MID TEMPERATURE HOT WATER MODULE

### Allowable length / height difference of refrigerant piping

		Mini SMMSe 8/10HP (without PMV kit)	SMMSu	SMMSe	SHRMe	
Piping length	Total extension of pipe (Liquide pipe, real length)	Below 34HP 34HP or more	300m	500m	300m	300m
	Farthest piping length	Equivalent length	150m	250m	235m	200m
		Real length	120m	210m	190m	180m
	Equivalent length of farthest piping form 1st branching	High diffeence between IDU >3m	40m	65m	65m	50m
		High diffeence between IDU ≤3m	40m	90m	90m	65m
	Equivalent length of farthest piping between outdoor units			40m	25m	15m
	Max equivalent length of main piping	High diffeence between IDU >3m	80m	120/100m	120/100m	100/85m
		High diffeence between IDU ≤3m				120/100m
	Max. equivalent length of outdoor unit connecting piping			10m	10m	10m
	Max. real length of indoor unit connecting piping		15m	30m	30m	30m
Max. equivalent length between branches			50m	50m	50m	
Maximum real length of terminal branching section to indoor units	Single port type				15m	
	Multi port type				50m	
Maximum equivalent length between branching section					50m	
Difference in height	Height between indoor and outdoor units	Upper outdoor unit	10m	70m	70m	70m
		Lower outdoor unit	10m	40m	40m	30m
	Height between indoor units	Upper outdoor unit	15m	3m*	3m*	40m
		Lower outdoor unit		10m*	10m*	15m
	Height between HWM	Upper outdoor unit	10m	3m	3m	40m
		Lower outdoor unit	10m			15m
	Height between indoor units and HWM	Upper outdoor unit	10m	3m*	3m*	40m
		Lower outdoor unit	10m	10m*	10m*	15m
Height between outdoor units			5m	5m	5m	
In case of 4serie flow selector connection to indoor units	Maximum equivalent length indoor units in group control by one single port flow selector unit				30m	
	Maximum real length between flow selector unit and indoor unit	Single port type			15m	
		Multi port type			50m	
Height difference between indoor units in group control by one flow selector unit					0.5m	

\* 40m if hot water module and indoor units are not operating at the same time.

↑ IDU

### Diversity and connectivity restrictions

		Mini SMMSe 8/10HP (without PMV kit)	SMMSu	SMMSe	SHRMe	
Indoor connection capacity	Total	Standard indoor unit + M-HWM	80 - 200%	65 - 115%	65 - 115%	90 - 135%
	Allowed capacity	Standard indoor unit M-HWM	80 - 130% 0 - 100%	50 - 115% 0 - 50%	50 - 115% 0 - 50%	50 - 120% 0 - 67.5%
Number of combined indoor units and M-HWM	Total	Standard indoor unit + M-HWM	8HP 2 - 12 10HP 2 - 16	2 - 128	2 - 64	2 - 32
	Allowed number	Standard indoor unit			2 - 128	2 - 64
		M-HWM		0 - 4	0 - 2	0 - 2

### Sound pressure levels

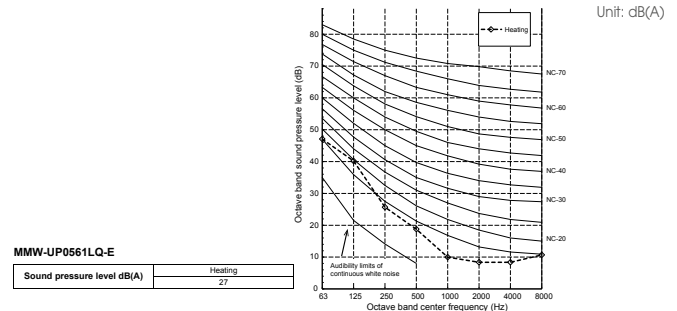
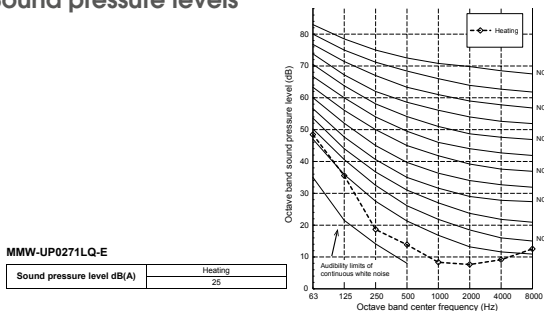

Unit: dB(A)

### Other information

#### Water piping and line heater installation

- Make the piping route a closed circuit. (An open water circuit may cause a failure.)
- Before a long period of none use, purge the water out of the pipes and thoroughly let them dry.
- Do not add brine to the circulating water.
- Do not use the water used for the unit for drinking or food manufacturing.
- To ensure easy maintenance, inspection, and replacement of the unit, use a proper joint, valve, etc. (procured locally) on the water inlet and outlet port.
- Be sure to install a strainer with 30 to 40 meshes (procured locally) on the water inlet pipe. If a strainer is not installed, this may cause impaired performance, or damage to the plate heat exchanger from freezing.
- Install a suitable air vent (procured locally) on the water pipe. After sending water through the pipe, be sure to vent the excess air.
- To avoid water leak, wrap some sealing tape around the screw part.
- Water pipes can get very hot, depending on the preset temperature. Wrap the water pipes with heat insulation (procured locally) to prevent burns.
- Be sure to install the line heater (procured locally) on the water inlet side. In addition, position it within 5 m of the water inlet pipe of the Hot Water Module.
- Follow capacity table to select a line heater (procured locally) within the range of 40 to 50% of the Hot Water Module's rated capacity.

Hot Water Module model name	Capacity of line heater (kW)
MMW-UP0271LQ-E	3.2~4.0
MMW-UP0561LQ-E	6.4~8.0

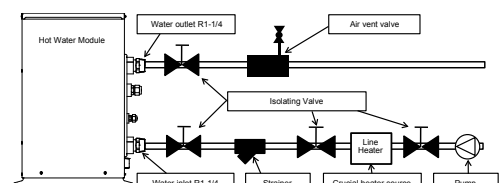



In addition to the standard simultaneous heating and cooling function of the SHRMe system, it is now possible with the new Toshiba high temperature hot water module, to produce hot water up to 85°C, whilst still retaining the comfort operation of the indoor units.

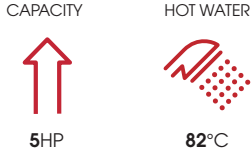

OUTDOOR UNITS COMPATIBILITY



SHRM-e

LOCAL CONTROLS



RBC-AMTU31-E

Features

Model		MMW-AP0481CHQ-E	
Heating capacity *1		kW	
		14.0	
Electrical characteristics	Power supply *2	1 phase 50 Hz 220-240 V	
	Running current (max)	A	
	Power consumption (max)	kW	
Appearance		Zinc hot dipping steel plate	
Dimensions	HxWxD(leg included)	mm	
		700x900x320(400)	
Weight	Unit	kg	
		100	
Design pressure	Refrigerant (R410A) side	MPa	
	Refrigerant (R134a) side	MPa	
	Water side	MPa	
		1.0	
Heat exchanger (Water)		Plate type heat exchanger	
Heat exchanger (Cascade)		Plate type heat exchanger	
Heat-insulating material		Polyethylene foam + Polyurethane foam	
Water flow rate	Standard	L/min	40
	Max - Min.	L/min	46 - 34
Water pressure loss (At standard water flow rate)		kPa	
		15	
Control method		Wired remote controller (Option)	
Operation range		indoor	°CDB
			+5 / +32
	Ambient covre		°CWB
	Indoor, allowable and Outdoor	Allowable dew point	RH(%)
			+30 / +85
		Outdoor (At heating)	°CDB
		SHRM-e	°CWB
			-25 / +40 (*3)
			-25 / +28 (*3)
	Water outlet side		°C
			+50 / +82
Water filter		Strainer with mesh 30 to 40 (Procured locally)	
Connecting pipe	Water pipe	Inlet	R1-1/4
		Outlet	R1-1/4
	Refrigerant pipe	Gas pipe	inch
		Liquid pipe	inch
Drain nipple		mm	
			ID 15
Sound pressure level *1		dB(A)	
		44	
Sound power level *1		dB(A)	
		60	
Refrigerant	type/charge	kg/ TCO <sub>2</sub> eq	R134A 2.1/3
Installation place		Indoor	

\*1 Rated conditions: entering condenser water temp. 60°C leaving condenser water temp. 65°C Outdoor air temp. 7°CDB / 6°CWB  
 The standard piping means that main pipe length is 5 m, branching pipe length is 2.5 m of branch piping connected with a 0 meter height.  
 \*2 The source voltage must not fluctuate more than ±10%.  
 \*3 Low ambient heating (-20°C or less) for extended periods of time is not allowed.  
 Model name of usable Flow Selector unit: RBM-Y1124FE, RBM-Y1804FE, RBM-Y2804FE, RBM-Y1801F6PE, RBM-Y1801F4PE

Drawings

Unit: mm

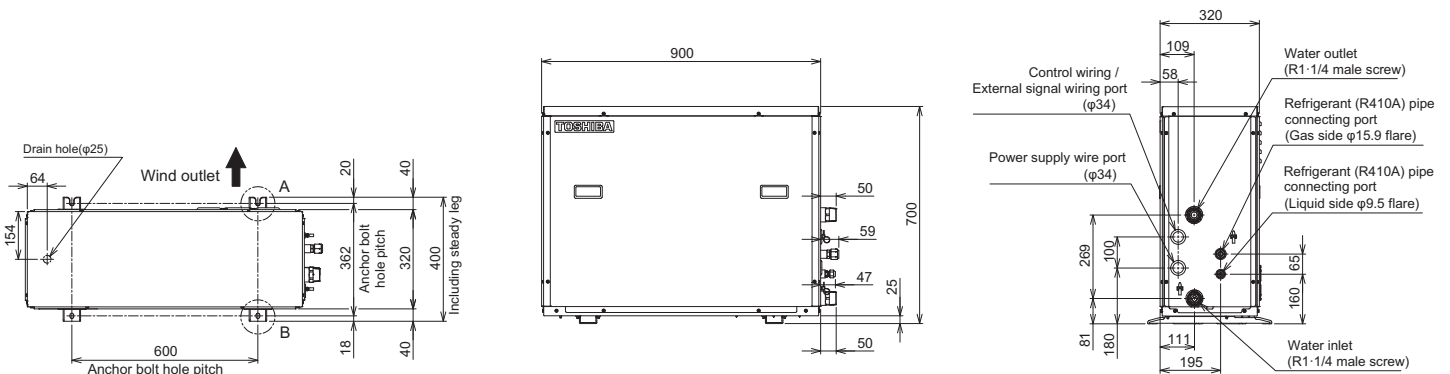

## HIGH TEMPERATURE HOT WATER MODULE

↑ IDU

### Piping rules

			SHRMe
Piping length	Total extension of pipe (Liquid pipe, real length)	Below 34HP	300m
		34HP or more	1000m
	Farthest piping length	Equivalent length	200m
		Real length	180m
	Equivalent length of farthest piping form 1st branching	High difference between IDU >3 m	50m
		High difference between IDU ≤ 3m	65m
	Equivalent length of farthest piping between outdoor units		15m
	Max equivalent length of main piping	High difference between IDU > 3m	100/85m
		High difference between IDU ≤ 3m	120/100m
	Max. equivalent length of outdoor unit connecting piping		10m
	Max. real length of indoor unit connecting piping		30m
	Max. equivalent length between branches		50m
Maximum real length of terminal branching section to indoor units	Single port type	15m	
	Multi port type	50m	
Maximum equivalent length between branching section		50m	
Difference in height	Height between indoor and outdoor units	Upper outdoor unit	70m
		Lower outdoor unit	30m
	Height between indoor units	Upper outdoor unit	40m
		Lower outdoor unit	15m
	Height between HWM	Upper outdoor unit	40m
		Lower outdoor unit	15m
	Height between indoor units and HWM	Upper outdoor unit	40m
		Lower outdoor unit	15m
Height between outdoor units		5m	
In case of 4serie flow selector connection to indoor units	Maximum equivalent length indoor units in group control by one single port flow selector unit		30m
	Maximum real length between flow selector unit and indoor unit	Single port type	15m
		Multi port type	50m
Height difference between indoor units in group control by one flow selector unit			0.5m

### Connectivity restrictions

			SHRMe
Indoor connection capacity	Total	Standard indoor unit + M-HWM + H-HWM	90 - 200%
	Allowed capacity	Standard indoor unit	50 - 120%
		H-HWM	0 - 100%
Number of combined indoor units and M-HWM	Total	Standard indoor unit + M-HWM + H-HWM	2 - 32
	Allowed number	Standard indoor unit	2 - 32
		H-HWM	0 - 12

### Sound pressure levels

Unit: dB(A)

#### MMW-AP0481CHQ-E

Sound pressure level dB(A)	Heating
	44

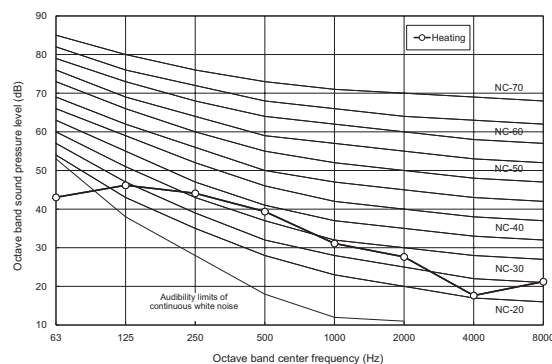

### Other information

#### Water piping and line heater installation

- Make the piping route a closed circuit. (An open water circuit may cause a failure.)
- Before a long period of none use, purge the water out of the pipes and thoroughly let them dry.
- Do not add brine to the circulating water.
- Do not use the water used for the unit for drinking or food manufacturing.
- To ensure easy maintenance, inspection, and replacement of the unit, use a proper joint, valve, etc. (procured locally) on the water inlet and outlet port.
- Be sure to install a strainer with 30 to 40 meshes (procured locally) on the water inlet pipe.
- If a strainer is not installed, this may cause impaired performance, or damage to the plate heat exchanger from freezing.
- Install a suitable air vent (procured locally) on the water pipe. After sending water through the pipe, be sure to vent the excess air.
- To avoid water leak, wrap some sealing tape around the screw part.
- Water pipes can get very hot, depending on the preset temperature. Wrap the water pipes with heat insulation (procured locally) to prevent burns.
- Be sure to install the line heater (procured locally) on the water inlet side. In addition, position it within 5 m of the water inlet pipe of the Hot Water Module.
- Follow capacity table to select a line heater (procured locally) within the range of 40 to 50% of the Hot Water Module's rated capacity.

Hot Water Module model name	Capacity of line heater (kW)
MMW-AP0481CHQ-E	5.8 ~ 7.2

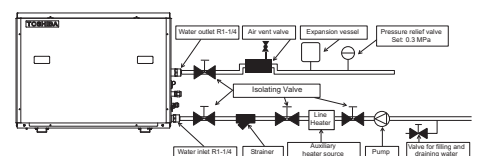

# WIRELESS SOLUTIONS KEEP CONTROL!



In addition to the high quality of the air conditioners, the controls also play a significant part in the ease-of-use and efficiency of the units. Optimized settings create the perfect climate. As well as local control options, Toshiba also offers a broad selection of central control systems or the option to integrate these in the building control system.

## > ONE CONTROL FOR EVERY USAGE



### Local controls

Cable remote controls (max. cable length 500 m) or wireless infrared remote controls are used to control individual units or groups of up to 8 indoor units. Additional modules allow units to be controlled from any location via apps or the Internet.



### Central controls

VRF systems can be controlled from a preferred central location, such as the reception or plant room. Cable lengths can be max. 2,000m and up to 512 indoor units can be controlled.



### Building control systems

Toshiba air conditioners can be interlinked with all conventional building control systems. This makes air conditioning an integral part of the central control of a building.

## > WHEREVER YOU ARE



On the cloud with Toshiba AC control app

Locally with standard remote control

Using Toshiba WebBrowser for all your facilities

## > TRUST TOSHIBA TU2C LINK

All control devices are connected to the air conditioner side using Toshiba's dedicated central control network, also called the TU2C LINK. It can be used to directly connect all equipment.

**Wiring:** 2-core, non-polarity

**Type:** Shield wire

**Size/length:**

• 1 to 1.5 mm<sup>2</sup> / Up to 1,000 m

• 2 mm<sup>2</sup> / Up to 2,000 m



## INDIVIDUAL REMOTE CONTROLLER

TYPE		INFRARED					WIRED			
Part number		RBC-AXU31-E	RBC-AXU31U-E	RBC-AXU31UM-E	RBC-AXU31C-E	RBC-AX33UYP-E	RBC-ASCU11-E	RBC-AMTU31-E	RBC-AMSU51-EN/ES	NRC-01HE
Picture										
Dimensions (h x i x p) in mm	Remote	157x56x19mm	157x56x19mm	157x56x19mm	157x56x19mm	157x56x19mm	86x86x16mm	120x120x16mm	120x120x20mm	120x120x16mm
	Infrared receiver	120x70x18mm	163x163x24mm	163x163x24mm	130x65mm	tbc				
Compatibility		All indoor units	4 way cassette	Compact 4 way cassette	Ceiling	1 way cassette (VHP)	All indoor units	All indoor units	All indoor units	Air to air heat exchanger
Connectivity		1:1	1:1	1:1	1:1	1:1	1:16	1:16	1:16	1:8
Standard functions	On/Off	•	•	•	•	•	•	•	•	•
	Mode (heat, cool, ventilation, dry, auto)	•	•	•	•	•	•	•	•	•
	Temperature setting	• / 17°C - 30°C	• / 17°C - 30°C	• / 17°C - 30°C	• / 17°C - 30°C	• / 17°C - 30°C	• / 18°C - 29°C	• / 18°C - 29°C	• / 18°C - 29°C	• / 18°C - 29°C
	Fan speed (auto, manual 5 speed)	•	•	•	•	•	•	•	•	•
Scheduling	Air direction (swing mode or manual orientation)	•	•	•	•	•	•	•	•	•
	Timer function	•	•	•	•	•	•	•	•	•
	Schedule function						•		•	
	Return back								•	
Advanced functions	Dual set point								•	
	Soft cooling								•	
	Night operation								•	
	Energy save function							•		•
	Frost protection							•		•
	Lock function								•	
	Summer time								•	
Installation & maintenance	Room naming								•	
	Filter dirty indication						•		•	
	Error display	•	•	•	•	•	•	•	•	•
	System settings						•		•	
Outputs	Indoor unit serial number								•	
	Error output						•		•	•
Display & Interface	External ventilation control							•		
	Interface	Icon	Icon	Icon	Icon	Icon	Icon	Icon	Menu	Icon
	Multilanguage								•	
	Luminous buttons								•	
Other	Backlight display						•		•	
	Temperature sensor						•	•	•	•
Communication protocol		TU2C link	TU2C link	TU2C link	TU2C link	TU2C link	TU2C link	TU2C link	TCC Link	

### Installation drawings

#### Individual control

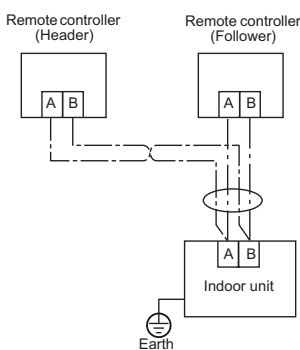

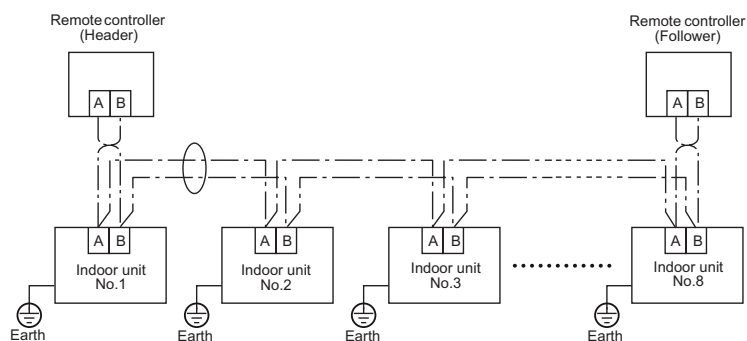

#### Group control



\* The Header or Follower remote controller can be connected to any indoor unit.

# CENTRAL CONTROL

TYPE		WIRED	WIRED
Part number		TCB-SC640U-E	BMS-SM1281ETLE Smart Manager
Picture			
Dimensions (hxtxp)		120x120x16mm	180x120x90mm
Compatibility		all systems	all systems
Connectivity		1:64	1:128
Standard function	On/Off	•	•
	Mode (heat, cool, ventilation, dry, auto)	•	•
	Temperature setting	•	•
	Fan speed (auto, manual 5 speed)	•	•
	Air direction (swing mode or manual orientation)	•	•
Scheduling	Timer function		•
	Schedule function	•	•
	Return back		•
Advanced functions	Dual set point		•
	Soft cooling		•
	Energy save function		•
	Energy monitoring		• (If power meter, BMS-IFWH5E interface relay needed)
Central control	Permit/prohibit function	•	•
	Groupe control	•	•
Installation & maintenance	Filter dirty indication	•	•
	Error display	•	•
	Error transfert by Email		•
	System setting	•	v
Display & Interface	Interface	Menu	Icon
	Multilanguage	•	•
	Luminous buttons	•	
	Backlight display	•	
Outputs	Digital Input/output		• (BMS-IFDD03E interface needed)
	Web connection		•
Communication protocol		TU2C Link	TCC Link

## Drawings

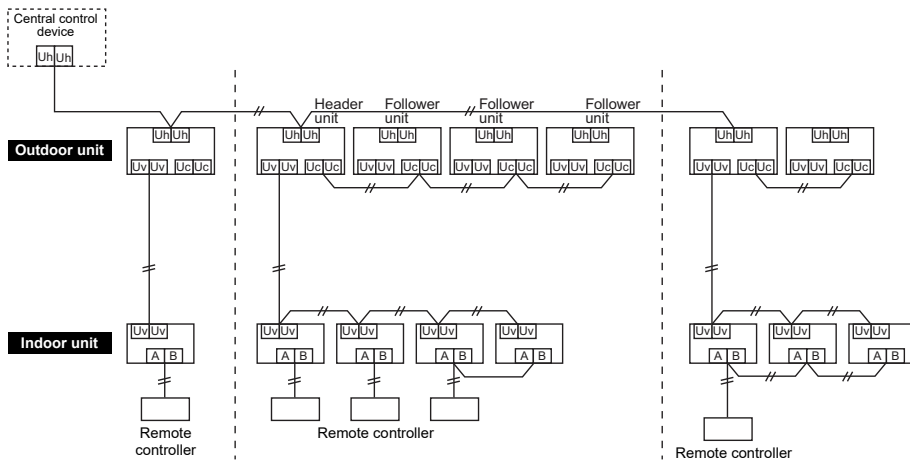

## Focus on Web Browser

The Smart Manager can be remotely connected via a computer and all functions can be controlled via web browser:

Standard operation - Advanced scheduling - Dual set point management - Up to 64 zones - Permit/Prohibit function - Energy saving - Return back

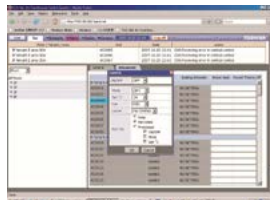

## Focus on Data Analyzer

With or without power meter, the Data Analyzer software allows facility manager to manage system energy consumption. Through graphics on different periods, different indoor units, different energy consumption zones can be compared to optimize global efficiency. Set point, ambient temperature and outdoor temperature are monitored.

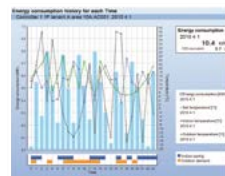

Energy consumption history

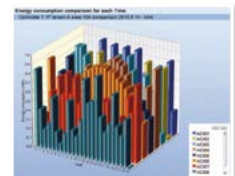

Energy consumption comparison

Part number	BMS-IWF0320E	
App name	Smart Device control interface	
App name	Toshiba AC control	
Picture		
Dimensions (h x l x p)	140x90x45mm	
Compatibility	All indoor units (except hot water module, DX kit, fresh air, A2A heat exchanger)	
Connectivity	1:32	
Standard functions	On/Off	•
	Mode (heat, cool, ventilation, dry, auto)	•
	Temperature setting	•
	Fan speed (auto, manual 5 speed)	•
	Air direction (swing mode or manual orientation)	•
Scheduling	Timer function	•
	Schedule function	•
	Return back	•
Advanced functions	Energy save function	•
	Eco temperature schiff	•
	Soft cooling	•
	Customize room/floor/building name	•
Central control	Permit/prohibit function	•
	Group control	•
Display & interface	Interface	App
	Multilanguage	•
	App compatibility	Android & IOS
	Devices compatibility	Smartphone and Phablet
Installation & miantenance	Filter dirty indication	•
	Error display	•
	Error transtert by Email	•
Users	User acces	Login & Password
	Max user	1 admin / 32 users
Communication protocol	TCC Link	

### Drawings

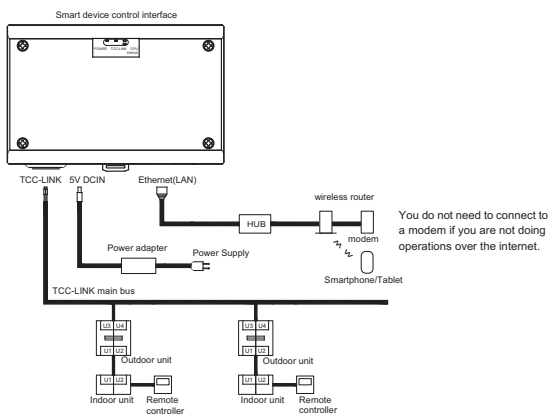

### User access

Level Function	Administrator	User
Air conditioner's display	•	•*1
Air conditioner's settings	•	•*1, *2
Users stings	•	-
Alarm	•	-*3
Schedule	•	-
Air conditioner's various settings	•	-*4
Clock settings	• (via intranet acces only)	-
Operation mode restriction	• (via intranet acces only)	-

\*1:Only the air conditioners in the "Access Area" can be displayed.

\*2:If the locking setting is enabled, you cannot do any settings.

\*3:The alarm settings for "Access Area" can only be displayed.

\*4:The settings can only be displayed.

### Toshiba AC control



Designed for commercial applications, the Toshiba AC Control App is your one-stop solution for managing up to 32 indoor units via an Android or iOS smartphone, with all main functions accessible in a single touch.

Mode (heating, cooling, ventilation, dry, auto)

Temperature set point, ambient temperature information

Fan speed (auto or manual)



On/Off

Louver control (fix or swing)

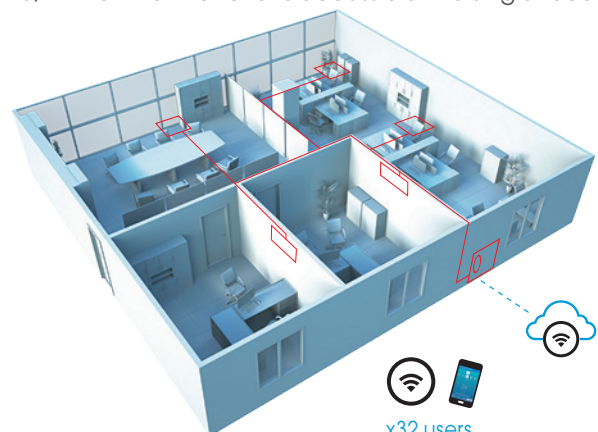

x32 users  
x1 administrator

# TOUCH SCREEN SOLUTIONS

## Features



Part number	TCB-TSC640-PY	BMS-CT2560U-E	BMS-CT5121E
Touch Screen Smart Manager			
Picture			
Dimensions (h x xp)	148x202x46mm	205x136x90mm	255x323x49mm
Compatibility	All indoor units (except hot water module, DX kit, fresh air, A2A heat exchanger)	All indoor units (except hot water module, DX kit, fresh air, A2A heat exchanger)	All indoor units, TCS-NET relay interface needed (BMS-IFLSV4E)
Connectivity	1:64	1:256	1:512
Screen	Type	Color touch screen	Capacitive color touch screen
	Dimension	7"	7"
Standard function	On/Off	•	•
	Mode (heat, cool, ventilation, dry, auto)	•	•
	Temperature setting	•	•
	Fan speed (auto, manual 5 speed)	•	•
	Air direction (swing mode or manual orientation)	•	•
Scheduling	Timer function	•	•
	Schedule function	•	•
	Return back	•	•
Advanced functions	Dual set point	•	•
	Soft cooling	•	•
	Energy save function	•	•
	Energy monitoring	•	•
Central control	Rooms naming	•	•
	Permit/prohibit function	•	•
Installation & maintenance	Group control	•	•
	Filter dirty indication	•	•
	Error display	•	•
	Error transfer by Email	•	•
	System setting	•	•
Outputs	Digital Input/output	• (Digital I/O BMS-IFDD03E needed)	• (Digital I/O BMS-IFDD03E needed)
	Web connection	•	•
Display & Interface	Interface	Menu	Menu
	Multilanguage	•	•
	Backlight display	•	•
Communication protocol	TCC Link	TU2C link	TCC link

## Installation drawings

TCB-TSC640PY

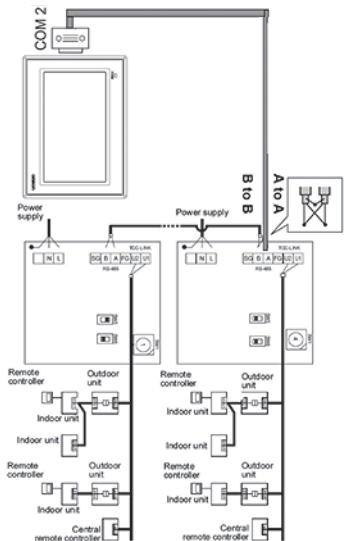

BMS-CT2560U-E

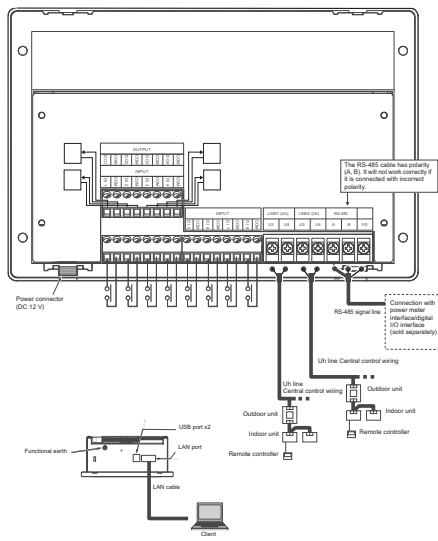

BMS-CT5121E

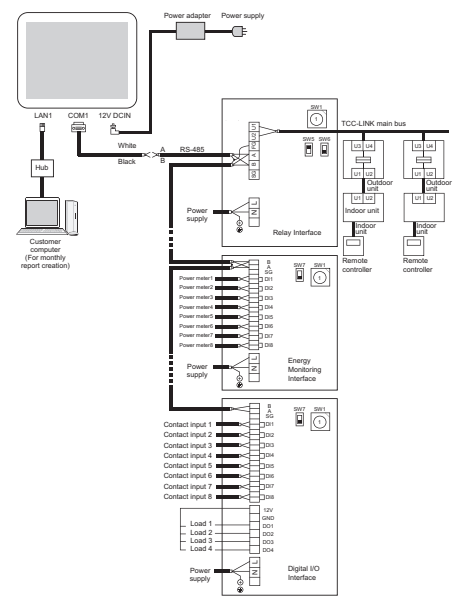

Additional PCB for outdoor units

Model name	Power peak-cut control board			External master ON/OFF control board			Output control board		
	TCB-PCDM4E			TCB-PCMO4E			TCB-PCIN4E		
System	SMMSe/SMMSu	SHRMe	Mini SMMSe	SMMSe/SMMSu	SHRMe	MINI SMMSe	SMMSe/SMMSu	SHRMe	Mini SMMSe
Power peak cut control	•	•	•						
Power peak cut extend	•	•	•						
Snowfall fan control				•	•				
External master ON/OFF control				•	•	•			
Night operation (Sound reduction) control				•	•	•			
Operation mode selection control				•	•	•			
Error/Operation output control							•	•	•
Compressor operation output							•	•	•
Operation rate display							•	•	•
Max number installed	1	1	1	4	4	2	2	2	1
Kind of digital input / output		2 / 1			6 / -			- / 8	

Additional PCB for indoors units

Windows switch sensor TCB-IFCB5PE

Function	Mode / Description	Dip Switch setting
Remote On/Off control application	Remote On-Off signal has full priority	All Bits OFF
	Priority is given to the remote ON signal	Bit 1 ON
	Priority is given to the remote OFF signal	Bit 2 ON
	Last touch priority	Bit 1 & 2 ON
Window switch application	With return back to previous operation	Bit 3 ON
	With no return back function	Bit 4 ON

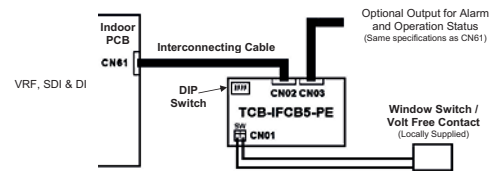

Optional connection kit TCB-PCUC2-E

SIGNAL

OUTPUT TERMINAL TB1

Signal outputs (Mode, fans status, alarm, defrost, ...) are extracted from "OUT1", "OUT2", and "OUT3".

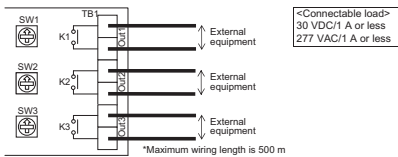

EXTERNAL

DIGITAL INPUT TERMINAL TB2

Stop air conditioner or lock local remote by inputting signal.

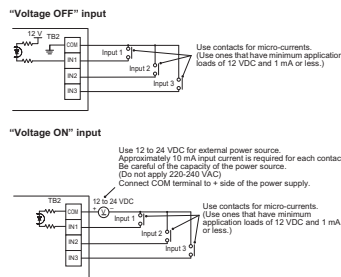

EXTERNAL

ANALOG INPUT TERMINAL TB3

Change the indoor unit's operation mode (AN1), set temperature (AN2), and blower setting (AN3) by connecting a variable resistor to the analog input terminal.

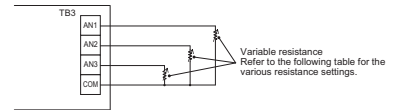





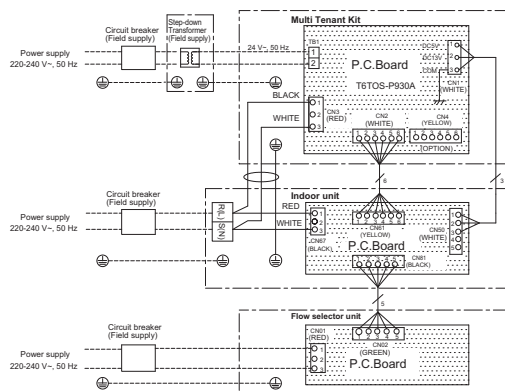

Multi tenant kit TCB-PSMT1E

For multi tenant application, this PCB maintain low voltage power during tenant absence when main power supply for the FCU is shut down.



CONTROL

## Features

Part number	BMS-IFMB0TLR-E	TCB-IFMB641TLE	BMS-IFKX0TLR-E	TO-AC-KNX-16	TO-AC-KNX-64	TCB-IFLN642TLE	BMS-IFBN640TLE	TCB-IFCB640TLE
Language	Modbus			KNX		LonWorks	Bacnet	Analogue and digital inputs
Picture								
Dimensions (hxbxw)	53x86	170x200x66	92x82x33	217x147x90		193x246x66	90x140x45	66x170x200
Compatibility	All indoor units	All indoor units (HWM, A2A heat exchanger excluded)	All indoor units (HWM, A2A heat exchanger excluded)	All indoor units (HWM, A2A heat exchanger excluded)		All indoor units (HWM, A2A heat exchanger excluded)	All indoor units (HWM excluded)	All indoor units
Connectivity	Max number of indoor units	8	64	8	16	64	64	64
	Max number of outdoor units		16			16		16
	Max number of gateways	63	15			10	1	
Command	On/Off	R/W	R/W	R/W	R/W	R/W	R/W	R/W
	Accumulated operation time		R/W					
	Mode (heat, cool, ventilation, dry, auto)	R/W	R/W	R/W	R/W	R/W	R/W	R/W
	Temperature setting	R/W (Dual set point supported)	R/W	R/W (Dual set point supported)	R/W	R/W	R/W	R/W
	Fan speed (auto, manual 5 speed)	R/W	R/W	R/W	R/W	R/W	R/W	R/W
	Air direction (swing mode or manual orientation)	R/W	R/W	R/W	R/W	R/W	R/W	R/W
	Soft cooling	R/W						
	Save operation	R/W		R/W				
	Filter dirty indication	R/W	R/W	R/W	R/W	R/W	R/W	R/W
	Room temperature	R	R	R			R	R
	Permit/Prohibit of local operation	R/W	R/W	R/W	R/W	R/W	R/W	R/W
	Temperature setting range limitation		R/W					
	Error Status	R	R	R	R	R	R	R
	Error code	R	R	R	R	R	R	
	Error address	R		R	R			
	Model name		R					
Serial number		R						
Indoor unit capacity		R						
Indoor unit type		R						
Protocol	Modbus RTU	Modbus RTU	EIB bus	EIB bus		Lontalk communication	Bacnet IP	Voltage signal
Infrastructure	RS-485	RS-485	KNX TP1	KNX TP2		Twisted pair shield cable	LAN cable (higher than Category 5, UTP)	
Requirements (Locally supplied)		Modbus master device	KNX power unit	KNX power unit		Lonworks control system		
		Modbus graphic control	ETS4 or ETS5 tool	ETS4 or ETS5 tool		Lonworks Network Card for PC Control		
Toshiba communication protocol	TCC Link	TCC Link	TCC Link	TCC Link		TCC Link	TCC Link	TCC Link

## Leak detection

**YOUR SAFETY**  
FIRST AND FOREMOST

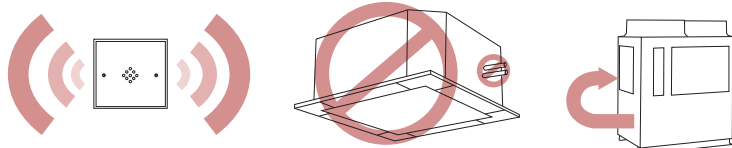

Toshiba Air Conditioning is offering a full set of leak detection solutions compliant with EN378 standard.

### > Solution 1: Audible & visible alarm + indoor unit insulation

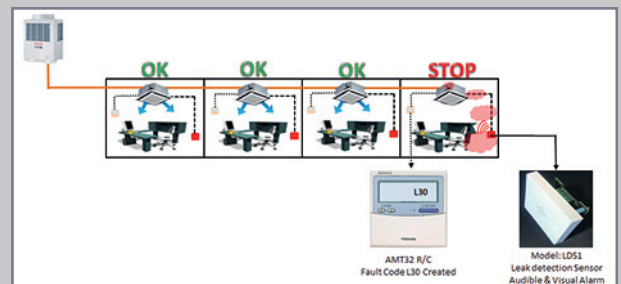

Leak detector: TCB-LDS1 (Plastic) or TCB-LDS2 (Metal)  
Flush mounting: TCB-LDSBB1 (Dry lining) or TCB-LDSBB2 (Concrete)

**Controls**

Model number	Reference	TCC-link	TU2C-Link	Description	Used with
BMS-CT256U-E	7" Touch Screen Controller	x	x	Enables full control of up to 256 indoor units	
BMS-CT5121E	12" Touch Screen Controller	x		Enables full control of up to 512 indoor units with electric billing, ML	
BMS-IFBN640TLE	BN Interface	x		BACnet Interface for LC & VRF	Enables integration with BACnet
BMS-IFDD03E	Digital I/O relay interface	x		Digital I/O relay interface	Touch screen controller, Compliant manager, Web based controller, Smart Manager
BMS-IFKX0TLR-E	1:1 KNX interface	x		Connect the system to a KNX Building Management System	Remote Control wiring
BMS-IFLSV4E	TCS-Net Relay Interface	x		Relay for integration to TCS-Net	Bacnet gateway, Touch-screens & Web based controller
BMS-IFMB0TLR-E	1:1 Modbus interface	x		Connect the system to a Modbus Building Management System	Remote Control wiring
BMS-IFWH5E	Energy monitoring relay interface	x		Energy monitoring relay interface	Touch screen controller, Compliant manager, Web based controller, Smart Manager
BMS-IWF0320E	Smart Device Control Interface	x		Enables full control of up to 32 indoor units by using Toshiba AC app (Smart phone & Tablet)	
BMS-SM1281ETLE	Smart BMS Manager with data analyzer	x		Enables full control of up to 128 indoor units with Energy Monitoring and Advanced Control Options.	network 1:1 model connection interface required for DI/SDI (Excluding high-wall type)
NRB-1HE	Remote ON/OFF adapter	x		Allows ON/OFF control	All Air-to-air heat exchangers
NRC-01HE	Wired Remote Controller	x		Air-to-air heat exchanger remote controller, including with DX coil and humidifiers models	Air-to-air heat exchangers and Air-to-air heat exchangers with DX coil
RBC-AMS41E	Remote controller with schedule timer	x		Indoor unit operation with schedule timer (7-days) allowing to program 8 functions/day + clock display	
RBC-AMSU51-EN/ES	Design remote Controller with schedule timer	x	x	Multi-Language LCD display, a built-in 7-Day timer, Energy Saving options and return back function, Dual set points, and Soft cooling. EN = English, Italian, Polish, Greek, Russian, Turkish, ES = English, Spanish, Portuguese, French, Dutch, German	
RBC-AMTU31-E	Wired Remote Controller	x	x	Main wired remote controller	
RBC-AMT32-E	Wired Remote Controller	x		Main wired remote controller	
RBC-AS41E	Simplified Wired Remote Controller	x		Dedicated for hotel and domestic applications	
RBC-AXU31C-E	Infra-red Remote Kit	x	x	Wireless remote controller	All ceiling units and one-way cassettes (SH series)
RBC-AXU31U-E	Wireless remote unit kit	x	x	Wireless remote unit kit for 4-way cassette	4 way cassette series 4 & RBC-U31PGP(W)-E panel
RBC-AX33UY-P-E	Wireless remote kit	x	x	Wireless remote kit for YHP 1-way cassette	
RBC-AXU31-E	Infra-red Remote Kit	x	x	Wireless remote controller	All units
TCB-IFCB-4E2	Remote location On/Off Control Box	x		Enables remote location On/Off control	
TCB-IFCB5-PE	Window Switch & Remote on/off	x		Ensure the indoor unit not operate when outside window is open or for Door Entry systems	
TCB-IFCB640TLE	Analog interface	x		Control & monitoring up to 64 IU on TCC-link	Combination with TCB-IFCG1TLE
TCB-IFCG1TLE	General purpose interface	x		enables control of A/C by the DI/DO and AI/AO	Combination with TCB-IFCB640TLE
TCB-IFLN642TLE	LN interface	x		Allows control of 64 indoor units from a Lonworks based BMS	
TCB-IFMB641TLE	Modbus interface box	x		Connect the system to a Modbus Building Management System	
TCB-KBCN32VEE	Connectors	x		For CN32	
TCB-KBCN60OPE	Connectors	x		For CN60	
TCB-KBCN61HAE	Connectors	x		For CN61	
TCB-KBCN70OAE	Connectors	x		For CN70	
TCB-KBCN73DEE	Connectors	x		For CN73	
TCB-KBCN80EXE	Connectors	x		For CN80	
TCB-PCDM4E	Application Control PC Board	x		Power Peak Cut Control	
TCB-PCIN4E	Application Control PC Board	x		Error/Individual compressor Operation Output Control Board	
TCB-PCMO4E	Application Control PC Board	x		External Master ON/OFF Control Board	
TCB-PCUC2E	Optional connection kit	x			
TCB-PSMT1E	Optional connector kit	x		Multi-Tenant Kit for VRF Systems	SMMS-e, SHRM-e and Mini-SMMS Indoor Units (refer to I/M for more details of connectable Indoor units)
TCB-PX100-PE	Enclosure for the Window Switch / Remote On/Off	x		For use when the Window Switch / Remote On/Off Accessory cannot fit within the AC unit, eg. High Walls	For use with TCB-IFCB5-PE
TCB-PX30MUE	E-Box Extension Enclosure	x		For 1:1 Model connection I/F and Window Switch / Remote On/Off PCB	4-Way Cassettes only & TCB-IFCB5-PE
TCB-PX40MUE	E-Box Extension Enclosure	x		For 1:1 Model connection I/F and Window Switch / Remote On/Off PCB	4-Way Compact Cassettes only & TCB-IFCB5-PE
TCB-SC640U-E	Centralized remote control	x	x	Up to 64 indoor units	
TCB-TC41U-E	Remote temperature sensor	x	x	Remote temperature sensor for cassette & duct	
RBC-ASC11U-E	Wired Remote Controller	x	x	Main wired remote controller	
RBC-ASC11-E	Wired Remote Controller	x		Main wired remote controller	

CONTROL

**> Solution 2: Audible & visible alarm only**

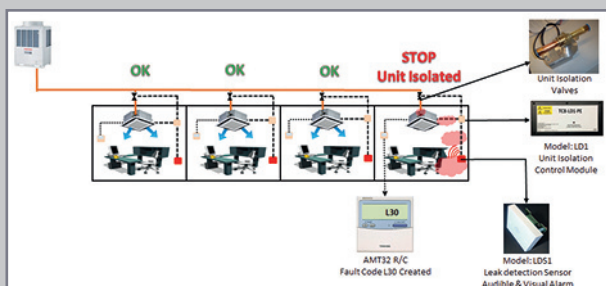

Leak detector: TCB-LDS1 (Plastic) or TCB-LDS2 (Metal)  
 Flush mounting: TCB-LDSBB1 (Dry lining) or TCB-LDSBB2 (Concrete)  
 Isolation valve: TCB-AW17861/7  
 Control module: TCB-LD1

**> Solution 3: Audible & visible alarm + refrigerant pump down**

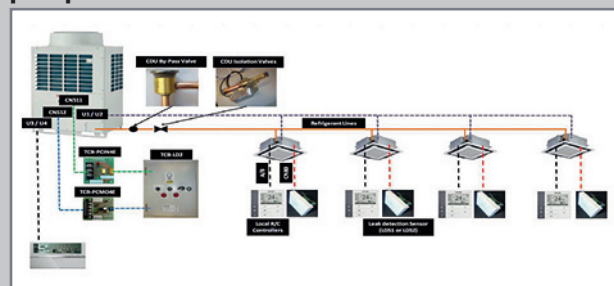



Leak detector: TCB-LDS1 (plastic) or TCB-LDS2 (metal)  
 Flush mounting: TCB-LDSBB1 (dry lining) or TCB-LDSBB2 (concret)  
 One per system: Isolation valve: TCB-AW17861/7  
 Control module: TCB-LD1

# ACCESSORIES

## Indoor units accessories

Indoor unit type	Parts name	Model name	COMPLY WITH VRF FCU	Notes	Remarks	
4-way Air Discharge cassette type	Standard panel	RBC-U32PGP-E	MMU-UP***1HP-E/TR	Required accessory		
	Fresh air and filter chamber	TCB-GFC1602UE		For fresh air inlet box		
	Fresh air inlet box	TCB-GB1602UE		For fresh air intake by using the knockout hole of Fresh air and filter chamber. (dia.=100 mm)	Use with TCB-GFC1602UE	
	Auxiliary fresh air flange	TCB-FF101URE2	MMU-UP***1HP-E/TR	For easy fresh air intake by using the knockout hole of indoor unit. (dia.=100mm)		
	Spacer for height adjustment	TCB-SP1602UE		height 50 mm		
	Air discharge direction kit	TCB-BC1602UE		Air direction change by cutting off air discharge port. (3 pcs.)		
Compact 4-way cassette type	Decoration panel	RBC-UM21PG(W)-E		Required accessory		
	Motion Sensor	TCB-SIR41UM-E	MMU-UP***1MH-E/TR		Wireless remote controller kit (RBC-AX32UM(W)-E) and Occupancy sensor cannot be used on the same indoor unit.	
2-way cassette type	Decoration panel	RBC-UW283PG(W)-E RBC-UW803PG(W)-E RBC-UW1403PG(W)-E	MMU-UP0071WH-E/TR to MMU-UP0151WH-E/TR MMU-UP0181WH-E/TR to MMU-UP0301WH-E/TR MMU-UP0361WH-E/TR to MMU-UP0561WH-E/TR	Required accessory		
	Auxiliary fresh air flange	TCB-FF151US-E	MMU-UP***1WH-E/TR	For easy fresh air intake by using the knockout hole of indoor unit		
	Filter chamber	TCB-FC283UW-E TCB-FC803UW-E TCB-FC1403UW-E	MMU-UP0071WH-E/TR to MMU-UP0151WH-E/TR MMU-UP0181WH-E/TR to MMU-UP0301WH-E/TR MMU-UP0361WH-E/TR to MMU-UP0561WH-E/TR			
	Super Long life filter	TCB-LF283UW-E TCB-LF803UW-E TCB-LF1403UW-E	MMU-UP0071WH-E/TR to MMU-UP0151WH-E/TR MMU-UP0181WH-E/TR to MMU-UP0301WH-E/TR MMU-UP0361WH-E/TR to MMU-UP0561WH-E/TR	For use with filter chamber	Use with TCB-FC283UW-E Use with TCB-FC803UW-E Use with TCB-LF1403UW-E	
	Decoration panel	RBC-UY32P-E RBC-US21PGE	MMU-UP_1YHP-E/TR/	Required accessory		
1-way cassette type	Front air discharge unit	TCB-BUS21WHE	MMU-UP0151/0181/0241SH-E/TR			
	Auxiliary fresh air flange	TCB-FF101URE2		For easy fresh air intake by using the knockout hole of indoor unit. (dia.=100mm)		
	Air purifier kit	TCB-EAPC1UYHP-E	MMU-UP-1YHP-E/TR	Set of Plasma Air Purifier, Dust sensor, Air quality indicator and Wireless receiver		
	Occupancy sensor	TCB-SIR41UYYP-E	MMU-UP-1YHP-E/TR	Occupancy sensor for 1Way cassette	Cannot be match with Wireless receiver Kit	
	Wireless reciever kit	RBC-AX33UYYP-E	MMU-UP-1YHP-E/TR	Wireless RC kit for 1Way cassette	Cannot be match with Occupancy sensor	
Slim duct type	Auxiliary fresh air flange	TCB-FF101URE2	MMU-UP***1SPH-E/TR	For easy fresh air intake by using the knockout hole of indoor unit. (dia.=100mm)		
Concealed duct type	Spigot shaped flange	TCB-SF56C6BE	MMD-UP0071BHP-E/TR to MMD-UP0181BHP-E/TR			
		TCB-SF80C6BE	MMD-UP0241BHP-E/TR to MMD-UP0301BHP-E/TR			
		TCB-SF160C6BE	MMD-UP0361BHP-E/TR to MMD-UP0561BHP-E/TR			
"Concealed Duct high static pressure type"	Long life filter kit	TCB-LK801D-E	MMD-UP0181HP-E/TR to MMD-UP0271HP-E/TR			
		TCB-LK1401D-E	MMD-UP0361HP-E/TR to MMD-UP0561HP-E/TR			
	Spigot shaped flange	TCB-LK2801DP-E	MMD-UP0721/0961HP-E/TR			
		TCB-SF80C6BE	MMD-UP0181HP-E/TR to MMD-UP0271HP-E/TR			
		TCB-SF160C6BE	MMD-UP0361HP-E/TR to MMD-UP0561HP-E/TR			
Auxiliary fresh air flange	TCB-FF151US-E	MMD-UP***1HP-E/TR				
Drain Pump kit	TCB-DP40DPE	MMD-UP***1HP-E/TR				
High Wall	PMV Kit	RBM-PMV0361U-E		For FCU capacity 0.3-1.3HP	Suitable for high wall 1 serie with or without embedded PMV	
		RBM-PMV0901U-E		For FCU capacity 1.7-2.5HP		
Ceiling-suspended type	Drain pump kit	TCB-DP31CE	MMC-UP***1HP-E/TR			
	Elbow Piping kit	TCB-KP13CE TCB-KP23CE	MMC-UP0151/0181HP-E/TR MMC-UP0241HP-E/TR to MMC-UP0561HP-E/TR	Lift up to 600 mm	Use TCB-KP13, 23CE	
Fresh air intake type	High-efficiency filter 65	TCB-UFM0481D-E	MMD-UP0481HF-E/TR	Dust collecting effect: 65% (NBS Colorimetric method)	Use with TCB-FC0481DF-E	
		TCB-UFM1281D-E	MMD-UP0721HF-E/TR to MMD-UP1281HF-E/TR		Use with TCB-FC1281DF-E	
	High-efficiency filter 90	TCB-UFH0481D-E	MMD-UP0481HF-E/TR	Dust collecting effect: 90% (NBS Colorimetric method)	Use with TCB-FC0481DF-E	
		TCB-UFH1281D-E	MMD-UP0721HF-E/TR to MMD-UP1281HF-E/TR		Use with TCB-FC1281DF-E	
	Stand alone long life prefilter	TCK-LK1401D-E	MMD-UP0481HF-E/TR			
		TCK-LK2801DP-E	MMD-UP0721HF-E/TR to MMD-UP1281HF-E/TR			
	High efficiency long life prefilter	TCK-LK1401D-E (*2)	MMD-UP0481HF-E/TR		Use with TCB-FC0481DF-E	
Filter chamber	TCK-PF1281DF-E	MMD-UP0721HF-E/TR to MMD-UP1281HF-E/TR		Use with TCB-FC1281DF-E		
Air-to-air heat exchanger with DX coil	Drain pump kit	TCB-FC0481DF-E	MMD-UP0481HF-E/TR			
		TCB-FC1281DF-E	MMD-UP0721HF-E/TR to MMD-UP1281HF-E/TR	For high efficiency filter or long life prefilter		
		TCB-DP40DFP-E	All models	Lift up to 330 mm		
		TCB-DR31HEXE	MMD-VN502/802/1002HEXE & MMD-VNK502/802/1002HEXE	Lift up to 330 mm		

## Refrigerant accessories

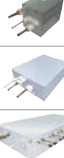
Compatible Mini SMMS-e, SMMS-e & SMMS-u	Compatible SHRM-e	Specification	Picture	Total capacity codes
RBM-BY55E RBM-BY105E RBM-BY205E RBM-BY305E RBM-BY405E	RBM-BY55FE RBM-BY105FE RBM-BY205FE RBM-BY305FE	Branching joint		under 6.4hp from 6.4 to 14.2hp from 14.2 to 25.2hp from 25.2 to 61.2hp 61.2hp or more
RBM-HY1043E RBM-HY2043E RBM-HY1083E RBM-HY2083E	RBM-HY1043FE RBM-HY2043FE RBM-HY1083FE RBM-HY2083FE	Headers branching four-way Headers branching eight-way		< 14.2 HP < 14.2 - 25.2 HP < 14.2 HP < 14.2 - 25.2 HP
RBM-BT14E RBM-BT24E RBM-BT34E	RBM-BT14FE RBM-BT24FE	Joints for connection of outdoor units		< 26 HP system capacity >26 <62 HP system capacity >62 HP system capacity
	RBM-Y1123FE RBM-Y1803FE RBM-Y2803FE RBM-Y1124FE RBM-Y1804FE RBM-Y2804FE RBM-Y1801F4PE RBM-Y1801F6PE	Flow selector unit Flow selector unit long piping Multi-port flow selector unit		< 4.0 HP indoor units < 4.0 - 6.4 HP indoor units < 6.4 - 10.0 HP indoor units < 4.0 HP indoor units < 4.0 - 6.4 HP indoor units < 6.4 - 10.0 HP indoor units < 6.4 HP indoor units x 4 port < 6.4 HP indoor units x 6 port



Mini VRF piping

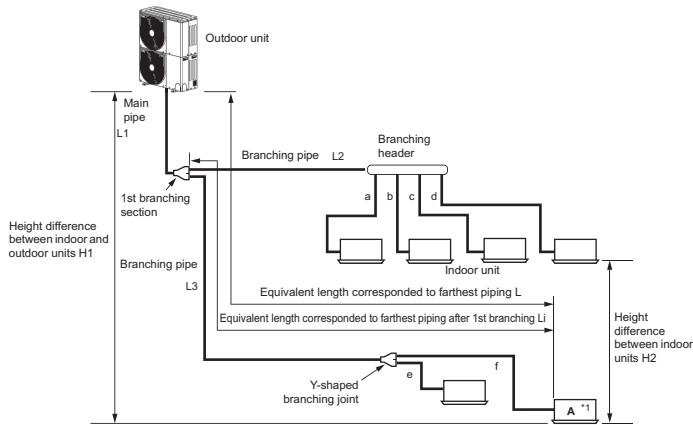

SHRM-e piping

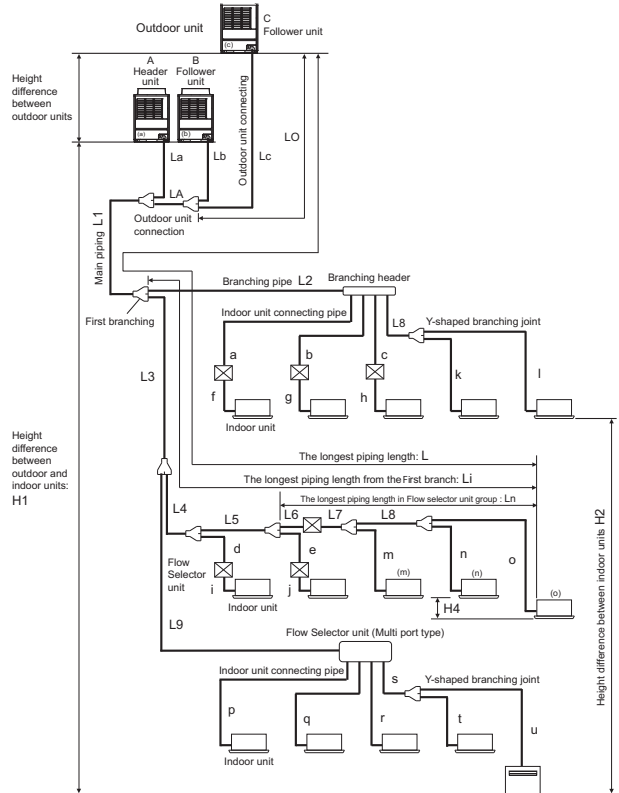

SMMS-e piping

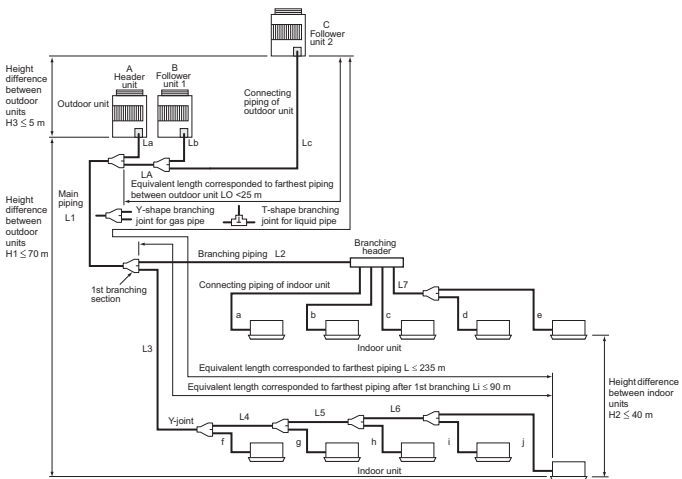

SMMS-u piping

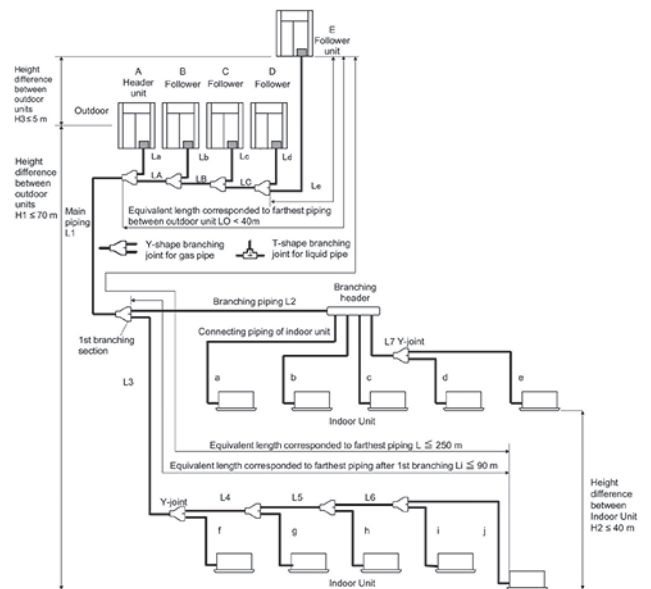

CONTROL

## SYSTEM RESTRICTION

		SMMS-u	SMMS-e		SHRM-e
			Standard	Stand alone	
Outdoor unit combination		Up to 5 units	Up to 3 units	1 unit	Up to 3 units
Total capacity of outdoor units		Up to 120HP	Up to 60HP	Up to 12HP	Up to 54HP
Indoor unit connection		Up to 128 units	Up to 64 units	Up to 27 units	Up to 64 units (54 with central control)
Total capacity of indoor units	H2 ≤ 15m	200%		135%	135%*
	15m > H2	105%		105%	105%

\* 20HP & 40HP: 125% 38HP: 130%

T-shape branching joint for liquid pipe

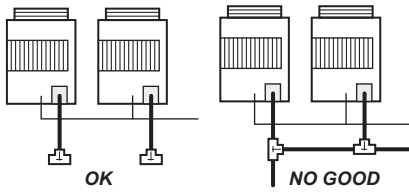

Y-shape branching joint for gas pipe

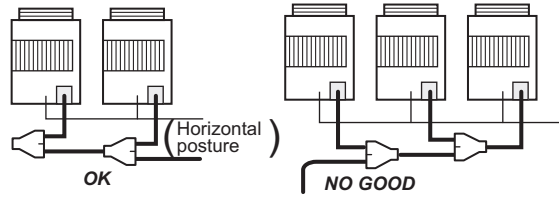

## CAUTION FOR INSTALLATION

Be careful of the connecting arrangement of the header unit and follower units. Set the outdoor units in order of capacity from the one with the largest capacity.

At a level position

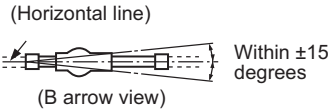
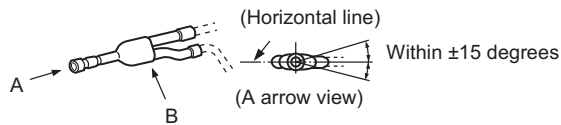

Do not connect a branch unit vertically.

## FREE BRANCHING SYSTEM

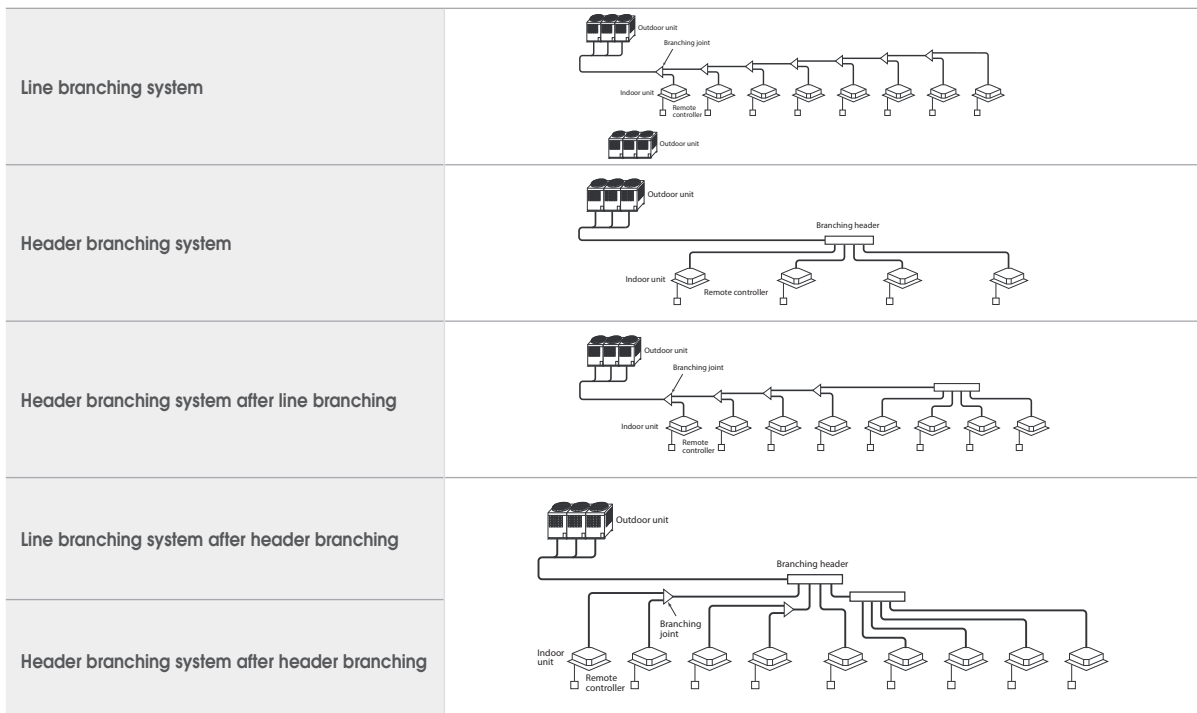

Electrical wiring

Mini SMMS-e  
Outdoor unit  
power source

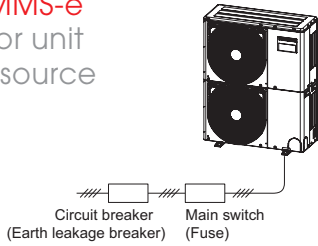

SMMS-u/SMMS-e/SHRM-e  
Outdoor power source

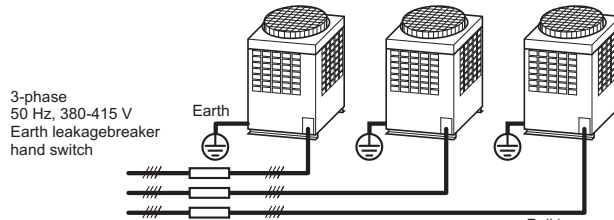

Indoor unit power source

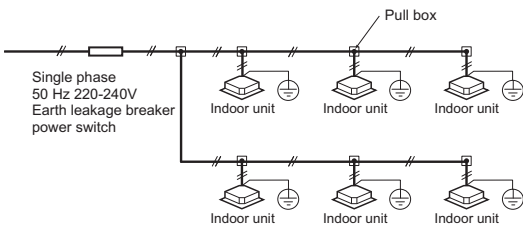

Indoor power source

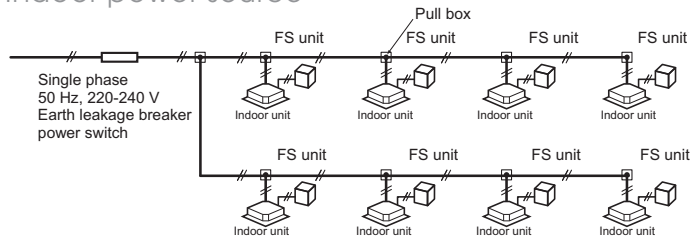

FS unit only applicable for SHRM-e. Multiple and 4 series FS boxes need to be powered separately from indoor unit.

Sound pressure level measurement

MINI SMMS

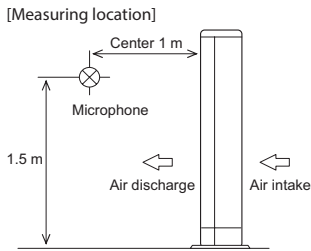

SMMS-e & SHRM-e

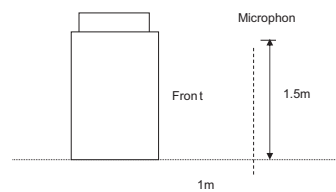

COMPACT 4-WAY CASSETTE & 4-WAY CASSETTE & 2-WAY CASSETTE & 1-WAY CASSETTE

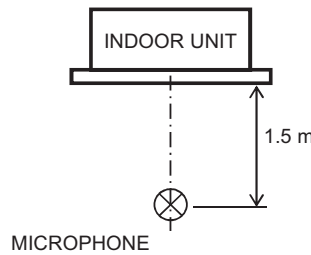

HIGH-WALL & CEILING

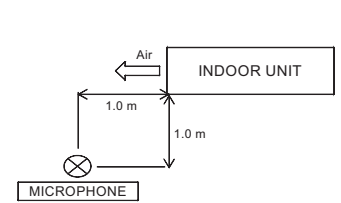

CONSOLE & BIFLOW CONSOLE

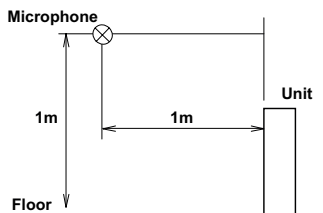

CONCEALED CHASSIS

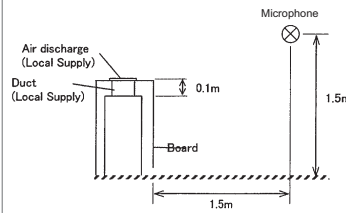

FLOOR STANDING

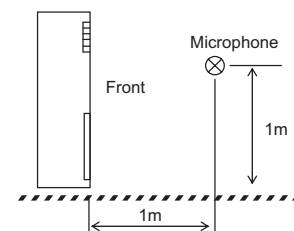

SLIM DUCT & STANDARD DUCT & HIGH STATIC DUCT

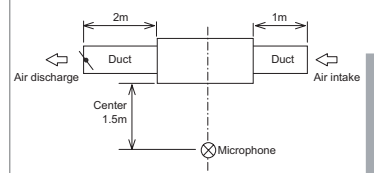

HIGH STATIC DUCT SIZES 72 & 96

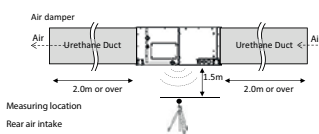

FRESH AIR

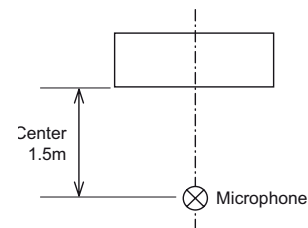

A2A HEAT EXCHANGER

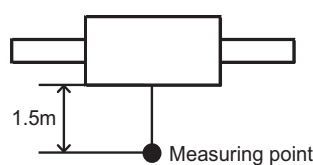

HOT WATER MODULE (MID & HIGH TEMPERATURE)

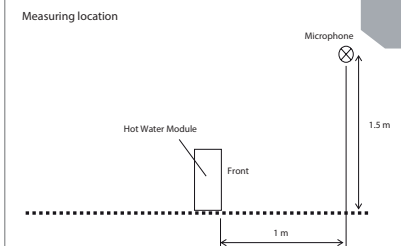

**SELECTION TOOL**



Software main screen

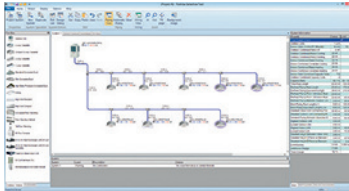

Toshiba Selection software has been fully designed, with a user-friendly interface allowing novice and expert users alike to create simple, yet detailed VRF system schematics. It is highly versatile, allowing the level of detail to be tailored to suit customer requirements. The software also allows the user to specify pricing strategy and create additional interim reports, including any diagrams and schematics required. Final detailed reports can then be produced and sent to customers in PDF format or in more complex files, such as AutoCAD DXF allowing simple integration into their existing software packages.

Project fully customizable

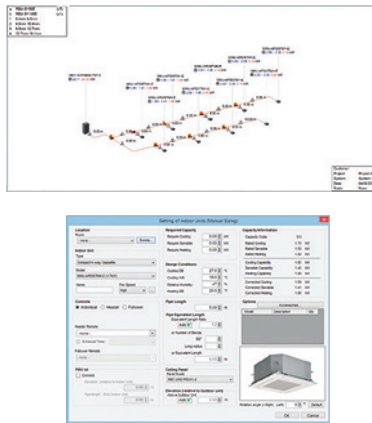

Complete report

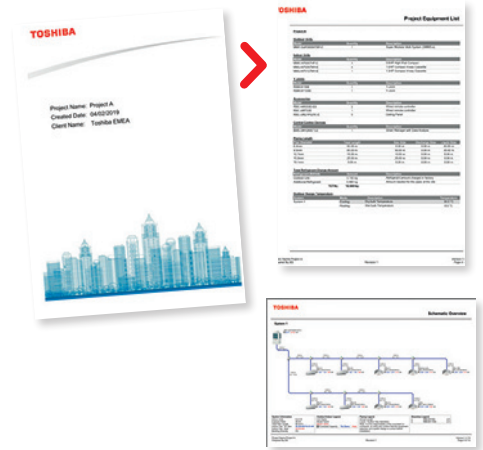

**SERVICE TOOL**

Save time during commissioning and maintenance. Choose between the "Wave Tool Advance" using Smartphone NFC connection or the link adaptor connected to the outdoor or indoor unit.

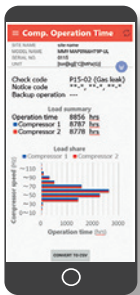
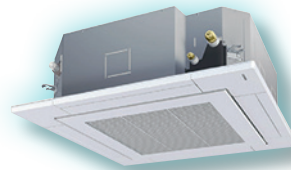

Wireless connection using smartphone\* NFC technology to collect system data

\* Please contact Toshiba for Android® phone compatibility list.

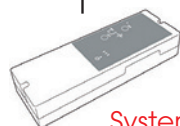

System operation self record using link adaptor

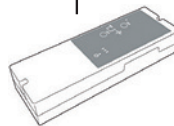

Get access to system data indoor using link adaptor



Direct USB connection to get access to system data



## *Better Air Solutions*

Through our commitment to world-class **efficiency**, versatile **scalability** and leading **quality**, Toshiba Air Conditioning advances leading-edge technologies to find the most forward-thinking solutions possible for your world.



TOSHIBA Air Conditioning participates in the ECP program for Comfort Air Conditioner (AC).  
Check ongoing validity of certificate:  
[www.eurovent-certification.com](http://www.eurovent-certification.com)

### **AHI CARRIER SOUTH EASTERN EUROPE AIR CONDITIONING SINGLE MEMBER S.A.**

#### **HEADQUARTERS**

18, Kifissou Ave. 104 42 - Athens, Tel.: +30 210 6796300,  
Fax: +30 210 6796390, [www.toshiba-aircon.gr](http://www.toshiba-aircon.gr)

#### **THESSALONIKI BRANCH**

5, Ag. Georgiou Str., Cosmos Offices, 570 01 - Patriarhiko Pileas,  
Thessaloniki, Tel.: +30 231 3080430, Fax: +30 231 3080435

#### **AHI CARRIER HVAC BULGARIA EOOD**

Trade Center Europe, Building 6, floor 3, office 6, 7 Iskarsko Shose Blvd.  
Sofia, 1528 - Bulgaria, Tel.: +35 929483960 Fax: +35 929483990,  
[www.toshiba-aircon.bg](http://www.toshiba-aircon.bg)

#### **AHI CARRIER ROMANIA SRL**

Intrarea Nestorei 1, Corp B, Et. 5, Sector 4, Cladirea River Plaza,  
RO-040295 Bucuresti, Romania, Tel.: +40 214 050751,  
Fax: + 40 214 050753, [www.toshiba-hvac.ro](http://www.toshiba-hvac.ro)